

Mikroprzełącznik Z-15GQ21-B nr kat. 00665

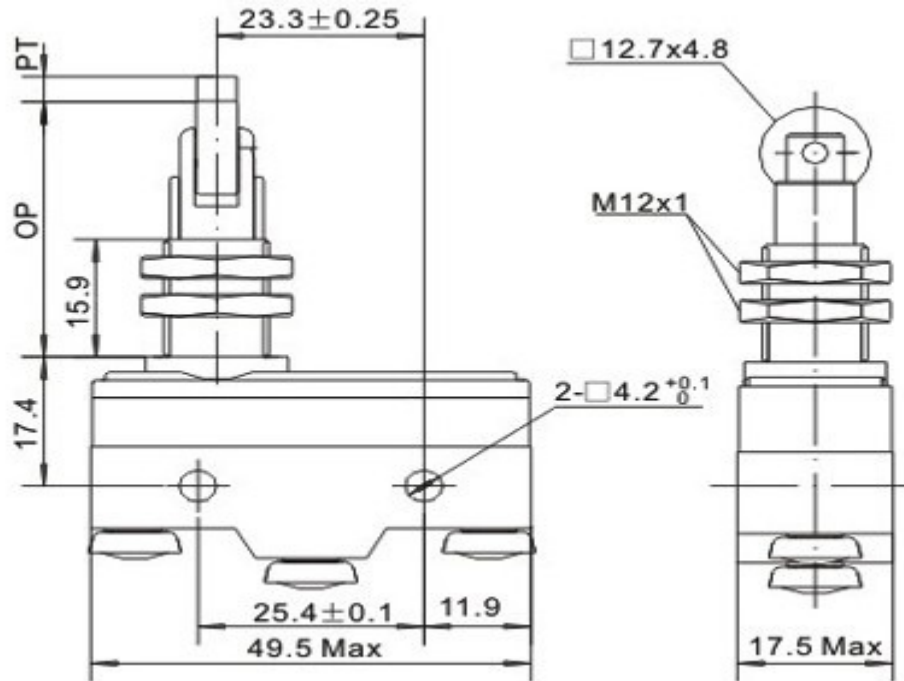

Feature:

Wide range of operation speed

High accuracy and waterproof

Variety of levers

Widely used in appliance, electronic equipment, automatic machine, communication equipment, car electric, apparatus and instrument, electro motion tool ect.

Specification

Item		Data
Operation speed		0.1mm-1m/s
Operation frequency	Mechanical	240time/min
	Electrical	20time/min
Insulation resistance		100MΩ(above)(DC500V)
Contact resistance		25MΩ Initial value
Withstand voltage	Non-connection wire	1500VAC
	Every terminal	2000VAC
Vibration	Misoperation	10-55Hz (Amplitude)1.5mm
Impact	Durable	1000m/s
	Misoperation	300m/s
Life	Electical	100,00(above)
	Mechanical	1,000,000(baove)
Protection degree		IP40/IP65
Ambient operating temperature		-25-80°C
Humidity		<85%