

GP Batteries

Data Sheet

Model No.: GP60BVH

Type	: Rechargeable Nickel Metal Hydride Button Cell	
Nominal Dimension	: $\Phi = 15.5\text{mm}$ H = 6.3mm	
Applications	: Recommended discharge current 0.6 to 30mA	
Nominal Voltage	: 1.2V	
Capacity	: Minimum : 60mAh Typical : 63mAh when discharge at 0.2C to 1.0V at 20°C	
Charging Condition	: 6mA for 16hrs at 20°C	
Service Life	: >500 cycles (IEC standard)	
Continuous Overcharge	: 6mA maximum current for 1 year No conspicuous deformation and/or leakage	
Weight	: 3.6g	
Internal Resistance	: Under 500m Ω upon fully charged	
Max. Charging Voltage	: 1.5V at 6mA charging	
Ambient Temperature Range	Standard Charging	: 0 to 45°C
	Discharging	: 0 to 45°C
	Storage	: -20 to 45°C

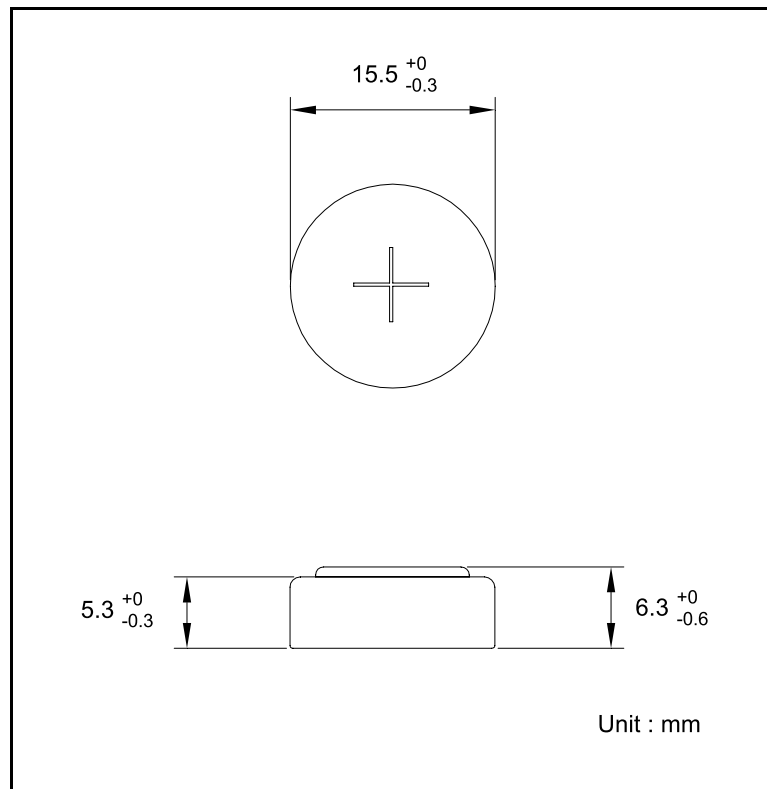

Charge Characteristics

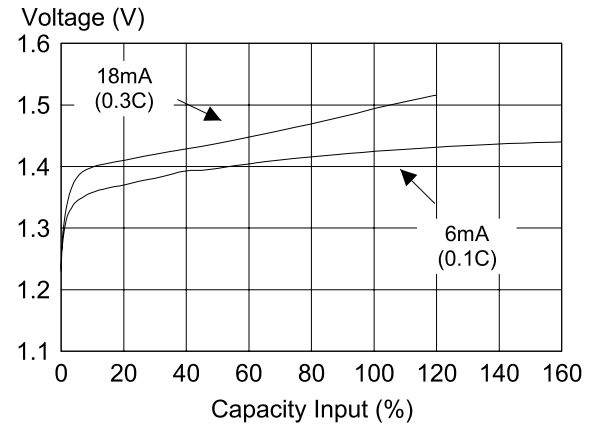

Discharge Characteristics

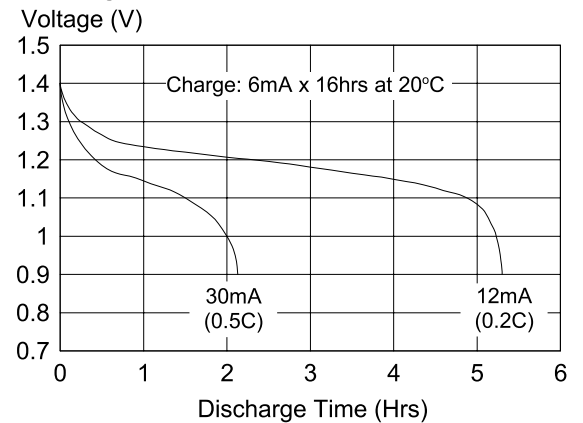

Charge Retention Characteristics

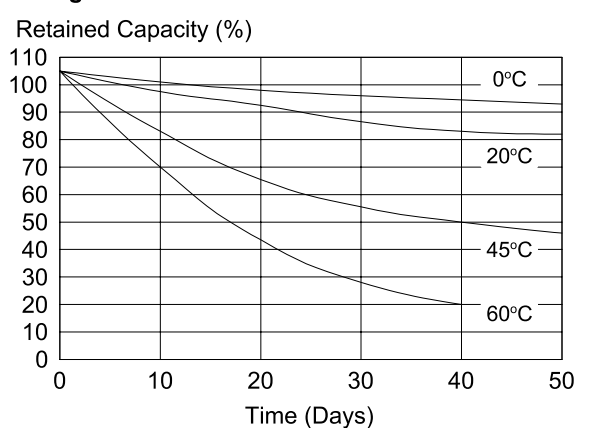

* The information (subject to change without prior notice) contained in this document is for reference only and should not be used as a basis for product guarantee or warranty. For applications other than those described here, please consult your nearest GP Sales and Marketing Office or Distributors.