

PHOTOELECTRIC SWITCHES

Features

- Diameter M18 x1mm
- Supply voltage 12-30 VDC
- Short circuit protected
- Conforming to IP66
- Fast response



Specifications

Item	Standard
Light Source	Infrared LED (940nm)
Detector	Photo-transistor
Operating Indicator	Red LED, Light when output energized
Sealing	Conforming to IP66(IEC)
Extraneous Light Immunity	300 Lux 3000
Housing Materials	Plastic Housing :ABS resin Metal Housing:Brass Plastic Nut:PBT Metal Nut:Brass Lens:Polycarbonate or PMMA
Ambient Humidity	35-85% RH
Storage Temperature	-30°C to +70°C(-22° F to 158° F)
Cable Length	2m(6.5' Three Conductor Cable)
Weight	About 120g (4.3 oz.) for plastic Housing

Product Selection

□- □ □ □
1 2 3 4

1. TYPE

WE	DC, Metal housing 0.5ms response time
WM	DC, Plastic, housing
WA	AC, Plastic housing
WR	DC, Metal housing

3. OUTPUT TYPES

2	Universal
3	NPN open collector
4	PNP open collector
5	AC three wire
6	AC two wire

2. SENSITIVITY & DETECTION DISTANCE

T	Thru-Beam.
M	Retro-Reflective.
RXA	Diffuse Reflective.
RXB	Diffuse Reflective.
U	Background Suppression

4. Complimentary outputs





L	Light on
D	Dark on

HIGHLY

D12

Design, specifications are subject to change without notice.

PHOTOELECTRIC SWITCHES

Model item Type	WM Series DC Type			WA Series DC Type		
	Detecting distance	NPN Output	PNP Output	Detecting distance	AC 3 Wires	AC 2 Wires
 Thru-Beam	10M	WM-T3AD	WM-T4AD	10M	WA-T5AD	WA-T6AD
 Retro-Reflective	2.4M	WM-M3D WM-M3L	WM-M4D WM-M4L	2M	WA-M5D WA-M5L	WA-M6D WA-M6L
 Diffuse Reflective	200mm	WM-R3AL	WM-R4AL	200mm	WA-R5AL	WA-R6AL
 Diffuse Reflective	80mm	WM-R3BL	WM-R4BL	80mm	WA-R5BL	WA-R6BL
 Background Suppression	45mm	WM-U3L	WM-U4L	45mm	WA-U5L	WA-U6L

GENERAL SPECIFICATION

Operating Voltage	12-30 VDC
Operating Principle	Thru-Beam
Response Time	10ms
Power-on Reset Time	30ms
Max. Load Current	200mA
Sealing	Conforming to IP66(IEC)
Housing Material	Brass. Ni plated
Cable Length	2 meter
Circuit Protection	1.Output short circuit 2.Reverse polarity of supply voltage

Model Item	Output Circuit	NPN Open Coll.	
		20M	30M
Detecting Distancce		WR-T3D	WR-T4D
		WR-T3AD	WR-T4AD

Dimensions

WE Series DC Type Plastic
WM Series DC Type metal

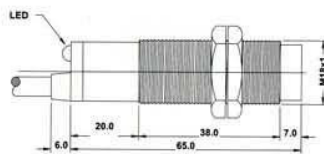

Reflector

PR-272W

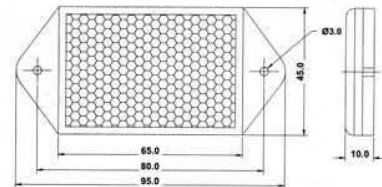

WA Series AC Type WA Type

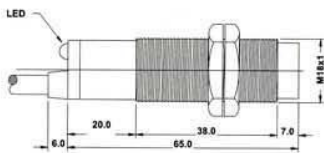

PR-272S

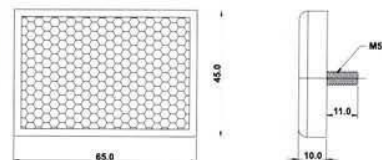

HIGHLY

D13

Design, specifications are subject to change without notice.

PHOTOELECTRIC SWITCHES

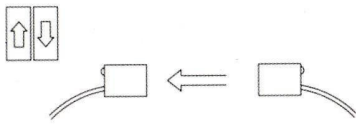
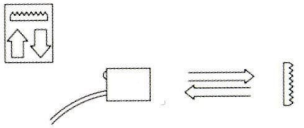
Operating Principle	Thru-Beam		Retro-Reflective	
				
Feature	<ul style="list-style-type: none"> ● Long range detection ● Small object detectable ● 1.2 ms response time 		<ul style="list-style-type: none"> ● One-side wiring ● Easy to align ● Fast response 	
Detecting Distance	0-5 meter		0-2 meter(*1)	
Detecting Capability	>8mm dia. opaque		>10-40mm dia. Opaque(*2)	
Hysteresis	N/N		N/A	
Mode of Operation	Dark ON			
Max. Switching Rate (Response time)	400 Hz (1.2 ms)		250 Hz (2 ms)	
Power-on Reset Time	20 ms			
Operating Voltage	12-30 VDC			
Current Consumption	20 mA(receiver) 25 mA(transmitter)		25 mA	
Circuit Protection	1. Output short circuit 2. Reverse polarity of supply voltage			
Max. Load Current	120 mA			
Output Residue Voltage	Less than 1.5V (at load current = 120 mA)			
Output Circuit	NPN	PNP	NPN	PNP
Model Item*4	WE-T3AD	WE-T4AD	WE-M3D	WE-M4D

Note : *1 with reflector PR-272S or PR-272W, active area $A_r = 2240\text{mm}^2$.

*2 refer to SENSING PERFORMANCE.

SENSING PERFORMANCE

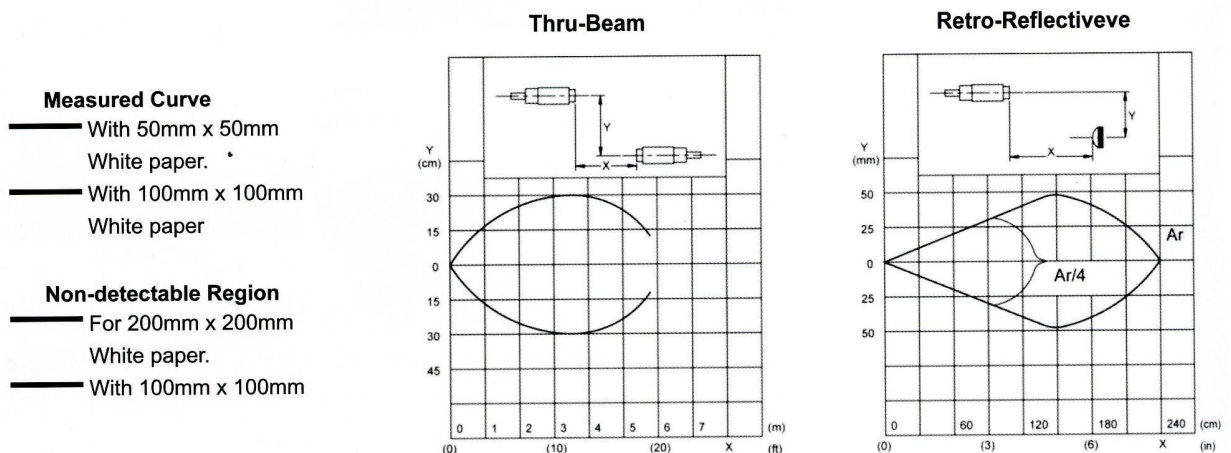

HIGHLY

D14

Design, specifications are subject to change without notice.

PHOTOELECTRIC SWITCHES

Diffuse Reflective		Diffuse Reflective		Background Suppression	
<ul style="list-style-type: none"> ● Transparent material detection possible ● Easy to use ● Fast response 		<ul style="list-style-type: none"> ● Fo restricted area applications ● Max sensitivity range at 15-40 mm(*3) 		<ul style="list-style-type: none"> ● Background reflections heavily suppressed ● Max sensitivity range at 18-22 mm(*3) 	
0-200 mm(-2)		0-80 mm (*2)		10-30 mm (*2)	
See SENSING PERFORMANCE(measured curve & non-detectable region)					
20%		N/N		N/A	
Light ON					
250 Hz (2ms)					
20 ms					
12-30 VDC					
25 mA					
<ol style="list-style-type: none"> 1. Output short circuit 2. Reverse polarity of supply voltage 					
120 mA					
Less than 1.5V (at load current = 120 mA)					
NPN	PNP	NPN	PNP	NPN	PNP
WE-R3AL	WE-R4AL	WE-R3BL	WE-R4BL	WE-U3L	WE-U4L

Note : *3 max. sensitivity range is measured with 50mm x 50mm black paper.

*4 WE series : DC type , plastic housing; WM series : DC type , metal housing; WA series : AC type , plastic housing.

SENSING PERFORMANCE

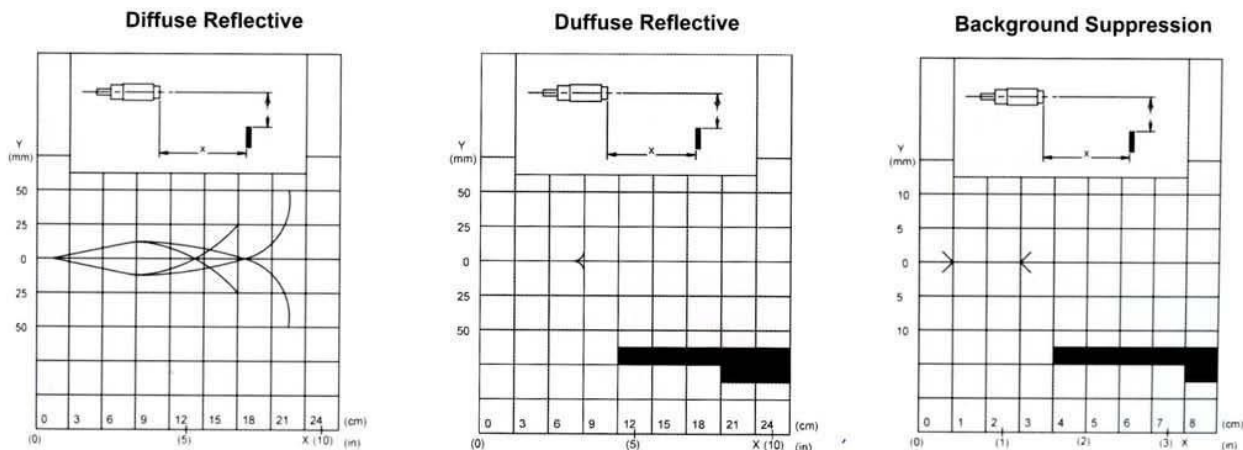

HIGHLY

D15

Design, specifications are subject to change without notice.