

5

4

3

2

1

D

C

B

A

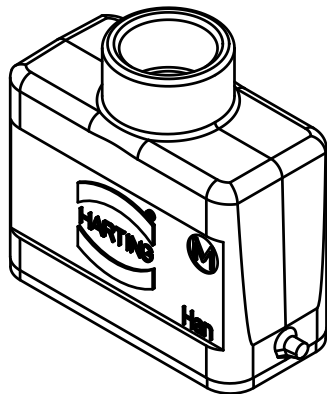
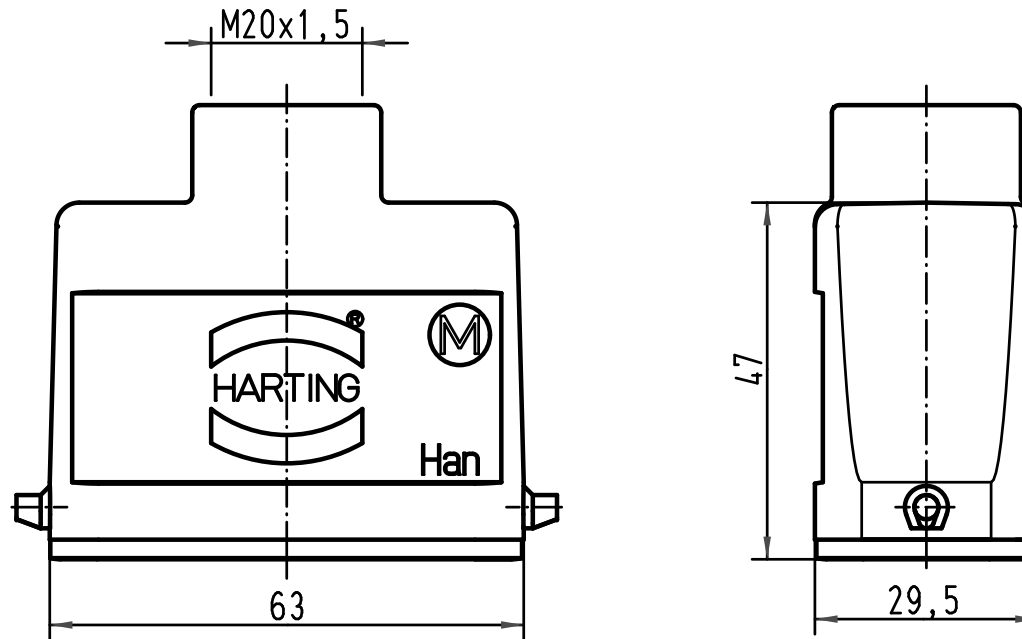

All Dimensions in mm Original Size DIN A 4			Techn. Character.			Nicht tolerierte Maße/Free size tolerances		
				Dat.	Name	Maßstab/Scale 1:1	Han 10A-gg-M20 Tüllengehäuse/ hood	
			Detail.	16.11.00	ROH.			
			Insp.		KR			
			Stand.					
413260	09.10.07	Ste	HARTING Electric GmbH & Co. KG				TB 19 20 010 1440	
28834			D-32339 Espelkamp					
Mod.	Dat.	Name	Sub.					

Blatt/ page