

A |

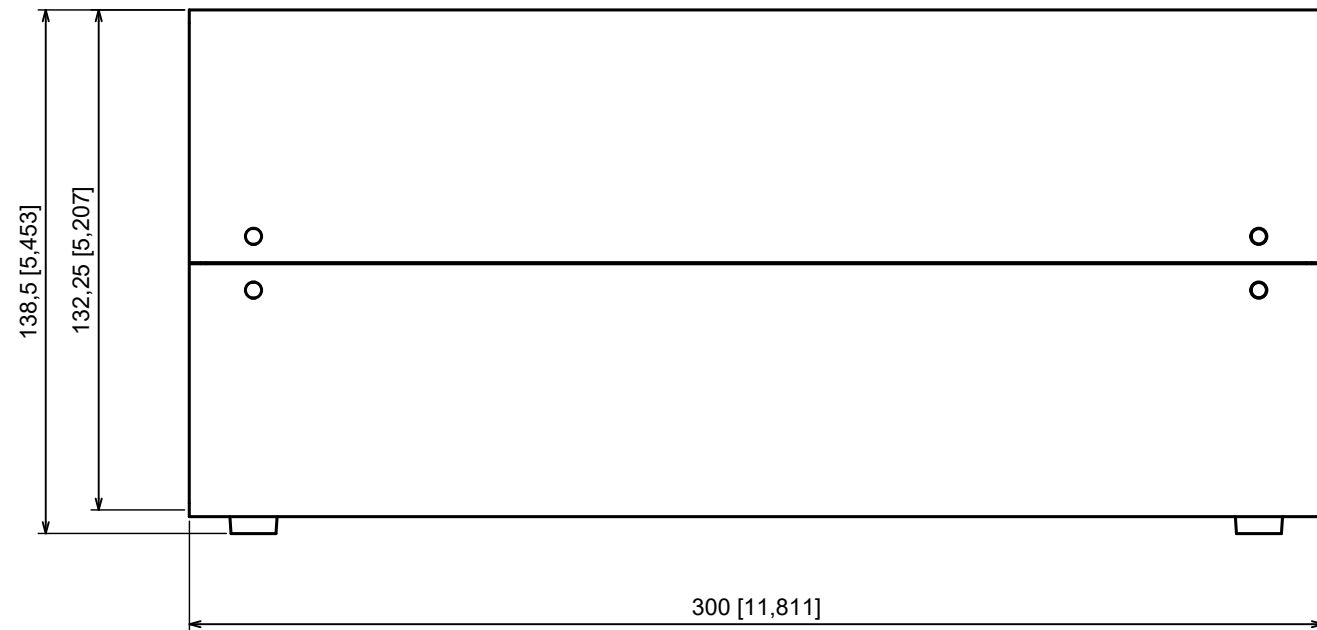

A |

A-A

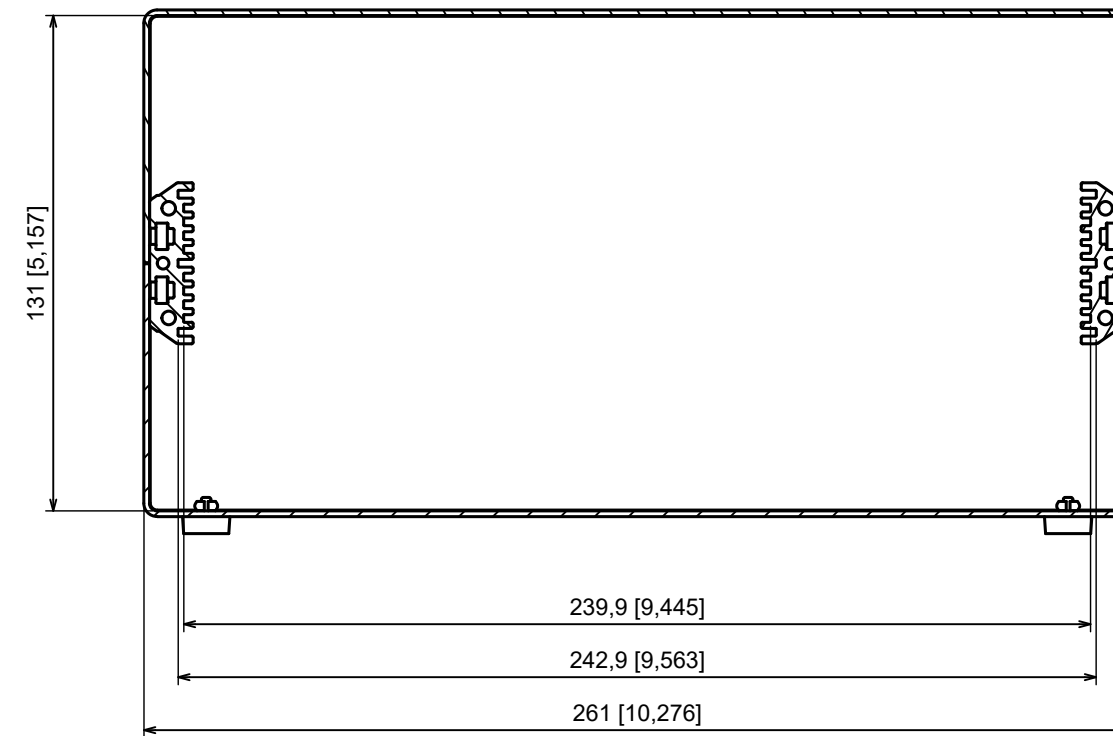

All rights reserved, Copyright Kradox 2023

Product model Enclosure ZR300.261.134 - Assembly

Format: A3 Material: Al

Scale 1:2 Tolerance: +/- 0.5



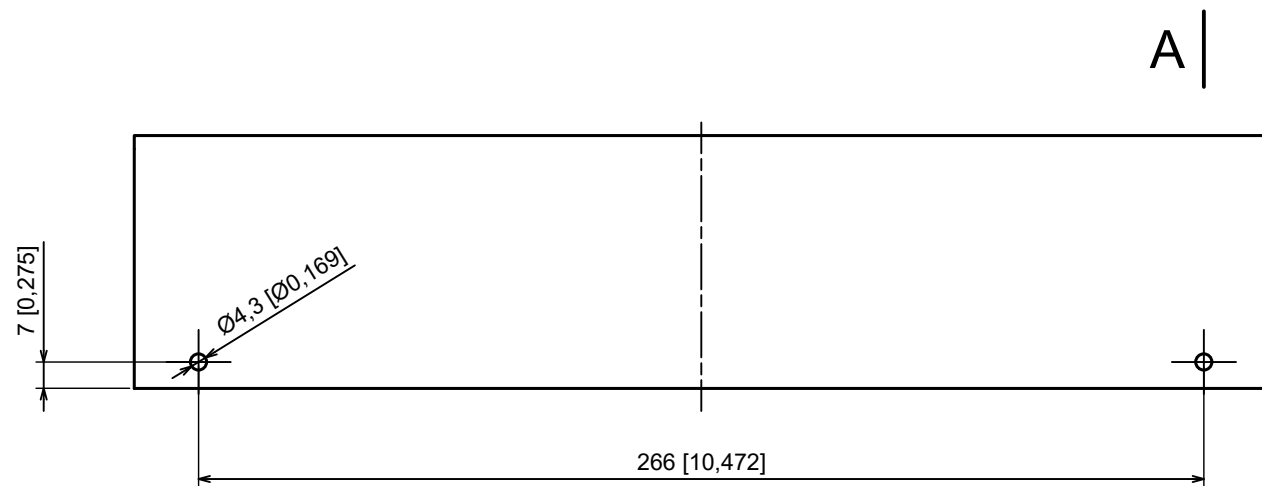
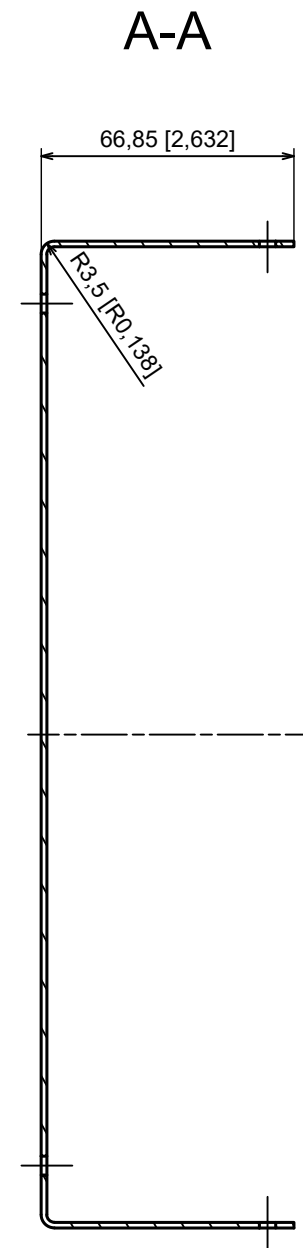
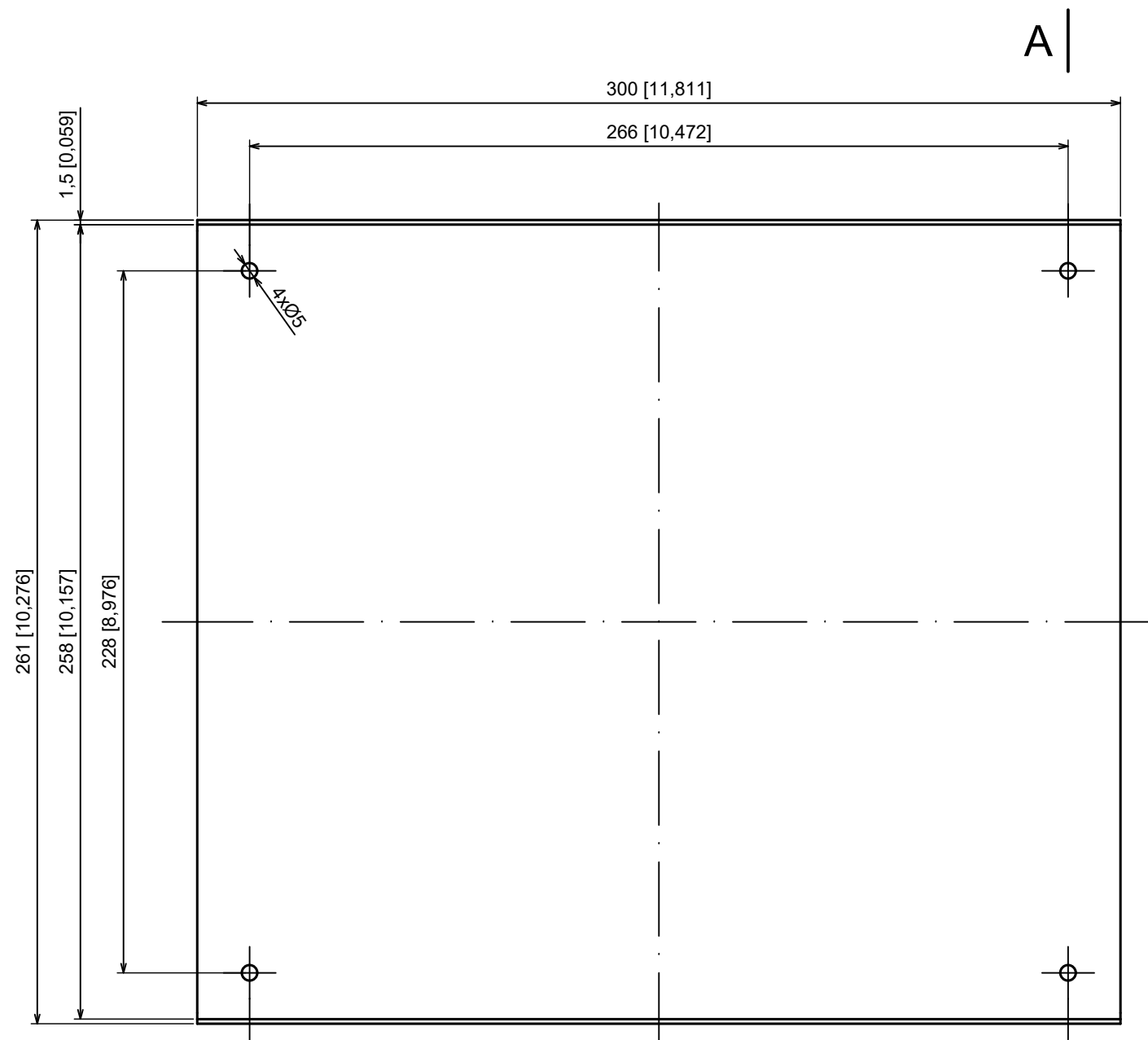

All rights reserved, Copyright Kradox 2023		
Product model	Enclosure ZR300.261.134 - Base	
Format: A3	Material: Al	
Scale 1:2	Tolerance: +/- 0.5	

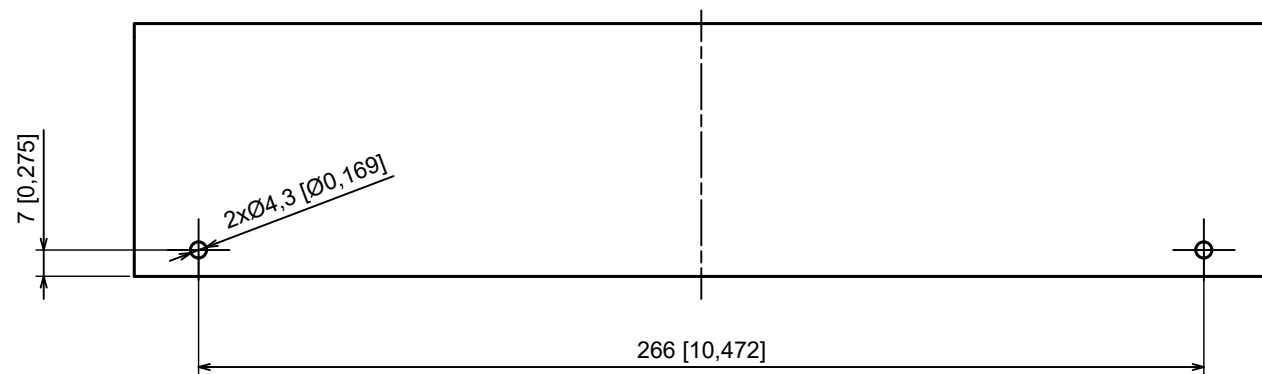
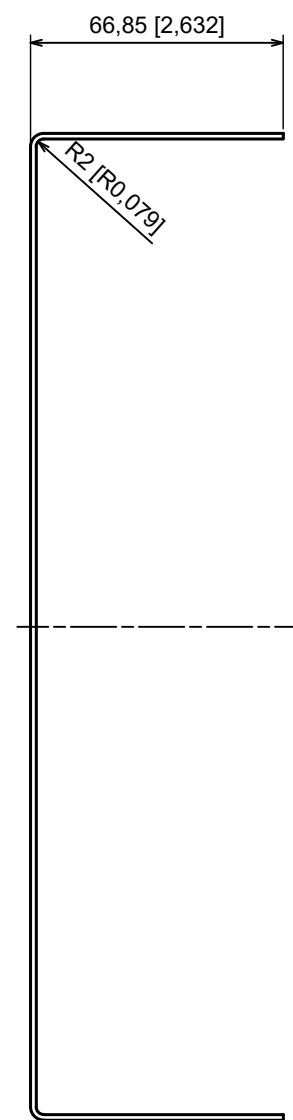
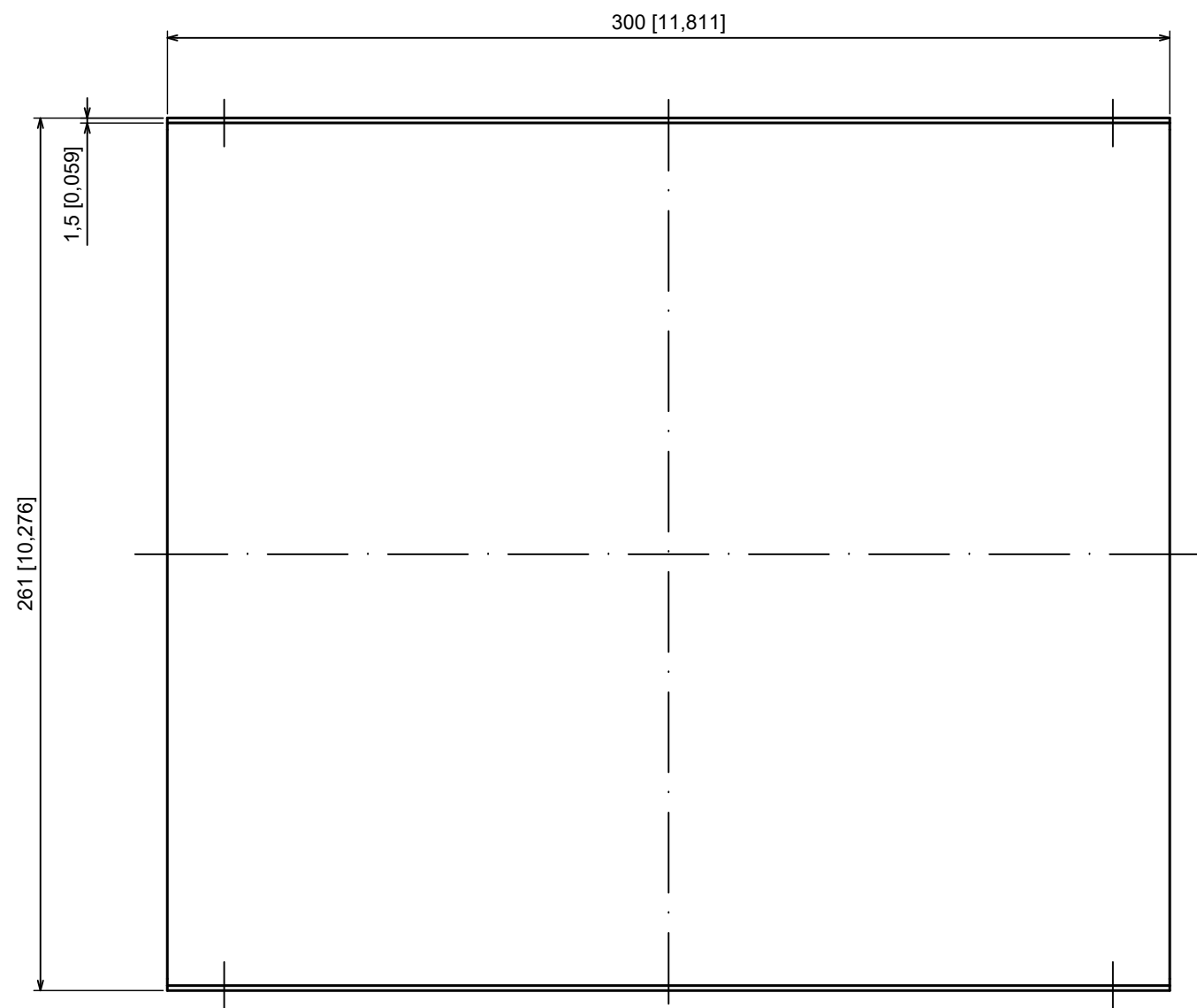

All rights reserved, Copyright Kradex 2023

Product model Enclosure ZR300.261.134 - Cover

Format: A3 Material: Al

Scale 1:2 Tolerance: +/- 0.5



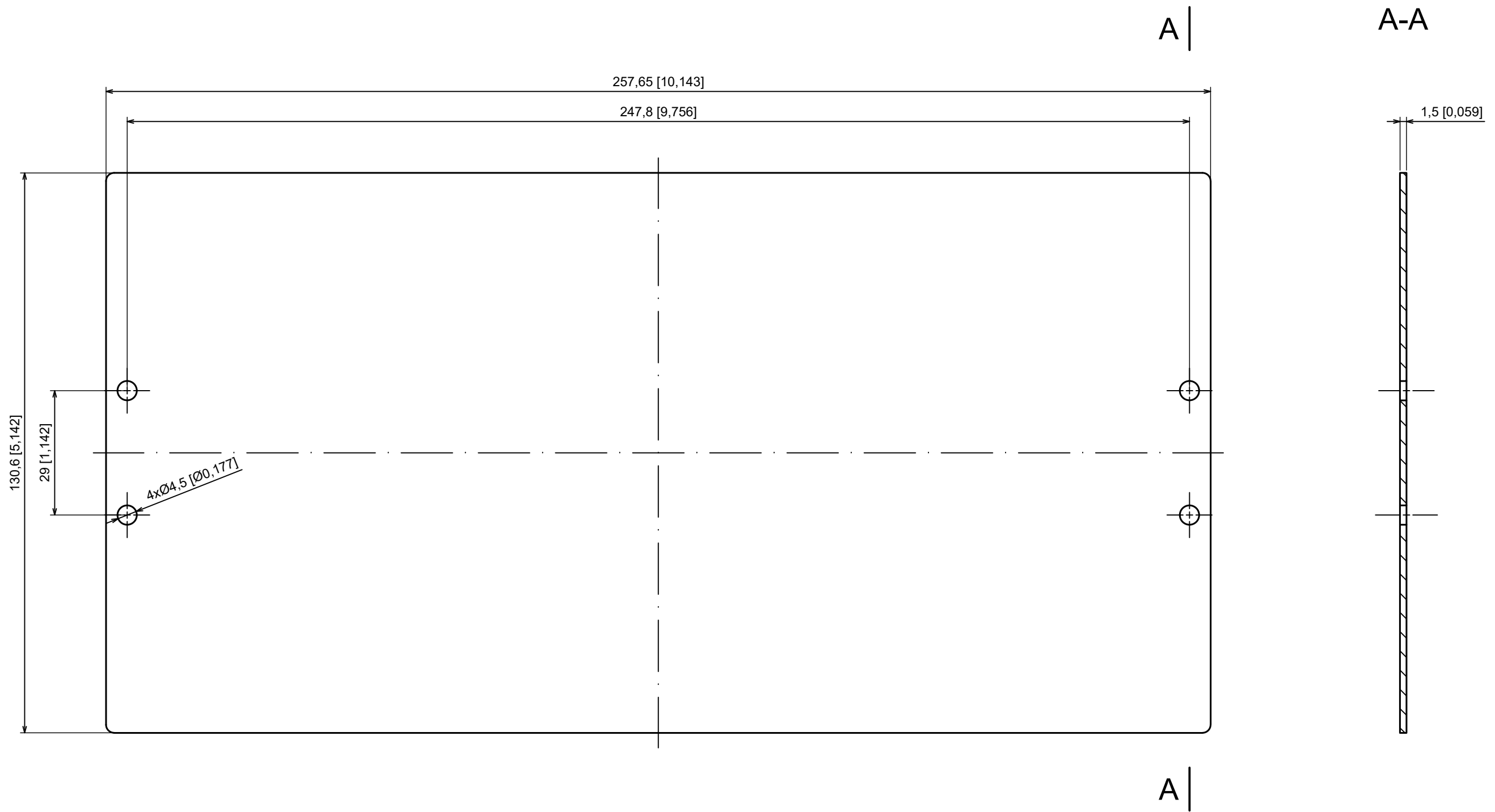

All rights reserved, Copyright Kradox 2023

Product model: Enclosure ZR300.261.134 - Front Panel

Format: A3 Material: Al

Scale 1:1 Tolerance: +/- 0.5



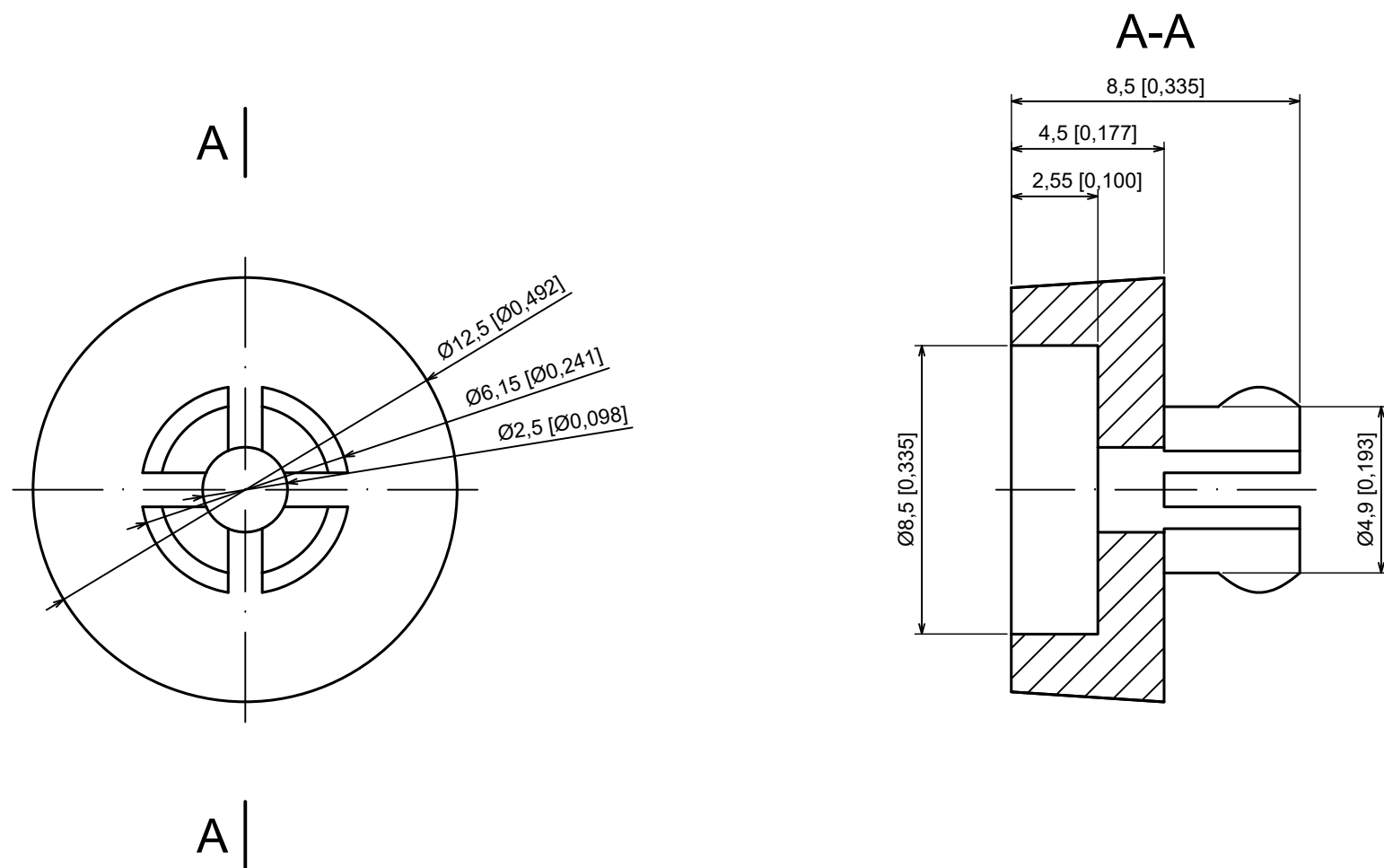

All rights reserved, Copyright Kradox 2023

Product model Enclosure ZR300.261.134 - Foot

Format: A3 Material: PE

Scale 5:1 Tolerance: +/- 0.5



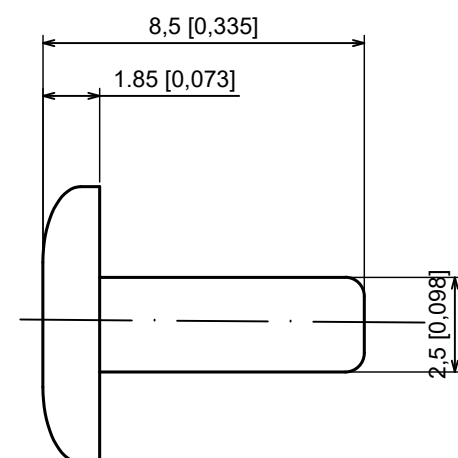
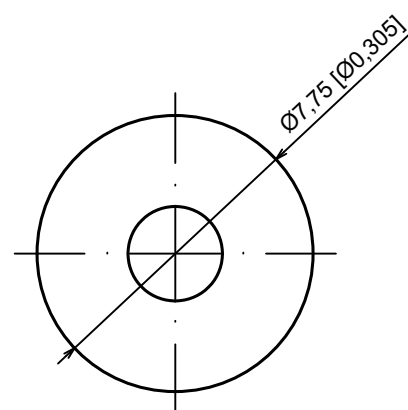

All rights reserved, Copyright Kradox 2023		
Product model	Enclosure ZR300.261.134 - Pin	
Format: A3	Material: PP	
Scale 5:1	Tolerance: +/- 0.5	

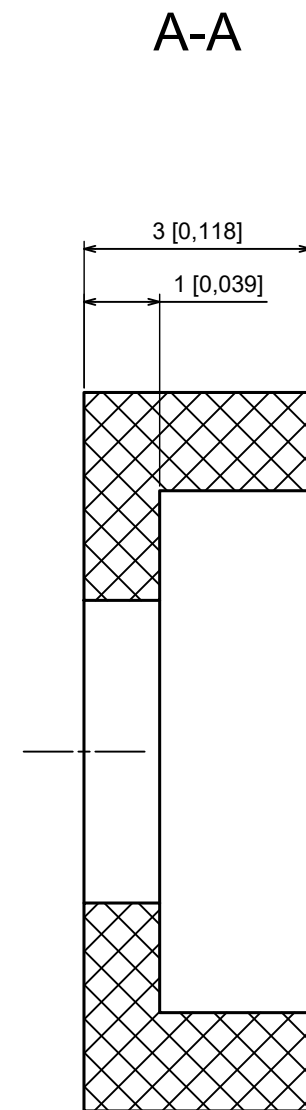
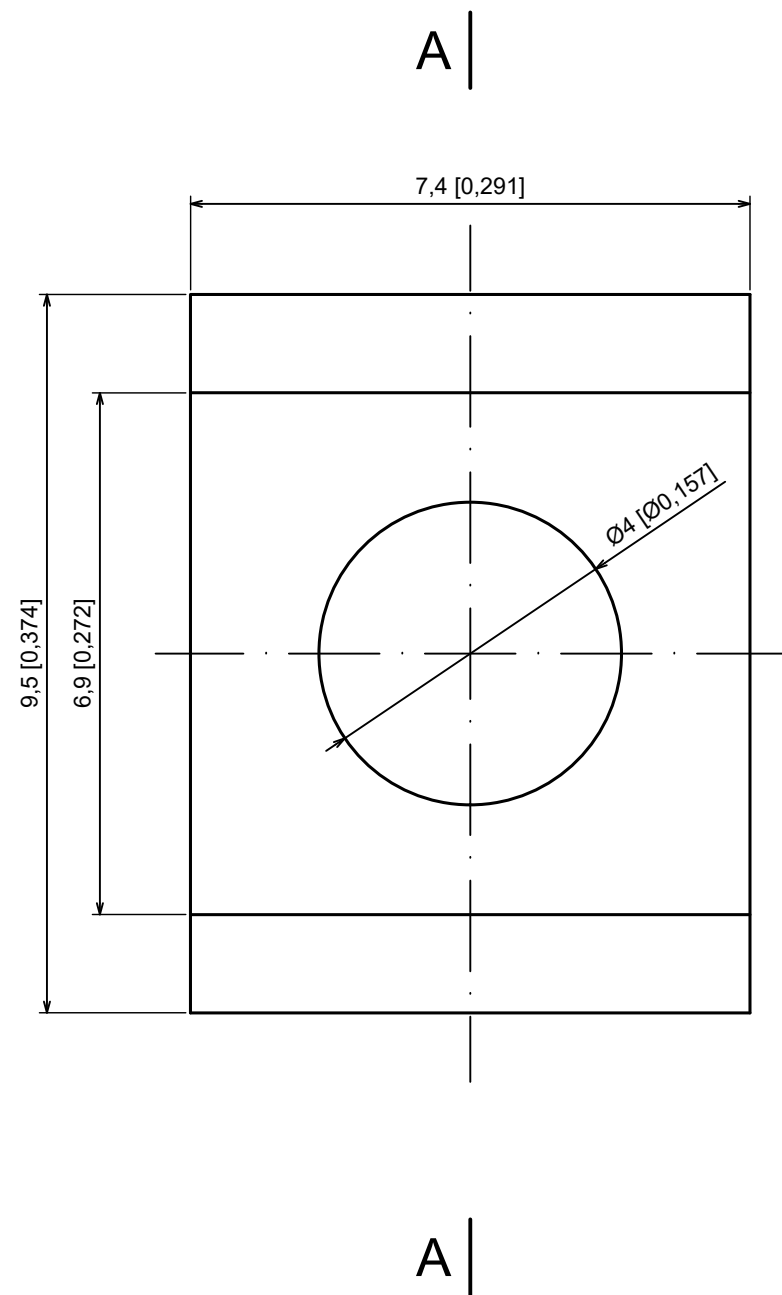

All rights reserved, Copyright Kradox 2023		
Product model	Enclosure ZR300.261.134 - Rubber Pad	
Format: A3	Material: Rubber	
Scale 10:1	Tolerance: +/- 0.5	