

GENERAL SPECIFICATIONS FOR S100s

A
Toggles

Electrical Capacity (Resistive & Inductive Load)

Power Level: Shown in the following table

Other Ratings

Contact Resistance:	10 milliohms maximum
Insulation Resistance:	200 megohms minimum @ 500V DC
Dielectric Strength:	1,500V AC minimum for 1 minute minimum
Mechanical Life:	30,000 operations minimum
Electrical Life:	10,000 operations minimum
Operating Temp Range:	-10°C through +70°C (+14°F through +158°F)

Materials & Finishes

Toggle:	Brass with chrome plating
Bushing:	Brass with chrome or nickel plating
Case:	Phenolic resin
Case Cover:	Steel with zinc plating
Movable Contactor Plate:	Copper with silver plating
Movable & Stationary Contacts:	Silver alloy plus copper with silver plating
Terminals:	Copper with silver plating

Environmental Data

Operating Temp Range: -10°C through +70°C (+14°F through +158°F)

Installation

Mounting Torque:	2.94Nm (26 lb•in) for double nut
Soldering Time & Temperature:	Manual Soldering: See Profile A in Supplement section.

Standards & Certifications

CSA: File No. 023535_0_000 - Certified only when ordered with marking on switch.
Add "/C" to end of part number to order CSA certified switch.
Certified at 5A @ 125V AC & 2A @ 250V AC.

Rockers

Pushbuttons

Illuminated PB

Programmable

Keylocks

Rotaries

Slides

Tactiles

Tilt

Touch

Indicators

Accessories

Supplement

DOUBLE POLE WITH SOLDER LUG

Model	* Approvals		Pole & Throw	Toggle Position/Connected Terminals						Electrical Capacity				Angle of Throw
	UL	CSA		Down		Center	Up		Resistive			Inductive		
				ON	2-1 5-4	NONE	OFF	—	AC 125V	AC 250V	DC 30V	AC 125V PF 0.6		
S114	—	✓	DPST	ON	2-1 5-4	NONE	OFF	—	5A	2A	5A	3A	25°	
S116	—	✓	DPDT	ON	2-1 5-4	NONE	ON	2-3 5-6	5A	2A	5A	3A	25°	
S116R	—	—	DPDT	ON	2-1 5-4	NONE	ON	2-3 5-6	5A	2A	5A	3A	25°	

Throw & Schematics:



Note: Terminal numbers are actually on the switch

Notes: Standard Hardware: AT504M Knurled Nut, AT508 Lockwasher, AT527M Backup Hex Nut. See Accessories & Hardware section.
 Optional Splashproof Boot Assemblies (only for bat lever models): AT401 & AT4181 boots plus hex nut and o-ring. See Accessories & Hardware section.

S114 & S116

S116R Black Polyamide Paddle



S116

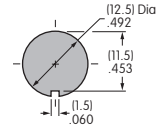
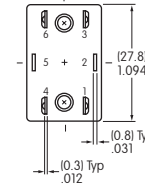
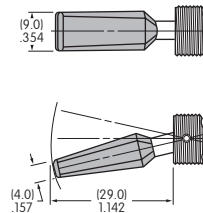
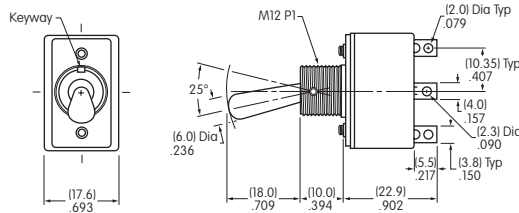

S114 does not have terminals 3 & 6

Maximum Panel Thickness: .158" (4.0mm)

Rockers

Pushbuttons

Illuminated PB

Programmable

Keylocks

Rotaries

Slides

Tactiles

Tilt

Touch

Indicators

Accessories

Supplement

GENERAL SPECIFICATIONS FOR S1 ~ S29

A
Toggles

Electrical Capacity (Resistive & Inductive Load)

Power Level: Shown in the following tables

Other Ratings

Contact Resistance: 10 milliohms maximum
Insulation Resistance: 1,000 megohms minimum @ 500V DC
Dielectric Strength: 2,000V AC minimum for 1 minute minimum
Mechanical Life: 30,000 operations minimum for S5AW, S8AW, S9AW, S25AW, S28AW, S29AW
 50,000 operations minimum for all other models
Electrical Life: 25,000 operations minimum
Angle of Throw (α): Shown in tables on following pages

Materials & Finishes

Toggle: Brass with chrome plating
Bushing: Brass with chrome plating
Case: Phenolic resin
Case Cover: Steel with zinc plating
Movable Contactor: Copper with silver plating
Movable Contacts: Silver alloy capped on copper with silver plating
Stationary Contacts: Silver alloy capped on copper with silver plating
Terminals: Brass with tin plating

Environmental Data

Operating Temp Range: -30°C through +70°C (-22°F through +158°F) for Splashproof models;
 -10°C through +70°C (+14°F through +158°F) for all other models
Sealing: Splashproof & lever lock panel seal models meet IP67 standard

Installation

Mounting Torque: 1.47Nm (13 lb•in) for single nut on AW & AL models
 2.94Nm (26 lb•in) for double nut on other models
Maximum Panel Thickness: Shown beneath panel cutout in switch dimension drawings
Soldering Time & Temperature: Manual Soldering: See Profile A in Supplement section.

Standards & Certifications

UL: **File No. E44145 - Recognized only when ordered with marking on switch.**
 Add "/U" or "/CUL" to end of part number to order UL recognized switch.
 UL or cULus recognition designated beside part numbers on following pages.
 See Supplement section to find UL or cULus rating details.

CSA: **File No. 023535_0_000 - Certified only when ordered with marking on switch.**
 Add "/C" to end of part number to order CSA certified switch.
 CSA certification designated beside part numbers on following pages.
 See Supplement section to find CSA rating details.

Rockers

Pushbuttons

Illuminated PB

Programmable

Keylocks

Rotaries

Slides

Tactiles

Tilt

Touch

Indicators

Accessories

Supplement

Toggles **A**

SINGLE POLE WITH SOLDER LUG

* UL, cULus & CSA recognized only when ordered with marking on switch (see General Specs)				Toggle Position/Connected Terminals					Electrical Capacity			
Model	* Approvals			Pole & Throw	Down	Center	Up	Resistive			Inductive	Angle of Throw
	UL	cULus	CSA		Keyway			AC 125V	AC 250V	DC 30V	AC 125V PF 0.6	
S1A	✓	✓	✓	SPST	ON 1-3	NONE	OFF —	15A	6A	20A	8A	25°
S2A	✓	✓	✓	SPDT	ON 2-3	NONE	ON 2-1	15A	6A	20A	8A	25°
S3A	✓	✓	✓	SPDT	ON 2-3	OFF	ON 2-1	15A	6A	20A	8A	25°

Throw & Schematics: SPST INTERNAL CONNECTION SPDT

Note: Terminal numbers are actually on the switch

Notes: Standard Hardware: AT504M Knurled Nut, AT508 Lockwasher, AT527M Backup Hex Nut. See Accessories & Hardware section.
Optional Splashproof Boot Assemblies: AT401 & AT4181 boots plus hex nut & o-ring. See Accessories & Hardware section.

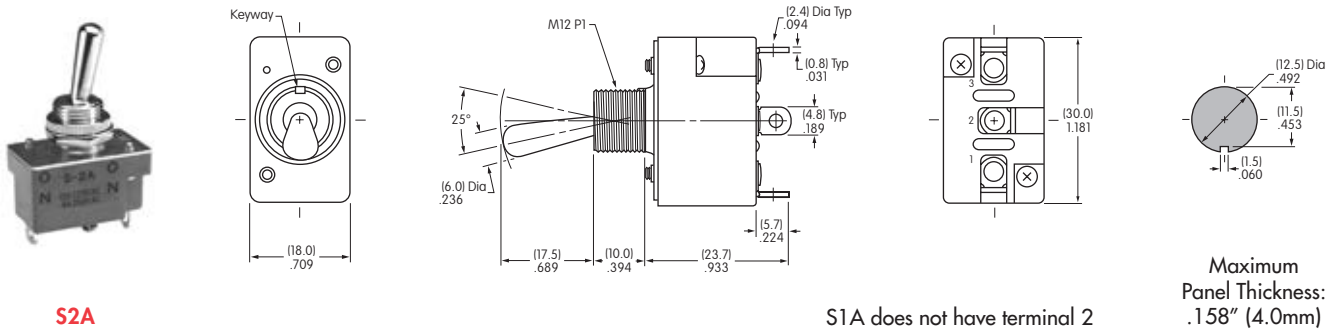

S2A

S1A does not have terminal 2

Maximum Panel Thickness: .158" (4.0mm)

DOUBLE POLE WITH SOLDER LUG

* UL, cULus & CSA recognized only when ordered with marking on switch (see General Specs)				Toggle Position/Connected Terminals					Electrical Capacity			
Model	* Approvals			Pole & Throw	Down	Center	Up	Resistive			Inductive	α = Angle of Throw
	UL	cULus	CSA		Keyway			AC 125V	AC 250V	DC 30V	AC 125V PF 0.6	
S21A	—	—	—	DPST	ON 1-3 4-6	NONE	OFF —	15A	15A	15A	8A	21°
S6A	✓	✓	✓	DPDT	ON 2-3 5-6	NONE	ON 2-1 5-4	20A	10A	20A	8A	21°
S7A	—	—	✓	DPDT	ON 2-3 5-6	OFF	ON 2-1 5-4	20A	10A	20A	8A	28°

Throw & Schematics: DPST INTERNAL CONNECTION DPDT

Note: Terminal numbers are actually on the switch

Notes: Standard Hardware: AT504M Knurled Nut, AT508 Lockwasher, AT527M Backup Hex Nut. See Accessories & Hardware section.
Optional Splashproof Boot Assemblies: AT401 & AT4181 boots plus hex nut & o-ring. See Accessories & Hardware section.

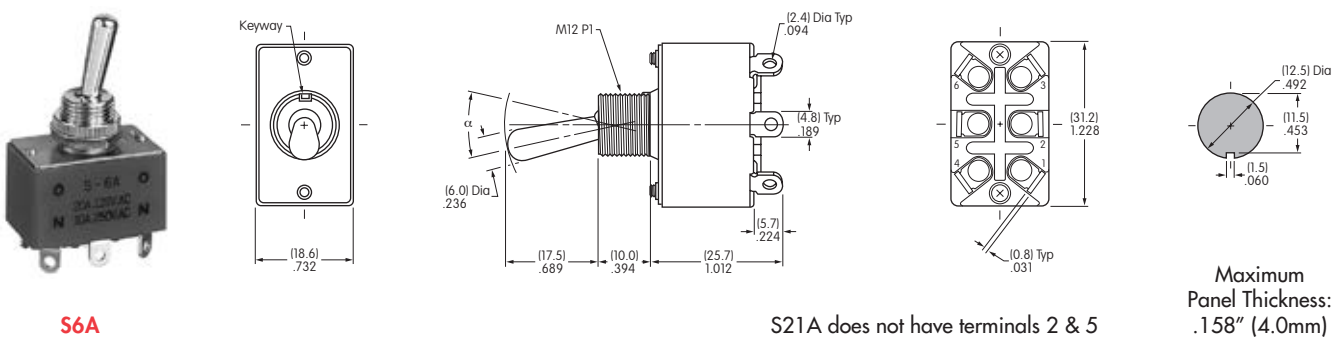

S6A

S21A does not have terminals 2 & 5

Maximum Panel Thickness: .158" (4.0mm)

Toggles
Rockers
Pushbuttons
Illuminated PB
Programmable
Keylocks
Rotaries
Slides
Tactiles
Tilt
Touch
Indicators
Accessories
Supplement

SINGLE POLE WITH QUICK CONNECT

Model	Approvals		Pole & Throw	Toggle Position/Connected Terminals				Electrical Capacity				Angle of Throw
	UL	SP		Down 	Center 	Up 	Resistive			Inductive		
							AC 125V	AC 250V	DC 30V	AC 125V PF 0.6		
S1F	—	—	SPST	ON 1-3	NONE	OFF —	15A	6A	20A	8A	25°	
S2F	—	—	SPDT	ON 2-3	NONE	ON 2-1	15A	6A	20A	8A	25°	
S3F	—	—	SPDT	ON 2-3	OFF	ON 2-1	15A	6A	20A	8A	25°	

Throw & Schematics: SPST INTERNAL CONNECTION SPDT

Note: Terminal numbers are actually on the switch

Notes: Standard Hardware: AT504M Knurled Nut, AT508 Lockwasher, AT527M Backup Hex Nut. See Accessories & Hardware section.
Optional Splashproof Boot Assemblies: AT401 & AT4181 boots plus hex nut & o-ring. See Accessories & Hardware section.

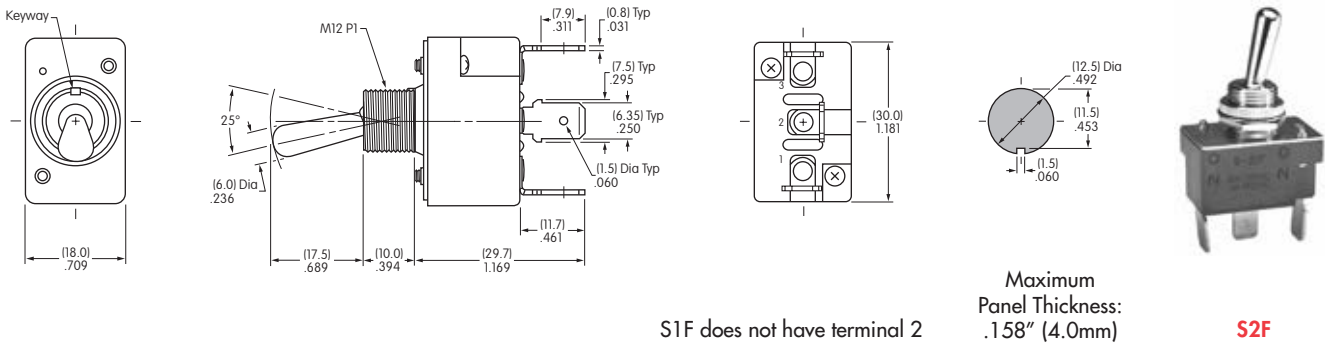

DOUBLE POLE WITH QUICK CONNECT

Model	Approvals		Pole & Throw	Toggle Position/Connected Terminals				Electrical Capacity				$\alpha =$ Angle of Throw
	UL	SP		Down 	Center 	Up 	Resistive			Inductive		
							AC 125V	AC 250V	DC 30V	AC 125V PF 0.6		
S21F	—	—	DPST	ON 1-3 4-6	NONE	OFF —	15A	15A	15A	8A	21°	
S6F	—	—	DPDT	ON 2-3 5-6	NONE	ON 2-1 5-4	20A	10A	20A	8A	21°	
S7F	—	—	DPDT	ON 2-3 5-6	OFF	ON 2-1 5-4	20A	10A	20A	8A	28°	



Throw & Schematics: DPST INTERNAL CONNECTION DPDT

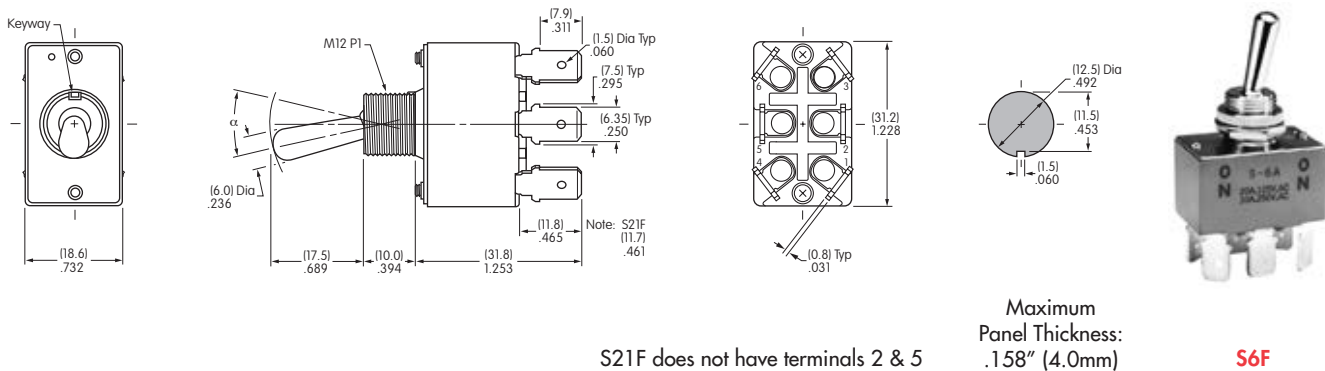

Note: Terminal numbers are actually on the switch

Notes: Standard Hardware: AT504M Knurled Nut, AT508 Lockwasher, AT527M Backup Hex Nut. See Accessories & Hardware section.
Optional Splashproof Boot Assemblies: AT401 & AT4181 boots plus hex nut & o-ring. See Accessories & Hardware section.



SINGLE POLE SOLDER LUG WITH PANEL SEAL

Model	Approvals UL SF	Pole & Throw	Toggle Position/Connected Terminals () = Momentary				Electrical Capacity			α = Angle of Throw
			Down 	Center 	Up 	Resistive				
			AC 125V	AC 250V	DC 30V					
S1AW	—	SPST	ON 1-3	NONE	OFF —	15A	6A	20A	24°	
S2AW	—	SPDT	ON 2-3	NONE	ON 2-1	15A	6A	20A	24°	
S3AW	—	SPDT	ON 2-3	OFF	ON 2-1	15A	6A	20A	28°	
S5AW	—	SPDT	ON 2-3	NONE	(ON) 2-1	15A	6A	20A	20°	
S8AW	—	SPDT	(ON) 2-3	OFF	(ON) 2-1	15A	6A	20A	24°	
S9AW	—	SPDT	ON 2-3	OFF	(ON) 2-1	15A	6A	20A	24°	

Throw & Schematics: SPST  INTERNAL CONNECTION  Note: Terminal numbers are actually on the switch

Notes: Standard Hardware: AT503M Face Hex Nut, Lockwasher, AT537 O-ring. See Accessories & Hardware section. For .250" Quick Connect terminals, add "F" to end of part number. See Quick Connect terminal dimensions on previous page. For further information, contact factory.



S2AW

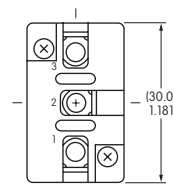
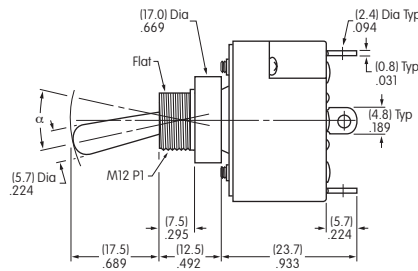
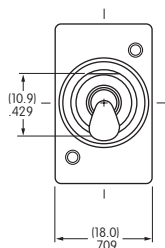



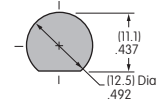

S1AW does not have terminal 2



Maximum Panel Thickness: .158" (4.0mm)

DOUBLE POLE SOLDER LUG WITH PANEL SEAL

Model	Approvals UL SF	Pole & Throw	Toggle Position/Connected Terminals () = Momentary				Electrical Capacity			α = Angle of Throw
			Down 	Center 	Up 	Resistive				
			AC 125V	AC 250V	DC 30V					
S21AW	—	DPST	ON 1-3 4-6	NONE	OFF —	15A	15A	15A	22°	
S6AW	—	DPDT	ON 2-3 5-6	NONE	ON 2-1 5-4	20A	10A	20A	22°	
S7AW	—	DPDT	ON 2-3 5-6	OFF	ON 2-1 5-4	20A	10A	20A	28°	
S25AW	—	DPDT	ON 2-3 5-6	NONE	(ON) 2-1 5-4	15A	6A	20A	20°	
S28AW	—	DPDT	(ON) 2-3 5-6	OFF	(ON) 2-1 5-4	15A	6A	20A	22°	
S29AW	—	DPDT	ON 2-3 5-6	OFF	(ON) 2-1 5-4	15A	6A	20A	22°	

Throw & Schematics: DPST  INTERNAL CONNECTION  Note: Terminal numbers are actually on the switch

Notes: Standard Hardware: AT503M Face Hex Nut, Lockwasher, AT537 O-ring. See Accessories & Hardware section. For .250" Quick Connect terminals, add "F" to end of part number. See Quick Connect terminal dimensions on previous page. For further information, contact factory.



S6AW

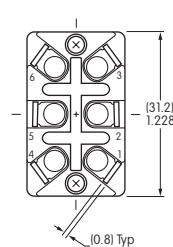
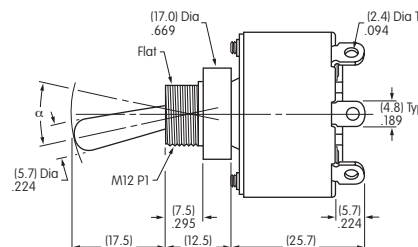
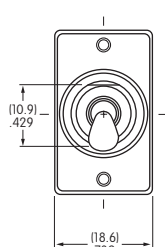

S21AW does not have terminals 2 & 5

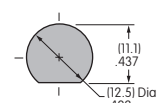

Maximum Panel Thickness: .158" (4.0mm)

SINGLE POLE SOLDER LUG WITH LOCKING LEVER & PANEL SEAL

Model	Approvals		Pole & Throw	Toggle Position/Connected Terminals				Electrical Capacity				$\alpha =$ Angle of Throw
	UL	cULus		Down Keyway	Center	Up	Resistive			Inductive AC 125V PF 0.6		
							AC 125V	AC 250V	DC 30V			
S1AL	—	—	SPST	ON 1-3	NONE	OFF —	15A	6A	20A	8A	24°	
S2AL	—	—	SPDT	ON 2-3	NONE	ON 2-1	15A	6A	20A	8A	24°	
S3AL	—	—	SPDT	ON 2-3	OFF	ON 2-1	15A	6A	20A	8A	28°	

Throw & Schematics:

SPST: INTERNAL CONNECTION

SPDT: 2 (COM)

Note: Terminal numbers are actually on the switch

Notes: Standard Hardware: AT503M Face Hex Nut, Lockwasher, AT537 O-ring. See Accessories & Hardware section.

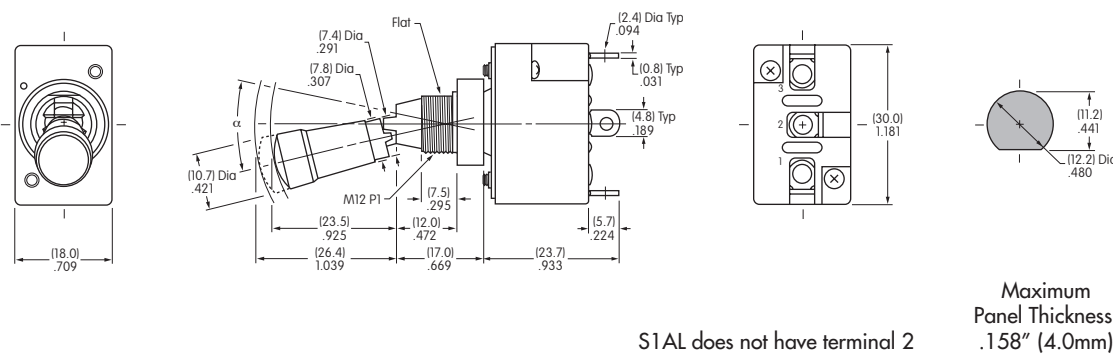

DOUBLE POLE SOLDER LUG WITH LOCKING LEVER & PANEL SEAL

* UL & cULus recognized only when ordered with marking on switch (see General Specs)

Model	Approvals		Pole & Throw	Toggle Position/Connected Terminals				Electrical Capacity				$\alpha =$ Angle of Throw
	UL	cULus		Down Keyway	Center	Up	Resistive			Inductive AC 125V PF 0.6		
							AC 125V	AC 250V	DC 30V			
S21AL	—	—	DPST	ON 1-3 4-6	NONE	OFF —	15A	15A	15A	8A	22°	
S6AL	✓	✓	DPDT	ON 2-3 5-6	NONE	ON 2-1 5-4	20A	10A	20A	8A	22°	
S7AL	—	—	DPDT	ON 2-3 5-6	OFF	ON 2-1 5-4	20A	10A	20A	8A	28°	

Throw & Schematics:

DPST: INTERNAL CONNECTION

DPDT: 2 (COM)

Note: Terminal numbers are actually on the switch

Notes: Standard Hardware: AT503M Face Hex Nut, Lockwasher, AT537 O-ring. See Accessories & Hardware section.

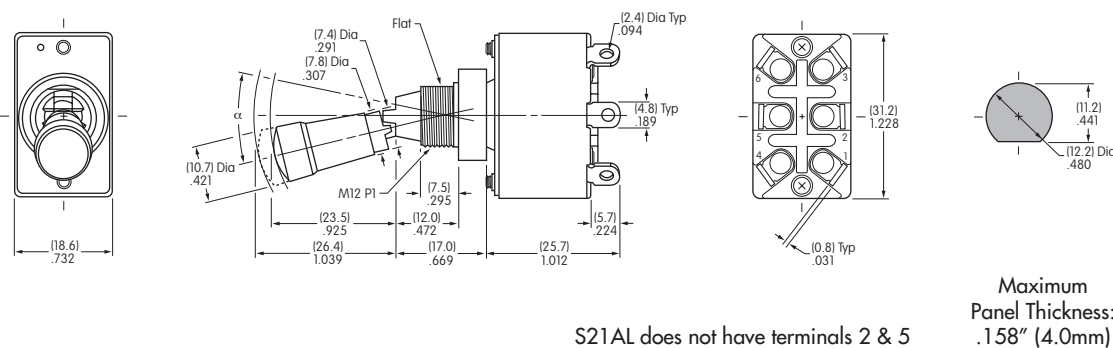

GENERAL SPECIFICATIONS FOR S301 ~ S339

Toggles
A

Rockers

Pushbuttons

Illuminated PB

Programmable

Keylocks

Rotaries

Slides

Tactiles

Tilt

Touch

Indicators

Accessories

Supplement

Electrical Capacity (Resistive & Inductive Load)

Power Level: Shown in the following tables

Other Ratings

Contact Resistance:	10 milliohms maximum
Insulation Resistance:	1,000 megohms minimum @ 500V DC
Dielectric Strength:	2,000V AC minimum for 1 minute minimum
Mechanical Life:	50,000 operations minimum
Electrical Life:	6,000 operations minimum for S331F; 15,000 operations minimum for all other S331s; 25,000 operations minimum for all others
Angle of Throw (α):	Shown on following tables

Materials & Finishes

Toggle:	PBT for flatted lever; brass with chrome plating for all others
Bushing:	Brass with chrome plating
Case:	Melamine phenol
Case Cover:	Steel with zinc plating
Movable Contactor:	Copper with silver plating
Movable & Stationary Contacts:	Silver alloy capped on copper with silver plating
Terminals:	Brass with tin plating

Environmental Data

Operating Temperature Range: $-10^{\circ}\text{C} \sim +70^{\circ}\text{C}$ ($+14^{\circ}\text{F} \sim +158^{\circ}\text{F}$)

Installation

Mounting Torque: 2.94Nm (26 lb•in) for double nut; 1.47Nm (13 lb•in) for single nut
Soldering Time & Temperature: Manual Soldering: See Profile A in Supplement section.

Standards & Certifications

UL: **File No. E44145 - Recognized only when ordered with marking on switch.**
 Add "/U" or "/CUL" to end of part number to order UL recognized switch.
 UL or cULus recognition designated beside part numbers on following pages.
 See Supplement section to find UL or cULus rating details.

CSA: **File No. 023535_0_000 - Certified only when ordered with marking on switch.**
 Add "/C" to end of part number to order CSA certified switch.
 CSA certification designated beside part numbers on following pages.
 See Supplement section to find CSA rating details

SINGLE POLE WITH SOLDER LUG

* UL, cULus & CSA recognized only when ordered with marking on switch (see General Specs)			Toggle Position/Connected Terminals () = Momentary						Electrical Capacity			
Model	* Approvals			Pole & Throw	Down Keyway	Center	Up	Resistive			Inductive AC 125V PF 0.6	Angle of Throw
	UL	cULus	CSA					AC 125V	AC 250V	DC 30V		
S301	✓	✓	✓	SPST	ON 1-3	NONE	OFF —	15A	6A	20A	10A	32°
S302	✓	✓	✓	SPDT	ON 2-3	NONE	ON 2-1	15A	6A	20A	10A	32°
S303	✓	✓	✓	SPDT	ON 2-3	OFF	ON 2-1	15A	6A	20A	10A	32°
S305	—	—	✓	SPDT	ON 2-3	NONE	(ON) 2-1	15A	6A	20A	8A	32°
S308	—	—	✓	SPDT	(ON) 2-3	OFF	(ON) 2-1	15A	6A	20A	8A	32°
S309	—	—	✓	SPDT	ON 2-3	OFF	(ON) 2-1	15A	6A	20A	8A	32°

Throw & Schematics: SPST INTERNAL CONNECTION Note: Terminal numbers are actually on the switch

Notes: Standard Hardware: AT503M Face Hex Nut, AT506M Locking Ring, AT508 Lockwasher, AT527M Backup Hex Nut. See Accessories & Hardware section.
Optional Splashproof Boot Assemblies: AT401 & AT4181 boots plus hex nut & o-ring. See Accessories & Hardware section.

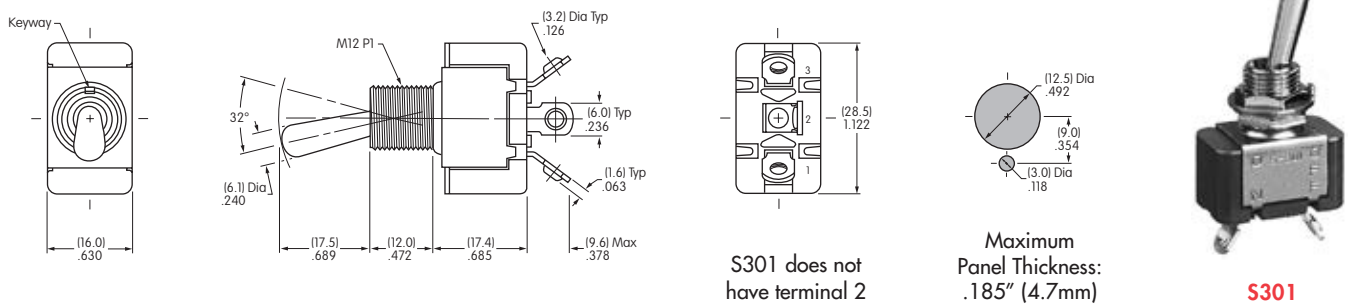

DOUBLE POLE WITH SOLDER LUG

* UL, cULus & CSA recognized only when ordered with marking on switch (see General Specs)			Toggle Position/Connected Terminals () = Momentary						Electrical Capacity			
Model	* Approvals			Pole & Throw	Down Keyway	Center	Up	Resistive			Inductive AC 125V PF 0.6	α = Angle of Throw
	UL	cULus	CSA					AC 125V	AC 250V	DC 30V		
S331	✓	✓	✓	DPST	ON 1-3 4-6	NONE	OFF —	20A	20A	20A	10A	25°
S332	✓	✓	✓	DPDT	ON 2-3 5-6	NONE	ON 2-1 5-4	20A	15A	20A	10A	25°
S333	✓	✓	✓	DPDT	ON 2-3 5-6	OFF	ON 2-1 5-4	20A	15A	20A	10A	30°
S335	✓	✓	✓	DPDT	ON 2-3 5-6	NONE	(ON) 2-1 5-4	15A	6A	20A	8A	25°
S338	✓	✓	—	DPDT	(ON) 2-3 5-6	OFF	(ON) 2-1 5-4	15A	6A	20A	8A	25°
S339	✓	✓	—	DPDT	ON 2-3 5-6	OFF	(ON) 2-1 5-4	15A	6A	20A	8A	25°

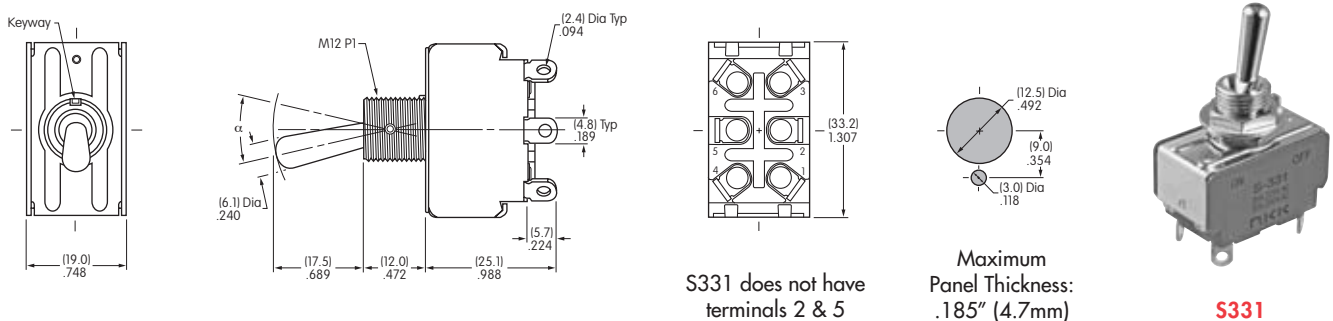

Throw & Schematics: DPST INTERNAL CONNECTION Note: Terminal numbers are actually on the switch

Notes: Standard Hardware: AT503M Face Hex Nut, AT506M Locking Ring, AT508 Lockwasher, AT527M Backup Hex Nut. See Accessories & Hardware section.
Optional Splashproof Boot Assemblies: AT401 & AT4181 boots plus hex nut & o-ring. See Accessories & Hardware section.



A Toggles
 Rockers
 Pushbuttons
 Illuminated PB
 Programmable
 Keylocks
 Rotaries
 Slides
 Tactiles
 Tilt
 Touch
 Indicators
 Accessories
 Supplement

DOUBLE POLE WITH SOLDER LUG & FLATTED LEVER

Model	* Approvals			Pole & Throw	Toggle Position/Connected Terminals () = Momentary						Electrical Capacity				α = Angle of Throw
	UL	cULus	CS		Down 	Center 	Up 	Resistive			Inductive				
								AC 125V	AC 250V	DC 30V	AC 125V PF 0.6				
S331R	✓	✓	—	DPST	ON 1-3 4-6	NONE	OFF —	20A	20A	20A	10A	25°			
S332R	✓	✓	—	DPDT	ON 2-3 5-6	NONE	ON 2-1 5-4	20A	15A	20A	10A	25°			
S333R	✓	✓	—	DPDT	ON 2-3 5-6	OFF	ON 2-1 5-4	20A	15A	20A	10A	30°			
S338R	✓	✓	—	DPDT	(ON) 2-3 5-6	OFF	(ON) 2-1 5-4	15A	6A	20A	8A	25°			
S339R	✓	✓	—	DPDT	ON 2-3 5-6	OFF	(ON) 2-1 5-4	15A	6A	20A	8A	25°			



Note: Terminal numbers are actually on the switch

Notes: Standard Hardware: AT504M Knurled Nut, AT508 Lockwasher, AT527M Backup Hex Nut. See Accessories & Hardware section.



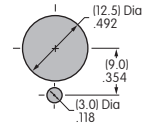
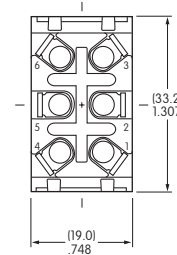
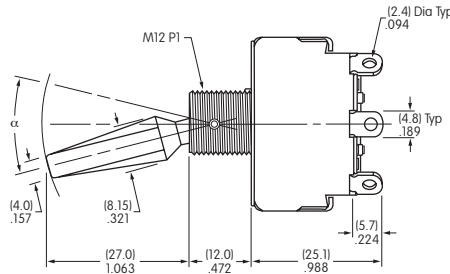
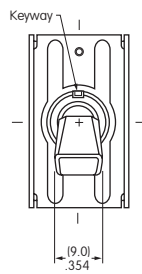

S331R





S331R does not have terminals 2 & 5

Maximum Panel Thickness: .220" (5.6mm)

SINGLE POLE WITH SCREW LUG



* UL, cULus & CSA recognized only when ordered with marking on switch (see General Specs)			Toggle Position/Connected Terminals () = Momentary					Electrical Capacity				$\alpha =$ Angle of Throw
Model	* Approvals			Pole & Throw	Down 	Center 	Up 	Resistive			Inductive	
	UL	cULus	CSA					AC 125V	AC 250V	DC 30V	AC 125V PF 0.6	
S301T	✓	✓	✓	SPST	ON 1-3	NONE	OFF —	15A	6A	20A	10A	32°
S302T	✓	✓	✓	SPDT	ON 2-3	NONE	ON 2-1	15A	6A	20A	10A	32°
S303T	✓	✓	✓	SPDT	ON 2-3	OFF	ON 2-1	15A	6A	20A	10A	32°
S305T	—	—	✓	SPDT	ON 2-3	NONE	(ON) 2-1	15A	6A	20A	8A	32°
S308T	—	—	✓	SPDT	(ON) 2-3	OFF	(ON) 2-1	15A	6A	20A	8A	32°
S309T	—	—	✓	SPDT	ON 2-3	OFF	(ON) 2-1	15A	6A	20A	8A	32°

Throw & Schematics: SPST  INTERNAL CONNECTION  Note: Terminal numbers are actually on the switch

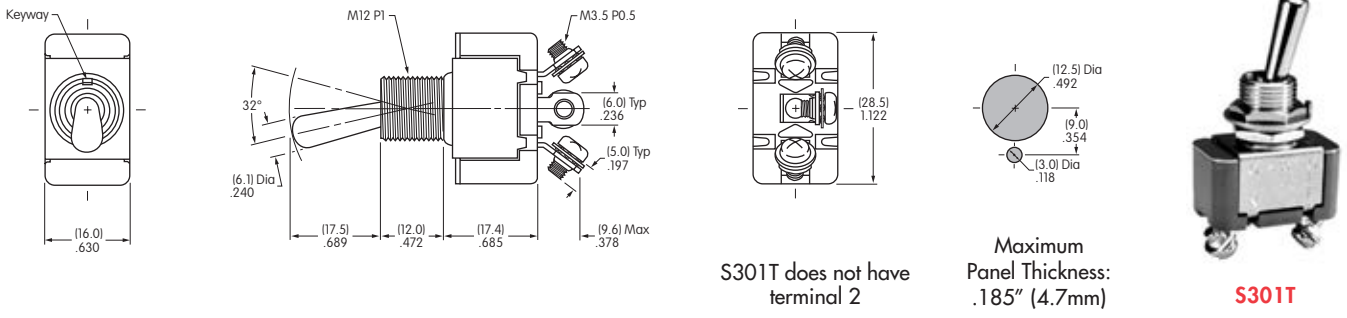
Notes: Standard Hardware: AT503M Face Hex Nut, AT506M Locking Ring, AT508 Lockwasher, AT527M Backup Hex Nut. See Accessories & Hardware section. Optional Splashproof Boot Assemblies: AT401 & AT4181 boots plus hex nut & o-ring. See Accessories & Hardware section.



DOUBLE POLE WITH SCREW LUG

* UL & cULus recognized only when ordered with marking on switch (see General Specs)			Toggle Position/Connected Terminals () = Momentary					Electrical Capacity				$\alpha =$ Angle of Throw
Model	* Approvals			Pole & Throw	Down 	Center 	Up 	Resistive			Inductive	
	UL	cULus	CSA					AC 125V	AC 250V	DC 30V	AC 125V PF 0.6	
S331T	✓	✓	—	DPST	ON 1-3 4-6	NONE	OFF —	15A	15A	15A	10A	25°
S332T	✓	✓	—	DPDT	ON 2-3 5-6	NONE	ON 2-1 5-4	15A	15A	15A	10A	25°
S333T	✓	✓	—	DPDT	ON 2-3 5-6	OFF	ON 2-1 5-4	15A	15A	15A	10A	30°
S335T	✓	✓	—	DPDT	ON 2-3 5-6	NONE	(ON) 2-1 5-4	15A	6A	20A	8A	25°
S338T	✓	✓	—	DPDT	(ON) 2-3 5-6	OFF	(ON) 2-1 5-4	15A	6A	20A	8A	25°
S339T	✓	✓	—	DPDT	ON 2-3 5-6	OFF	(ON) 2-1 5-4	15A	6A	20A	8A	25°

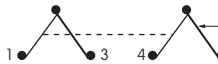
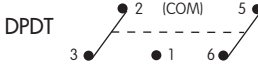
Throw & Schematics: DPST  INTERNAL CONNECTION  Note: Terminal numbers are actually on the switch

Notes: Standard Hardware: AT503M Face Hex Nut, AT506M Locking Ring, AT508 Lockwasher, AT527M Backup Hex Nut. See Accessories & Hardware section. Optional Splashproof Boot Assemblies: AT401 & AT4181 boots plus hex nut & o-ring. See Accessories & Hardware section.

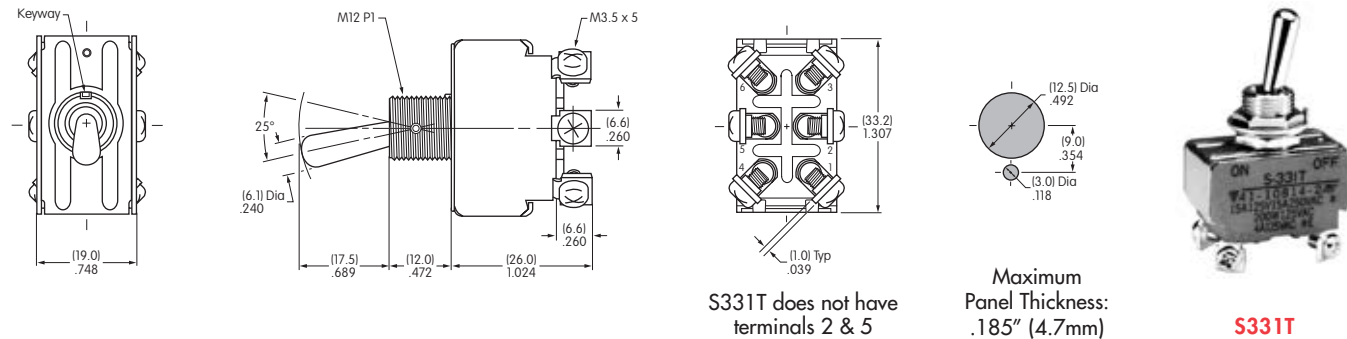

Toggles **A**

Rockers

Pushbuttons

Illuminated PB

Programmable PB

Keylocks

Rotaries

Slides

Tactiles

Tilt

Touch

Indicators

Accessories

Supplement

SINGLE POLE WITH QUICK CONNECT

* UL, cULus & CSA recognized only when ordered with marking on switch (see General Specs)				Toggle Position/Connected Terminals				Electrical Capacity				α = Angle of Throw
Model	* Approvals			Pole & Throw	Down	Center	Up	Resistive			Inductive	
								AC 125V	AC 250V	DC 30V	AC 125V PF 0.6	
S301F	✓	✓	✓	SPST	ON 1-3	NONE	OFF —	15A	6A	20A	10A	32°

Throw & Schematics:

SPST



Note: Terminal numbers are actually on the switch

Notes: Standard Hardware: AT503M Face Hex Nut, AT506M Locking Ring, AT508 Lockwasher, AT527M Backup Hex Nut. See Accessories & Hardware section. Optional Splashproof Boot Assemblies: AT401 & AT4181 boots plus hex nut & o-ring. See Accessories & Hardware section.



S301F

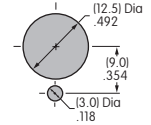
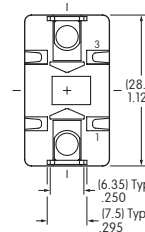
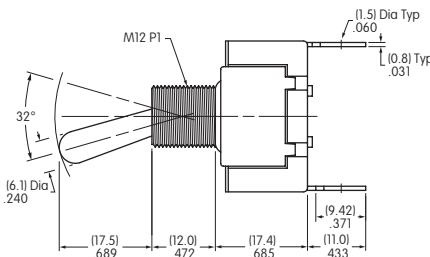
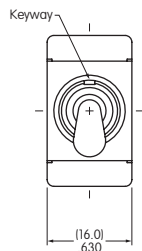

Maximum Panel Thickness: .185" (4.7mm)

DOUBLE POLE WITH QUICK CONNECT

* UL & cULus recognized only when ordered with marking on switch (see General Specs)				Toggle Position/Connected Terminals () = Momentary				Electrical Capacity				α = Angle of Throw
Model	* Approvals			Pole & Throw	Down	Center	Up	Resistive			Inductive	
								AC 125V	AC 250V	DC 30V	AC 125V PF 0.6	
S331F	✓	✓	—	DPST	ON 1-3 4-6	NONE	OFF —	20A	20A	20A	10A	25°
S332F	✓	✓	—	DPDT	ON 2-3 5-6	NONE	ON 2-1 5-4	20A	15A	20A	10A	25°
S333F	✓	✓	—	DPDT	ON 2-3 5-6	OFF	ON 2-1 5-4	20A	15A	20A	10A	30°
S335F	✓	✓	—	DPDT	ON 2-3 5-6	NONE	(ON) 2-1 5-4	15A	6A	20A	8A	25°

Throw & Schematics:

DPST



DPDT

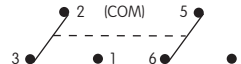

Note: Terminal numbers are actually on the switch

Notes: Standard Hardware: AT503M Face Hex Nut, AT506M Locking Ring, AT508 Lockwasher, AT527M Backup Hex Nut. See Accessories & Hardware section. Optional Splashproof Boot Assemblies: AT401 & AT4181 boots plus hex nut & o-ring. See Accessories & Hardware section.



S332F

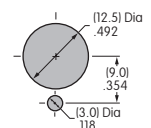
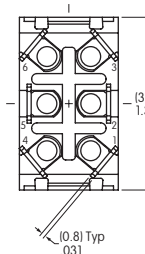
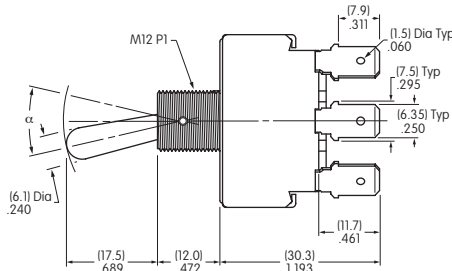
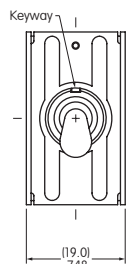

Maximum Panel Thickness: .185" (4.7mm)

S331F does not have terminals 2 & 5

GENERAL SPECIFICATIONS FOR S31 ~ S49

Electrical Capacity (Resistive & Inductive Load)

Power Level: Shown in the following tables

Other Ratings

Contact Resistance: 10 milliohms maximum
Insulation Resistance: 1,000 megohms minimum @ 500V DC
Dielectric Strength: 2,000V AC minimum for 1 minute minimum
Mechanical Life: 50,000 operations minimum
Electrical Life: 25,000 operations minimum for all models (Resistive Load)
 6,000 operations minimum for S31, S32, S33, S31F, S32F, S33F, S31T, S32T, S33T;
 S41/S41R, S42/S42R, S43/S43R, S41F, S42F, S43F, S41T, S42T, S43T
 (Inductive Load)
Angle of Throw (α): Shown on following tables

Materials & Finishes

Toggle: PBT resin for flatted lever; brass with chrome plating for all others
Bushing: Brass with chrome plating
Case: Phenolic resin
Case Cover: Steel with chromate plating over zinc plating
Movable Contactor: Copper with silver plating
Movable Contacts: Silver alloy capped on copper with silver plating
Stationary Contacts: Silver alloy capped on copper with silver plating
Terminals: Brass with tin plating

Environmental Data

Operating Temp Range: -10°C through +70°C (+14°F through +158°F)

Installation

Mounting Torque: 2.94Nm (26 lb•in) for double nut
Maximum Panel Thickness: Shown beneath panel cutout in switch dimension drawings
Soldering Time & Temperature: Manual Soldering: See Profile A in Supplement section.

Standards & Certifications

UL: **File No. E44145 - Recognized only when ordered with marking on switch.**
 Add "/U" or "/CUL" to end of part number to order UL recognized switch.
 UL or cULus recognition designated beside part numbers on following pages.
 See Supplement section to find UL or cULus rating details.

CSA: **File No. 023535_0_000 - Certified only when ordered with marking on switch.**
 Add "/C" to end of part number to order CSA certified switch.
 CSA certification designated beside part numbers on following pages.
 See Supplement section to find CSA rating details.

A
Toggles

Rockers

Pushbuttons

Illuminated PB

Programmable

Keylocks

Rotaries

Slides

Tactiles

Tilt

Touch

Indicators

Accessories

Supplement

Toggles
A

THREE POLE WITH SOLDER LUG

Model	* Approvals			Pole & Throw	Toggle Position/Connected Terminals () = Momentary						Electrical Capacity			
	UL	cULus	SP		Down Keyway	Center	Up	Resistive			Inductive AC 125V PF 0.6	α = Angle of Throw		
								AC 125V	AC 250V	DC 30V				
S31	✓	✓	✓	3PST	ON	1-3 4-6 7-9	NONE	OFF	—	20A	9A	20A	10A	25°
S32	✓	✓	✓	3PDT	ON	2-3 5-6 8-9	NONE	ON	2-1 5-4 8-7	20A	9A	20A	10A	25°
S33	✓	✓	✓	3PDT	ON	2-3 5-6 8-9	OFF	ON	2-1 5-4 8-7	20A	9A	20A	10A	30°
S35	✓	✓	✓	3PDT	ON	2-3 5-6 8-9	NONE	(ON)	2-1 5-4 8-7	15A	6A	20A	8A	25°
S38	✓	✓	✓	3PDT	(ON)	2-3 5-6 8-9	OFF	(ON)	2-1 5-4 8-7	15A	6A	15A	8A	25°
S39	✓	✓	✓	3PDT	ON	2-3 5-6 8-9	OFF	(ON)	2-1 5-4 8-7	15A	6A	15A	8A	25°

Throw & Schematics:



Note: Terminal numbers are on the switch

Notes: Standard Hardware: AT503M Face Hex Nut, AT506M Locking Ring, AT508 Lockwasher, AT527M Backup Hex Nut. See Accessories & Hardware section. Optional Splashproof Boot Assemblies: AT401 & AT4181 boots plus hex nut & o-ring. See Accessories & Hardware section.



S32

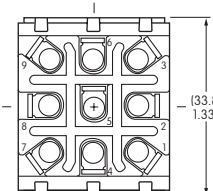
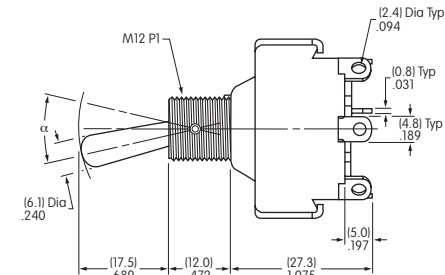
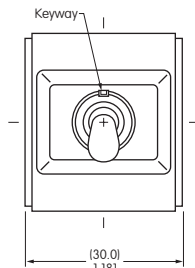

S31 does not have terminals 2, 5, & 8

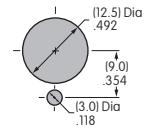

Maximum Panel Thickness: .181" (4.6mm)

FOUR POLE WITH SOLDER LUG

Model Suffix R = Flatted Lever	* Approvals			Pole & Throw	Toggle Position/Connected Terminals () = Momentary						Electrical Capacity			
	UL	cULus	SP		Down Keyway	Center	Up	Resistive			Inductive AC 125V PF 0.6	α = Angle of Throw		
								AC 125V	AC 250V	DC 30V				
S41/S41R	✓	✓	✓	4PST	ON	1-3 4-6 7-9 10-12	NONE	OFF	—	20A	9A	20A	10A	25°
S42/S42R	✓	✓	✓	4PDT	ON	2-3 5-6 8-9 11-12	NONE	ON	2-1 5-4 8-7 11-10	20A	9A	20A	10A	25°
S43/S43R	✓	✓	✓	4PDT	ON	2-3 5-6 8-9 11-12	OFF	ON	2-1 5-4 8-7 11-10	20A	9A	20A	10A	30°
S45	—	✓	—	4PDT	ON	2-3 5-6 8-9 11-12	NONE	(ON)	2-1 5-4 8-7 11-10	15A	6A	20A	8A	25°
S48/S48R	✓	✓	—	4PDT	(ON)	2-3 5-6 8-9 11-12	OFF	(ON)	2-1 5-4 8-7 11-10	15A	6A	20A	8A	25°
S49/S49R	✓	✓	—	4PDT	ON	2-3 5-6 8-9 11-12	OFF	(ON)	2-1 5-4 8-7 11-10	15A	6A	20A	8A	25°

Throw & Schematics:



Note: Terminal numbers are on the switch

Notes: Standard Hardware for **Bat Lever**: AT503M Face Hex Nut, AT506M Locking Ring, AT508 Lockwasher, AT527M Backup Hex Nut; for **Flatted Lever (R)**: AT504M Knurled Face Nut, AT508 Lockwasher, AT527M Backup Hex Nut. See Accessories & Hardware section. Optional Splashproof Boot Assemblies (only for bat lever models): AT401 & AT4181 boots plus hex nut and o-ring. See Accessories & Hardware section.



S41R

Bat lever dimensions are same as on S30 models above. S41 and S41R do not have terminals 2, 5, 8, & 11.

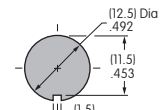
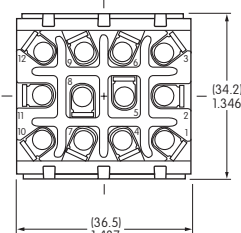
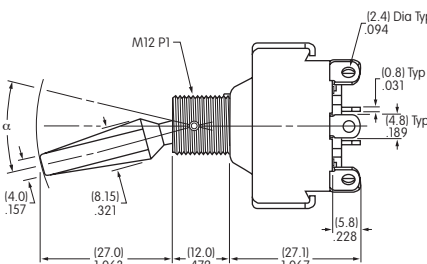
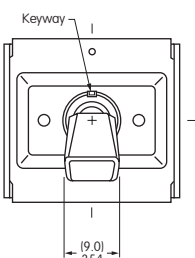

Max. Panel Thickness: .220" (5.6mm)

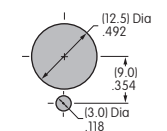

Max. Panel Thickness: .181" (4.6mm)

Rockers

Pushbuttons

Illuminated PB

Programmable

Keylocks

Rotaries

Slides

Tactiles

Tilt







Touch

Indicators

Accessories

Supplement

THREE POLE WITH SCREW LUG

* UL, cULus & CSA recognized only when ordered with marking on switch (see General Specs)			Toggle Position/Connected Terminals						Electrical Capacity				
Model	* Approvals			Pole & Throw	Down 	Center 	Up 	Resistive			Inductive		$\alpha =$ Angle of Throw
								AC 125V	AC 250V	DC 30V	AC 125V PF 0.6	AC 250V PF 0.6	
S31T	✓	✓	✓	3PST	ON 1-3 4-6 7-9	NONE	OFF —	20A	9A	20A	10A	5A	25°
S32T	✓	✓	✓	3PDT	ON 2-3 5-6 8-9	NONE	ON 2-1 5-4 8-7	20A	9A	20A	10A	5A	25°
S33T	✓	✓	✓	3PDT	ON 2-3 5-6 8-9	OFF	ON 2-1 5-4 8-7	20A	9A	20A	10A	5A	30°

Throw & Schematics:

3PST:  INTERNAL CONNECTION

3PDT:  (COM) 8

Note: Terminal numbers are on the switch

Notes: Standard Hardware: AT503M Face Hex Nut, AT506M Locking Ring, AT508 Lockwasher, AT527M Backup Hex Nut. See Accessories & Hardware section.
Optional Splashproof Boot Assemblies: AT401 & AT4181 boots plus hex nut & o-ring. See Accessories & Hardware section.

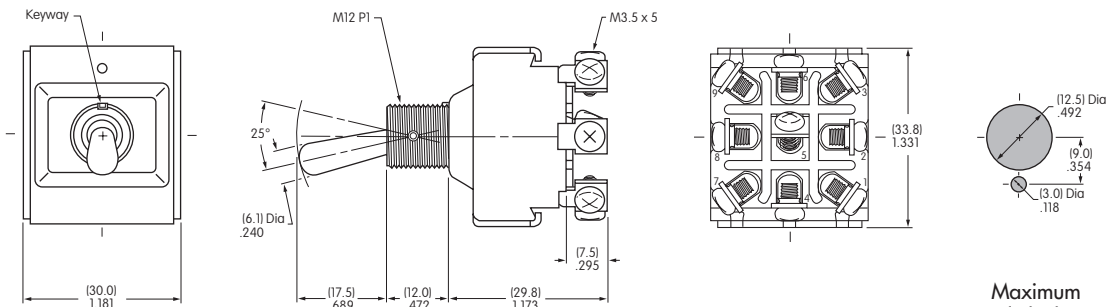







S31T does not have terminals 2, 5, & 8

Maximum Panel Thickness: .181" (4.6mm)

S32T

FOUR POLE WITH SCREW LUG

* UL, cULus & CSA recognized only when ordered with marking on switch (see General Specs)			Toggle Position/Connected Terminals						Electrical Capacity				
Model	* Approvals			Pole & Throw	Down 	Center 	Up 	Resistive			Inductive		$\alpha =$ Angle of Throw
								AC 125V	AC 250V	DC 30V	AC 125V PF 0.6	AC 250V PF 0.6	
S41T	✓	✓	✓	4PST	ON 1-3 4-6 7-9 10-12	NONE	OFF —	20A	9A	20A	10A	5A	25°
S42T	✓	✓	✓	4PDT	ON 2-3 5-6 8-9 11-12	NONE	ON 2-1 5-4 8-7 11-10	20A	9A	20A	10A	5A	25°
S43T	✓	✓	✓	4PDT	ON 2-3 5-6 8-9 11-12	OFF	ON 2-1 5-4 8-7 11-10	20A	9A	20A	10A	5A	30°

Throw & Schematics:

4PST:  INTERNAL CONNECTION

4PDT:  (COM) 8

Note: Terminal numbers are on the switch

Notes: Standard Hardware: AT503M Face Hex Nut, AT506M Locking Ring, AT508 Lockwasher, AT527M Backup Hex Nut. See Accessories & Hardware section.
Optional Splashproof Boot Assemblies: AT401 & AT4181 boots plus hex nut & o-ring. See Accessories & Hardware section.

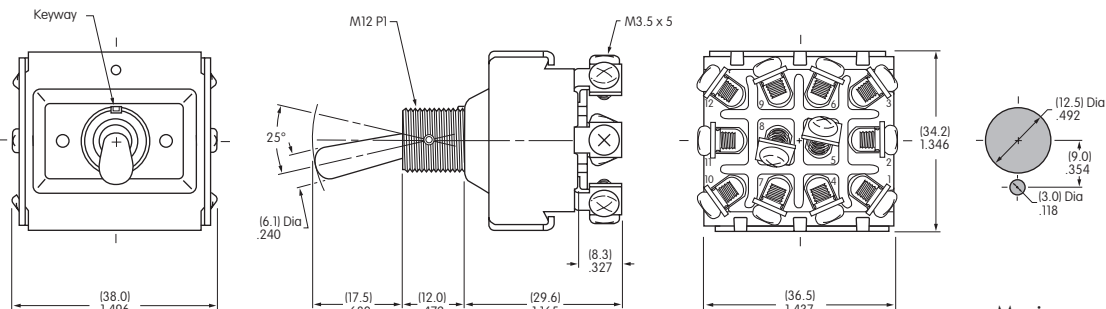

S41T does not have terminals 2, 5, 8, & 11

Maximum Panel Thickness: .181" (4.6mm)

S42T

Toggles **A**

THREE POLE WITH QUICK CONNECT

* UL, cULus & CSA recognized only when ordered with marking on switch (see General Specs)				Toggle Position/Connected Terminals						Electrical Capacity			
Model	* Approvals			Pole & Throw	Down	Center	Up	Resistive			Inductive	$\alpha =$ Angle of Throw	
								AC 125V	AC 250V	DC 30V	AC 125V PF 0.6		
S31F	✓	✓	✓	3PST	ON 1-3 4-6 7-9	NONE	OFF	20A	9A	20A	10A	25°	
S32F	✓	✓	✓	3PDT	ON 2-3 5-6 8-9	NONE	ON 2-1 5-4 8-7	20A	9A	20A	10A	25°	
S33F	✓	✓	✓	3PDT	ON 2-3 5-6 8-9	OFF	ON 2-1 5-4 8-7	20A	9A	20A	10A	30°	

Throw & Schematics:



Note: Terminal numbers are on the switch

Notes: Standard Hardware: AT503M Face Hex Nut, AT506M Locking Ring, AT508 Lockwasher, AT527M Backup Hex Nut. See Accessories & Hardware section. Optional Splashproof Boot Assemblies: AT401 & AT4181 boots plus hex nut & o-ring. See Accessories & Hardware section.



S31F

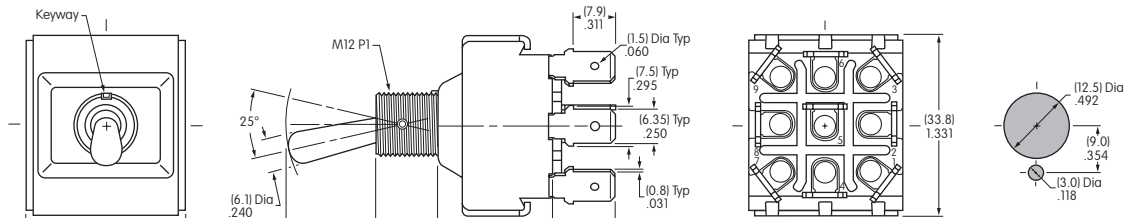

S31F does not have terminals 2, 5, & 8

Maximum Panel Thickness: .181" (4.6mm)

FOUR POLE WITH QUICK CONNECT

* UL, cULus & CSA recognized only when ordered with marking on switch (see General Specs)				Toggle Position/Connected Terminals						Electrical Capacity			
Model	* Approvals			Pole & Throw	Down	Center	Up	Resistive			Inductive	$\alpha =$ Angle of Throw	
								AC 125V	AC 250V	DC 30V	AC 125V PF 0.6		
S41F	✓	✓	✓	4PST	ON 1-3 4-6 7-9 10-12	NONE	OFF	20A	9A	20A	10A	25°	
S42F	✓	✓	✓	4PDT	ON 2-3 5-6 8-9 11-12	NONE	ON 2-1 5-4 8-7 11-10	20A	9A	20A	10A	25°	
S43F	✓	✓	✓	4PDT	ON 2-3 5-6 8-9 11-12	OFF	ON 2-1 5-4 8-7 11-10	20A	9A	20A	10A	30°	

Throw & Schematics:



Note: Terminal numbers are on the switch

Notes: Standard Hardware: AT503M Face Hex Nut, AT506M Locking Ring, AT508 Lockwasher, AT527M Backup Hex Nut. See Accessories & Hardware section. Optional Splashproof Boot Assemblies: AT401 & AT4181 boots plus hex nut & o-ring. See Accessories & Hardware section.



S42F

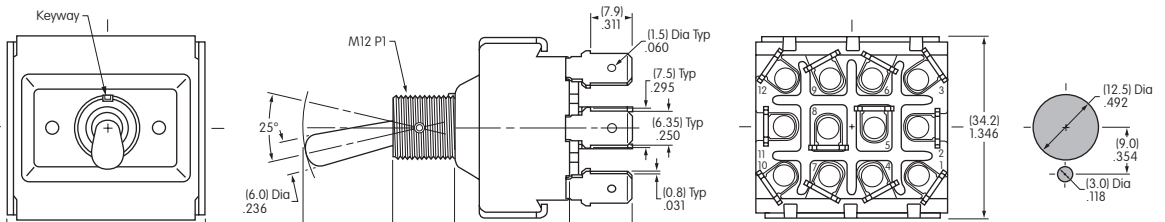

S41F does not have terminals 2, 5, 8, & 11

Maximum Panel Thickness: .181" (4.6mm)

Rockers

Pushbuttons

Illuminated PB

Programmable

Keylocks

Rotaries

Slides

Tactiles

Tilt

Touch

Indicators

Accessories

Supplement

GENERAL SPECIFICATIONS FOR S421 ~ S429

A
Toggles

Electrical Capacity (Resistive & Inductive Load)

Power Level: Shown in the following tables

Rockers

Other Ratings

Contact Resistance: 10 milliohms maximum
Insulation Resistance: 1,000 megohms minimum @ 500V DC
Dielectric Strength: 2,000V AC minimum for 1 minute minimum
Mechanical Life: 50,000 operations minimum
Electrical Life: 15,000 operations minimum
Angle of Throw (α): Shown in tables on following pages

Pushbuttons

Illuminated PB

Materials & Finishes

Toggle: Brass with chrome plating
Bushing: Brass with chrome plating
Case: Melamine phenol
Case Cover: Steel with chromate plating over zinc plating
Movable Contactor: Copper with silver plating
Movable Contacts: Silver alloy capped on copper with silver plating
Stationary Contacts: Silver alloy capped on copper with silver plating
Terminals: Brass with tin plating

Programmable

Keylocks

Rotaries

Environmental Data

Operating Temp Range: -10°C through +70°C (+14°F through +158°F)

Slides

Installation

Mounting Torque: 2.94Nm (26 lb·in) for double nut
Maximum Panel Thickness: Shown beneath panel cutout in switch dimension drawings
Soldering Time & Temperature: Manual Soldering: See Profile A in Supplement section.

Tactiles

Tilt

Touch



Indicators

Accessories

Supplement

Toggles **A**

DOUBLE POLE WITH SOLDER LUG

Model	Approvals		Pole & Throw	Toggle Position/Connected Terminals () = Momentary						Electrical Capacity				
	UL	CS		Down 	Center 	Up 	Resistive		Inductive		Motor Load AC 125V	α = Angle of Throw		
							AC 125V	AC 250V	PF 0.75 - 0.8 AC 125V	AC 250V				
S421	—	—	DPST	ON	1-3 4-6	NONE	OFF	—	20A	20A	20A	20A	750W	24°
S422	—	—	DPDT	ON	2-3 5-6	NONE	ON	2-1 5-4	20A	20A	20A	20A	750W	24°
S423	—	—	DPDT	ON	2-3 5-6	OFF	ON	2-1 5-4	20A	20A	20A	20A	750W	28°
S425	—	—	DPDT	ON	2-3 5-6	NONE	(ON)	2-1 5-4	15A	15A	15A	15A	400W	24°
S428	—	—	DPDT	(ON)	2-3 5-6	OFF	(ON)	2-1 5-4	15A	15A	15A	15A	400W	24°
S429	—	—	DPDT	ON	2-3 5-6	OFF	(ON)	2-1 5-4	15A	15A	15A	15A	400W	24°

Throw & Schematics:



Note: Terminal numbers are on the switch

Notes: Standard Hardware: AT503M Face Hex Nut, AT506M Locking Ring, AT508 Lockwasher, AT527M Backup Hex Nut. See Accessories & Hardware section.
Optional Splashproof Boot Assemblies: AT401 & AT4181 boots plus hex nut & o-ring. See Accessories & Hardware section.



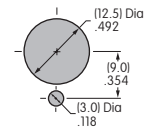
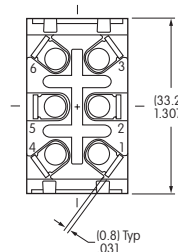
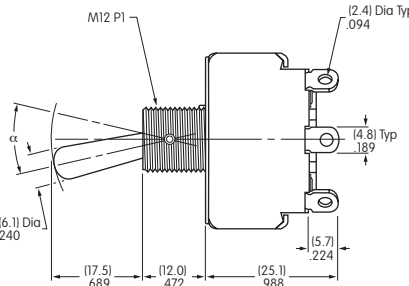
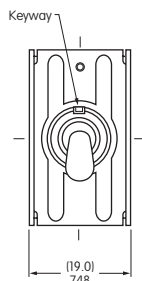

S422



Maximum Panel Thickness: .185" (4.7mm)

S421 does not have terminals 2 & 5

DOUBLE POLE WITH SCREW LUG

Model	Approvals		Pole & Throw	Toggle Position/Connected Terminals () = Momentary						Electrical Capacity				
	UL	CS		Down 	Center 	Up 	Resistive		Inductive		Motor Load AC 125V	α = Angle of Throw		
							AC 125V	AC 250V	PF 0.75 - 0.8 AC 125V	AC 250V				
S421T	—	—	DPST	ON	1-3 4-6	NONE	OFF	—	20A	20A	20A	20A	750W	24°
S422T	—	—	DPDT	ON	2-3 5-6	NONE	ON	2-1 5-4	20A	20A	20A	20A	750W	24°
S423T	—	—	DPDT	ON	2-3 5-6	OFF	ON	2-1 5-4	20A	20A	20A	20A	750W	28°
S425T	—	—	DPDT	ON	2-3 5-6	NONE	(ON)	2-1 5-4	15A	15A	15A	15A	400W	24°
S428T	—	—	DPDT	(ON)	2-3 5-6	OFF	(ON)	2-1 5-4	15A	15A	15A	15A	400W	24°
S429T	—	—	DPDT	ON	2-3 5-6	OFF	(ON)	2-1 5-4	15A	15A	15A	15A	400W	24°

Throw & Schematics:



Note: Terminal numbers are on the switch

Notes: Standard Hardware: AT503M Face Hex Nut, AT506M Locking Ring, AT508 Lockwasher, AT527M Backup Hex Nut. See Accessories & Hardware section.
Optional Splashproof Boot Assemblies: AT401 & AT4181 boots plus hex nut & o-ring. See Accessories & Hardware section.



S423T

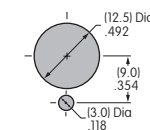
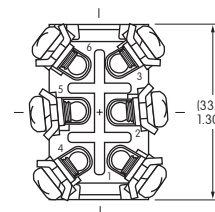
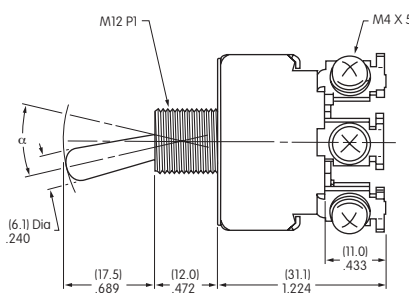
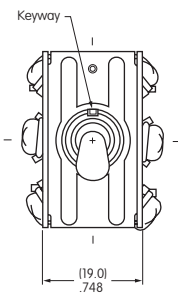

Maximum Panel Thickness: .185" (4.7mm)

S421T does not have terminals 2 & 5

Rockers

Pushbuttons

Illuminated PB

Programmable

Keylocks

Rotaries

Slides

Tactiles

Tilt

Touch

Indicators

Accessories

Supplement

GENERAL SPECIFICATIONS FOR S800s ~ S732

Electrical Capacity (Resistive & Inductive Load)

Power Level: Shown in the following tables

Other Ratings

Contact Resistance: 10 milliohms maximum
Insulation Resistance: 1,000 megohms minimum @ 500V DC
Dielectric Strength: 2,000V AC minimum for 1 minute minimum for S800s & S800Ds
 3,000V AC minimum for 1 minute minimum for S732
Mechanical Life: 50,000 operations minimum
Electrical Life: 10,000 operations minimum for S800Ds
 25,000 operations minimum for S800s & S732

Materials & Finishes

Toggle: Brass with nickel plating for S732
 Brass with chrome plating for S800s & S800Ds
Bushing: Brass with chrome plating
Case: Phenolic resin for S732; melamine phenol for S800s
Case Cover: Steel with chromate plating over zinc plating
Movable Contactor Plate: Copper with silver plating
Movable & Stationary Contacts: Silver alloy capped on copper with silver plating
Common Terminals: Brass
Contact Terminals: Brass with silver or nickel plating

Environmental Data

Operating Temp Range: -10°C through +70°C (+14°F through +158°F)

Installation

Mounting Torque: 2.94Nm (26 lb•in) for double nut
Maximum Panel Thickness: Shown beneath panel cutout in switch dimension drawings

Standards & Certifications

UL: File No. E44145 - Recognized only when ordered with marking on switch.
 Add "/U" or "/CUL" to end of part number to order UL recognized switch.
 UL or cULus recognition designated beside part numbers on following pages.
 See Supplement section to find UL or cULus rating details.

CSA: File No. 023535_0_000 - Certified only when ordered with marking on switch.
 Add "/C" to end of part number to order CSA certified switch.
 CSA certification designated beside part numbers on following pages.
 See Supplement section to find CSA rating details.

A
Toggles

Rockers

Pushbuttons

Illuminated PB

Programmable

Keylocks

Rotaries

Slides

Tactiles

Tilt

Touch

Indicators

Accessories

Supplement

DOUBLE POLE WITH SCREW LUG

* UL, cULus & CSA recognized only when ordered with marking on switch (see General Specs)			Toggle Position/Connected Terminals				Electrical Capacity							
Model	* Approvals			Pole & Throw	Down	Center	Up	Resistive				Inductive		Motor Load
	UL	cULus	CSA		Keyway	None	None	AC 125V	AC 250V	DC 30V	DC 125V	AC 125V PF 0.6	AC 250V PF 0.6	AC 125V
S821	✓	✓	✓	DPST	ON 2-3 5-6	NONE	OFF —	30A	30A	30A	1A	30A	15A	750W
S822	✓	✓	✓	DPDT	ON 2-3 5-6	NONE	ON 2-1 5-4	30A	30A	30A	1A	30A	15A	—
S823	✓	✓	✓	DPDT	ON 2-3 5-6	OFF	ON 2-1 5-4	30A	30A	30A	1A	30A	15A	—



Notes: Standard Hardware: AT503M Face Hex Nut, AT506M Locking Ring, AT508 Lockwasher, AT527M Backup Hex Nut. See Accessories & Hardware section.
 Optional Splashproof Boot Assembly: AT401 boot plus hex nut & o-ring. See Accessories & Hardware section.

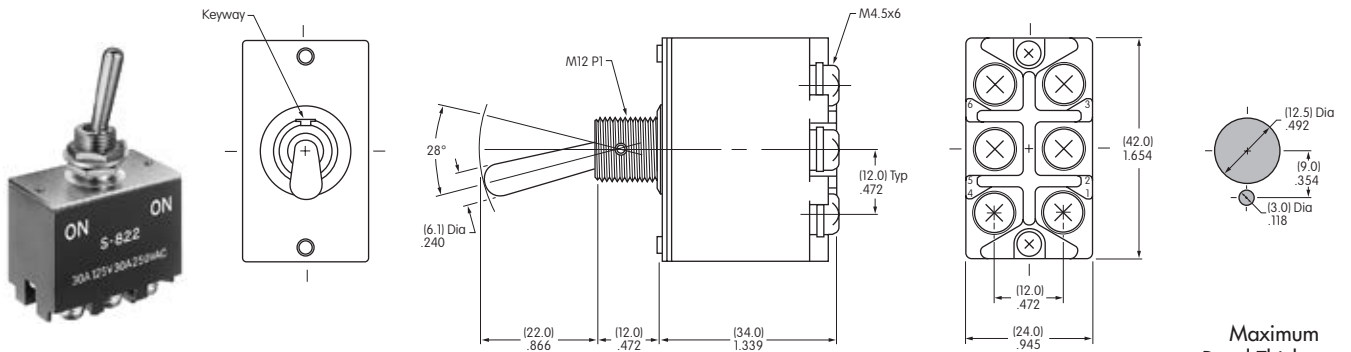

S822

S821 does not have terminals 1 & 4

Maximum Panel Thickness: .177" (4.5mm)

THREE POLE WITH SCREW LUG

* UL, cULus & CSA recognized only when ordered with marking on switch (see General Specs)			Toggle Position/Connected Terminals				Electrical Capacity						
Model	* Approvals			Pole & Throw	Down	Center	Up	Resistive				Inductive	
	UL	cULus	CSA		Keyway	None	None	AC 125V	AC 250V	DC 30V	DC 125V	AC 125V PF 0.6	AC 250V PF 0.6
S831	✓	✓	✓	3PST	ON 2-3 5-6 8-9	NONE	OFF —	30A	30A	30A	1A	30A	15A
S832	✓	✓	✓	3PDT	ON 2-3 5-6 8-9	NONE	ON 2-1 5-4 8-7	30A	30A	30A	1A	30A	15A
S833	✓	✓	✓	3PDT	ON 2-3 5-6 8-9	OFF	ON 2-1 5-4 8-7	30A	30A	30A	1A	30A	15A

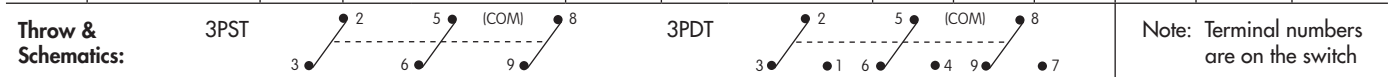

Notes: Standard Hardware: AT503M Face Hex Nut, AT506M Locking Ring, AT508 Lockwasher, AT527M Backup Hex Nut. See Accessories & Hardware section.
 Optional Splashproof Boot Assembly: AT401 boot plus hex nut & o-ring. See Accessories & Hardware section.

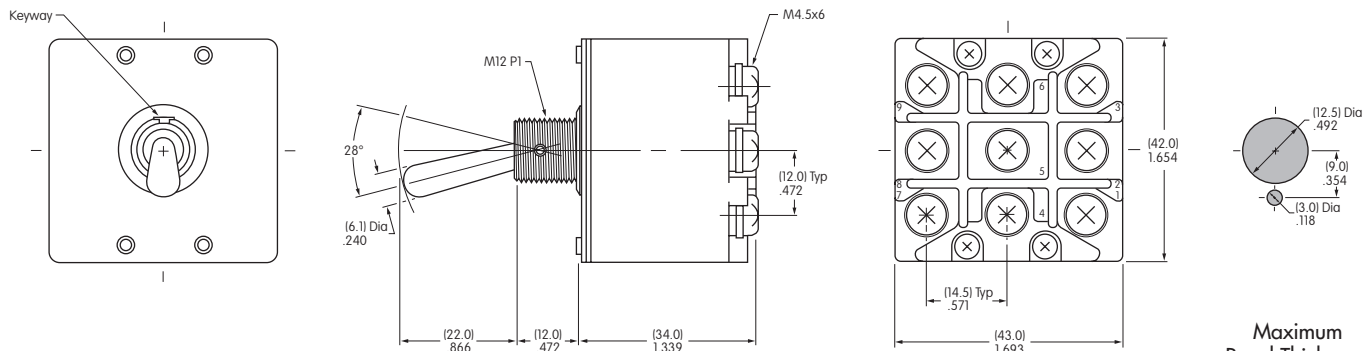



S833

S831 does not have terminals 1, 4 & 7

Maximum Panel Thickness: .177" (4.5mm)

DOUBLE POLE WITH SCREW LUG & FLATTED LEVER

* UL, cULus & CSA recognized only when ordered with marking on switch (see General Specs)

Model	*Approvals			Pole & Throw	Toggle Position/Connected Terminals					Electrical Capacity										
	UL	cULus	CSA		Down 	Center 	Up 	Resistive				Inductive L/R = 3ms								
								DC 30V	DC 48V	DC 125V	DC 250V	DC 400V	DC 24V	DC 48V	DC 125V	DC 250V				
S821D	✓	✓	✓	DPST	ON	2-3	5-6	NONE	OFF	—	30A	30A	20A	15A	4A (10A)	15A	10A	6A	3A	
S822D	✓	✓	✓	DPDT	ON	2-3	5-6	NONE	ON	2-1	5-4	30A	30A	20A	15A	4A	15A	10A	6A	3A
S823D	✓	✓	✓	DPDT	ON	2-3	5-6	OFF	ON	2-1	5-4	30A	30A	15A	7.5A	—	15A	10A	6A	3A

() capacity is due to wiring. Refer to instructions below.

Throw & Schematics:

DPST

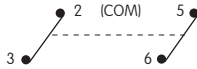

DPDT

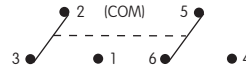

Note: Terminal numbers are on the switch

Notes: Standard Hardware: AT503M Face Hex Nut, AT506M Locking Ring, AT508 Lockwasher, AT527M Backup Hex Nut. See Accessories & Hardware section.

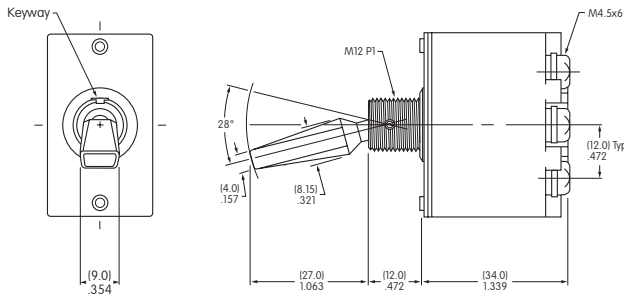

Double Pole

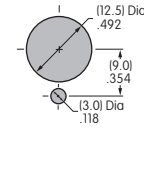
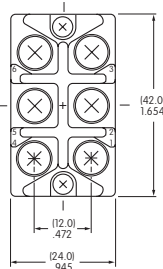

Maximum Panel Thickness: .177" (4.5mm)



S822D

S821D does not have terminals 1 & 4

400V DC WIRING INSTRUCTIONS

1. DC Switch Use

- Middle terminal shall be the minus pole when using DC circuit. Switch case is marked with (+) and (-).
- Do not store near (5cm) highly magnetic items.
- If actuation is interrupted when switching from ON to OFF, arcing may continue and switch could be burned.

2. Wiring for DC400V 10A

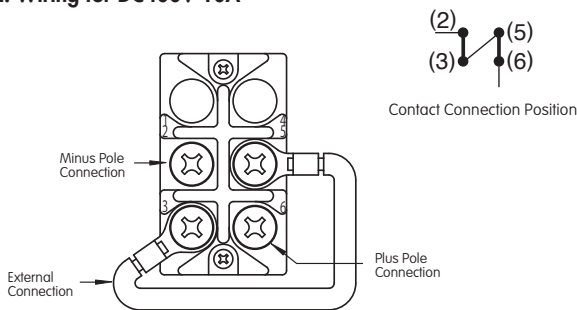

3. Inductive Load

Inductive loads produce an arc caused by counter-electromotive force when opening the circuit. Recommend inserting spark elimination circuit. Contact factory for details.

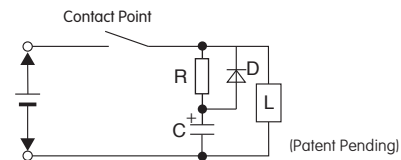

4. Compressed Terminal Connection

When connecting screw terminal with compressed terminal, select compressed terminal using drawing below.

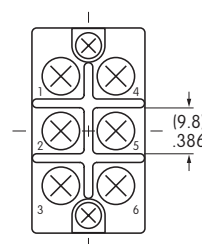

THREE POLE WITH SCREW LUG & FLATTED LEVER

* UL, cULus & CSA recognized only when ordered with marking on switch (see General Specs)			Toggle Position/Connected Terminals			Electrical Capacity									
Model	* Approvals			Pole & Throw	Down	Center	Up	Resistive				Inductive L/R = 3ms			
	UL	cULus	CSA		Keyway			DC 30V	DC 48V	DC 125V	DC 250V	DC 24V	DC 48V	DC 125V	DC 250V
S831D	✓	✓	✓	3PST	ON 2-3 5-6 8-9	NONE	OFF —	30A	30A	15A	7.5A	15A	10A	6A	3A
S832D	✓	✓	✓	3PDT	ON 2-3 5-6 8-9	NONE	ON 2-1 5-4 8-7	30A	30A	15A	7.5A	15A	10A	6A	3A
S833D	✓	✓	✓	3PDT	ON 2-3 5-6 8-9	OFF	ON 2-1 5-4 8-7	30A	30A	15A	7.5A	15A	10A	6A	3A

Throw & Schematics:

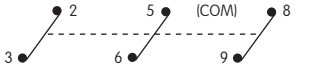
3PST: 

3PDT: 

Note: Terminal numbers are on the switch

Notes: Standard Hardware: AT503M Face Hex Nut, AT506M Locking Ring, AT508 Lockwasher, AT527M Backup Hex Nut. See Accessories & Hardware section.

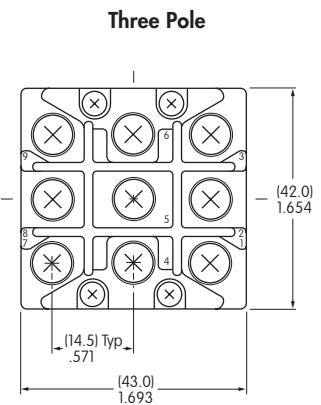
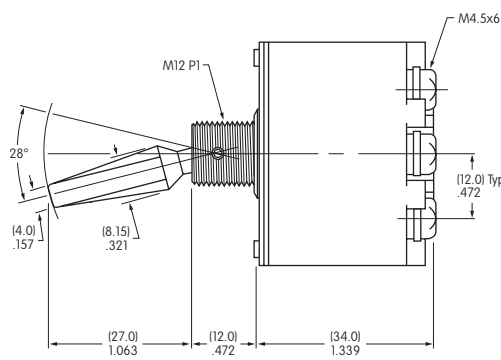
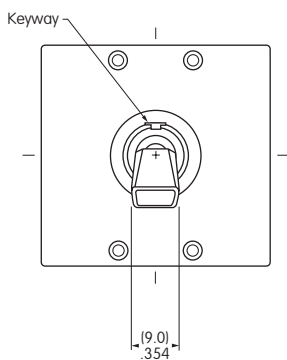

S831D does not have terminals 1, 4 & 7.
Positive (+) must be connected to end terminals & negative to common terminals.



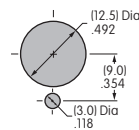

S832D



Maximum Panel Thickness: .177" (4.5mm)

DOUBLE POLE WITH SCREW LUG

Model	Approvals UL SP	Pole & Throw	Toggle Position/Connected Terminals			Electrical Capacity			
			Down 	Center 	Up 	Resistive			Inductive
						AC 125V	AC 250V	DC 30V	AC 125V PF 0.6
S732	— —	DPDT	ON 2-3 5-6	NONE	ON 2-1 5-4	50A	30A	50A	25A

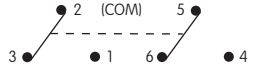
Throw & Schematics: DPDT 

Note: Terminal numbers are on the switch

Notes: Standard Hardware: AT503M Face Hex Nut, AT506M Locking Ring, AT508 Lockwasher, AT527M Backup Hex Nut. See Accessories & Hardware section.

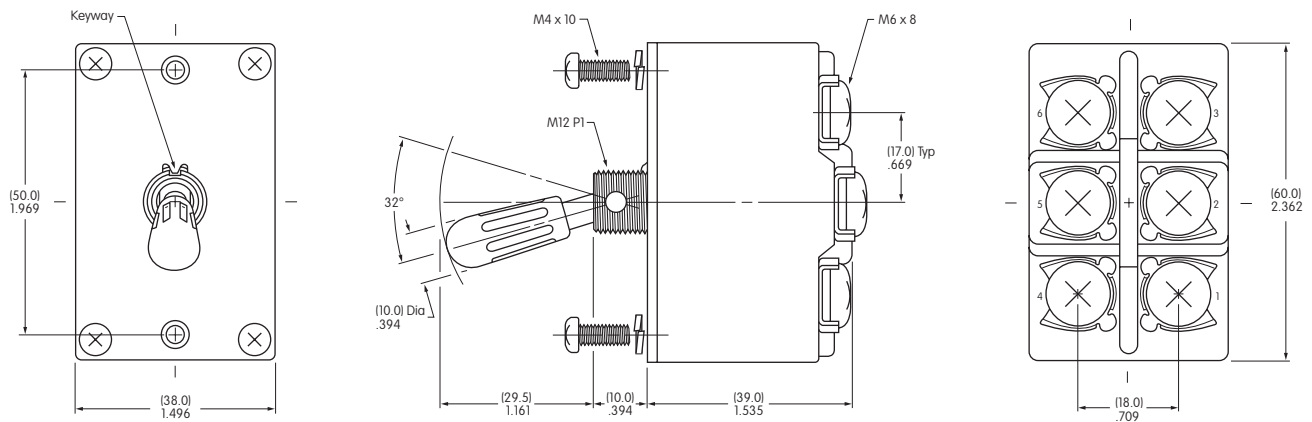

Cap of phenolic resin is black

Panel Mount with Mounting Screws

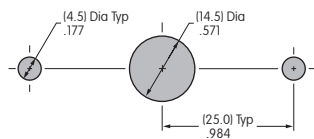

Maximum Panel Thickness: .158" (4.0mm)

Panel Mount with Bushing Hardware

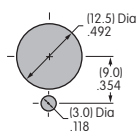

Maximum Panel Thickness: .079" (2.0mm)

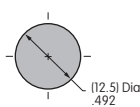

Maximum Panel Thickness: .118" (3.0mm)

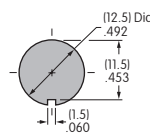

Maximum Panel Thickness: .118" (3.0mm)



S732