

DK2.5N

DIN Rail Terminal Blocks > Screw Connection

Date:2023-03-30Version:1.2

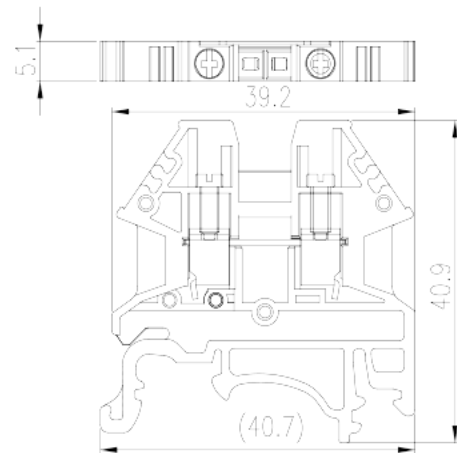
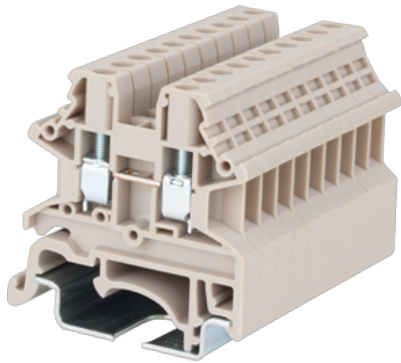

The web catalog is for reference only. Dinkle remains the right of product modification and engineering change of the design. The final product is made according to engineering drawing.

Product Description

M2.5, 600V, 20A, Beige (default)

General information

Short description	DIN rail terminal blocks, Feed through terminal blocks
Category	Feed through terminal blocks
Color	Beige (default)
Connection method	Screw connection
Type of locking	Rail mounting
Length (mm)	40.7
Width (mm)	5.1
Height (mm)	39.6
Number of positions	□1P
Level	Single level
Connection points	2

Material information

Insulation material	PA
Insulation material group	I
Flame retardant rating , compliant with UL94	V0

Insulation resistance

 $\geq 500\text{M}\Omega$ at DC 500V

Connection data-IEC

Rated voltage (V)	1000
Rated current (A)	24
Rated voltage (III/3)(V)	1000
Rated impulse voltage (II/2)(KV)	8
Rated impulse voltage (III/2)(KV)	8
Rated impulse voltage (III/3)(KV)	8
Conductor cross section solid. min (mm ²)	0.34
Conductor cross section solid.max (mm ²)	2.5
Conductor cross section stranded. min (mm ²)	0.34
Conductor cross section stranded. max (mm ²)	2.5
Conductor cross section flexible, with min ferrule without plastic sleeve (mm ²)	0.34
Conductor cross section flexible, with max ferrule without plastic sleeve (mm ²)	2.5
Conductor cross section flexible, with min ferrule with plastic sleeve (mm ²)	0.34
Conductor cross section flexible, with max ferrule with plastic sleeve (mm ²)	2.5
2 conductors with same cross section, solid, min (mm ²)	0.34
2 conductors with same cross section, solid, max (mm ²)	2.5
2 conductors with same cross section, stranded, min (mm ²)	0.34
2 conductors with same cross section, stranded, max (mm ²)	2.5
2 conductors with same cross section flexible, with min ferrule without plastic sleeve (mm ²)	0.5
2 conductors with same cross section flexible, with max ferrule without plastic sleeve (mm ²)	1.5
2 conductors with same cross section flexible, min twin ferrules with plastic sleeve (mm ²)	0.5
2 conductors with same cross section flexible, max twin ferrules with plastic sleeve (mm ²)	1.5
Screw thread	M2.5
Slotted screwdriver size (Blade thickness x Width)(mm)	0.6x3.5
Philips screwdriver size	PH0
Rated torque (N.m)	0.4

Stripping Length (mm)	9~11
Mounting rail	TS-35
End cover plate required	YES
Grounding connections	NO

Connection data-UL

Rated voltage (UL/CUL Group B)(V)	600
Rated current (UL/CUL Group B)(A)	20
Rated voltage (UL/CUL Group C)(V)	600
Rated current (UL/CUL Group C)(A)	20
Rated voltage (UL/CUL Group D)(V)	600
Rated current (UL/CUL Group D)(A)	5
Min. solid wire connection (AWG) acc. to UL/CUL	22
Max. solid wire connection AWG acc. to UL/CUL	12
Min. stranded wire connection AWG acc. to UL/CUL	22
Max. stranded wire connection AWG acc. to UL/CUL	12

Environment & Safety

Back of the hand protection (YES or NO)	YES
Finger protection (YES or NO)	YES
Operating temperature. max (°C)	120
Operating temperature. min (°C)	-40

UL Recognized

Wire Range (Group B)(AWG)	22~12
Rated voltage (Group B)(V)	600
Rated current (Group B)(A)	20
Wire Range (Group C)(AWG)	22~12
Rated voltage (Group C)(V)	600
Rated current (Group C)(A)	20
Wire Range (Group D)(AWG)	22~12
Rated voltage (Group D)(V)	600
Rated current (Group D)(A)	5

CUL Recognized

Wire Range (Group B)(AWG)	22~12
Rated voltage (Group B)(V)	600
Rated current (Group B)(A)	20
Wire Range (Group C)(AWG)	22~12
Rated voltage (Group C)(V)	600
Rated current (Group C)(A)	20
Wire Range (Group D)(AWG)	22~12
Rated voltage (Group D)(V)	600
Rated current (Group D)(A)	5

VDE Approval

Wire Range (mm ²)	0.34~2.5
Rated voltage (V)	1000
Rated current (A)	24

Explosion - proof Approvals

Wire Range (mm ²)	0.34~2.5
Rated voltage (V)	1000
Rated current (A)	24



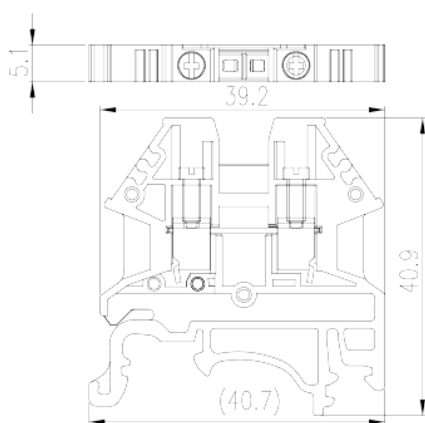

Drawings







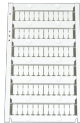

Approvals



Accessories

	<p>DKNSPS-001 Partition Plate For DK2.5N, DK4N, DK2.5N-TN, DK4N-TN, DK10N-TN, DK2.5N-TR, DK4N-TR, DKK2.5N Series, DKK4N Series. Beige color. Using UL94-V0 class of insulation material.</p>
	<p>DKNSPS-005 Partition Plate For DK2.5N, DK4N Beige color. Using UL94-V0 class of insulation material.</p>
	<p>TS-35 DIN-Rail For DP / DK..N / DK.. / AK / DKB / DKU.. /DKM.. series. Material is iron. Length of 1000mm / 2000mm.</p>
	<p>TM47W Marking Label For BEST APPLICATION : DP2.5N, DP2.5N-PE, DP2.5N-TN, DP2.5N-TN-PE, DP2.5N-TR, DP2.5N-TR-PE, DP2.5-3L-SPE, DP2.5-T Series, AK2.5, AK2.5-PE, AK2.5-TN, AK2.5-TN-PE, AK2.5-TR, AK2.5-TR-PE, AK2.5-T Series, AK2.5-TN-T Series, AK2.5-TR-T Series, DK2.5N, DK2.5N-PE, DK2.5N-TN, DK2.5N-TR, DK1.5SG Series, DK2.5N-T Series, DKK2.5N, DKK2.5N-PV, DKK2.5N-L2PE, DKK2.5N-PE, DKK2.5N-T Series, DKK2.5N-D Series, DK2.5-PE AVAILABLE APPLICATION : DKES1.5, DK2.5-PE White color. Using UL94-V2 class of insulation material.</p>
	<p>DSS2.5N-XXP Plug-in bridge For DK2.5N, DK2.5N-TN, DK2.5N-TR, DKK2.5N, DKK2.5N-PV, DKK2.5N-L2PE, DKK2.5N-PE, DKK2.5N-TP, DKK2.5N-TG, DKK2.5N-CP Red color. Using UL94-V0 class of insulation material.</p>
	<p>DSS2.5N-6688-XXP</p>

	<p>Plug-in bridge For DK2.5N, DK2.5N-TN, DKK2.5N Series. Red color. Using UL94-V0 class of insulation material.</p>
	<p>CSC-2.5XXPN Insertion Bridge For DK2.5N, DK2.5N-TN, DK2.5N-TR, DKK2.5N Series, DK2.5N-TP, DK2.5N-TG, DK2.5N-CP. Beige color. Using UL94-V0 class of insulation material.</p>
	<p>DK4NC End cover For DK2.5N / DK4N / DK2.5N-TP / DK2.5N-TG / DK2.5N-CP / DK4N-TP / DK4N-TG / DK4N-CP Grey color. Using UL94-V0 class of insulation material.</p>
	<p>0175L1 Lever For DK2.5N 、DK2.5N-TN 、DK2.5N-TR 、DKK2.5N. Orange color. Using UL94-V0 class of insulation material.</p>
	<p>0175-T002 Test plug For DK2.5N, DK2.5N-TN, DK2.5N-TR, DKK2.5N, DKK2.5N-PV. Red color. Using UL94-V0 class of insulation material.</p>
	<p>TM-R200 Continuous Flat Marking Labels</p>