

PROXIMITY SWITCH

Description

The sensors provide excellent results even with difficult-to-detect objects, e.g. small or thin parts, wires or bright metals.

A variety of types cover a wide range of individual requirements and installation situations. Thus, devices are available with N.C. or N.O. functions, with NPN or PNP switching outputs, and cable or plug connection.

The enclosure rating is IP66.

Features

- Easy-to-use and tough
- Wide range of models
- Wide operating voltage range
- Short circuit protected
- Ideal for a variety of applications
- With a metal connector that can be tightened securely and a cord protector
- Enclosure rating of IP66, water-proof and oil-drip proof
- Fast response



Specification

Item	Standard
Differential travel	10% max. of sensing distance
Target	Ferrous metal (The sensing distance decreases with non-ferrous metal.)
Power supply voltage (operating voltage range)	12 ~ 24 VDC. Ripple (p-p): 10% max. (10 ~ 30 VDC)
Current consumption (DC 3-wire)	10 mA max.
Output type	See Product selection
Control output	Load current (See note 1.) 200 mA max. (32 VDC max.) Residual voltage 1 V max. (under load current of 200 mA with cable length of 2 m)
Operation mode (with sensing object approaching)	See Product selection
Protection circuit	Output reverse polarity protection, Power source circuit reverse polarity protection, Surge suppressor, Short-circuit protection
Ambient air temperature	Operating: -40 ϵ to 70 ϵ , Storage: -40 ϵ to 85 ϵ (with no icing or condensation)
Temperature influence (See note 1.)	\pm 10% max. of sensing distance at 23 ϵ within temperature range of -25 ϵ to 70 ϵ \pm 15% max. of sensing distance at 23 ϵ within temperature range of -40 ϵ to 70 ϵ
Ambient humidity	Operating: 35% to 95%, Storage: 35% to 95%
Voltage influence	\pm 1% max. of sensing distance in rated voltage range \pm 15%
Insulation resistance	50 M Ω min. (at 500 VDC) between current carry parts and case
Dielectric strength	1,000 VAC at 50/60 Hz for 1 min between current carry parts and case
Vibration resistance	10 to 55 Hz, 1.5mm double amplitude for 2 hours each in X, Y and Z directions
Shock resistance	1,000 m/s ² , 10 times each in x, Y and Z directions
Standards and listings	IEC60529: IP66, Degree of protection EN60947-5-2: EMC

Note : When using any model at an ambient temperature between -40°C and -25°C and a power voltage between 30 and 32 VDC, use a load current of 100 mA max.,

HIGHLY

D1

Design, specifications are subject to change without notice.

PROXIMITY SWITCH

Product selection

TS < - < < - <
1 2 3 4 5

1. Housing outline

TS: Inductive thread round
S : Inductive square
CS: Inductive thread round connector

2. Dimension of sensing face

TS CS type series

12: diameter 12mm
18: diameter 18mm
30: diameter 30mm

S type series

17: square 17mm x 17mm
18: square 18mm x 18mm
18L: square 18mm x 18mm
25: square 25mm x 25mm
30: square 30mm x 30mm
40: square 40mm x 40mm

3. Sensing distance

Numeral: Sensing distance:
E.g. 02=2 mm, 16=16mm

4. Output stage

N: NPN open collector DC mode
P: PNP open collector DC mode

5. Output function

1: N.O. normally open
2: N.C. normally close

Example: Inductive thread round housing, M12, Sn=5mm, NPN-DC, normally open,
TS12-05N-1 Inductive square 18x18 mm, Sn=5mm, NPN-DC, normally open.
S18-05N-1

Output stage diagram

	NO	NC
PNP	<p>M12 connector Pin Arrangement</p> <p>Terminal 2 of the M12 connector is not used.</p>	<p>M12 connector Pin Arrangement</p> <p>Terminal 4 of the M12 connector is not used.</p>
NPN	<p>M12 connector Pin Arrangement</p> <p>Terminal 2 of the M12 connector is not used.</p>	<p>M12 connector Pin Arrangement</p> <p>Terminal 4 of the M12 connector is not used.</p>

HIGHLY

D2

Design, specifications are subject to change without notice.

PROXIMITY SWITCH

Ordering information

Inductive thread Round metal body type

Appearance					
Item		Shield		Non-Shield	
		Cable type	Connector type	Cable type	Connector type
Output Function Output Stage	NPN NO-output	TS12-02N-1	CS12-02N-1	TS12-05N-1	CS12-05N-1
	NPN NC-output	TS12-02N-2	CS12-02N-2	TS12-05N-2	CS12-05N-2
	PNP NO-output	TS12-02P-1	CS-12-02P-1	TS12-05P-1	CS12-05P-1
	PNP NO-output	TS12-02P-2	CS12-02P-2	TS12-05P-2	CS12-05P-2
Sensing Distance		2 mm ± 10%		5 mm ± 10%	
Setting distance		0 to 1.6 mm		0 to 4.0mm	
Response frequency		1.5KHz			
Standard target		12x12x1mm			
Body Material		Brass Nickel plated			
Circuit Protection		Yes			
Reverse polarity protection of supply voltage		Yes			
Cable length		2 m			
Enclosure Protection		IP 67			

DIMENSIONS

TS12 Shied

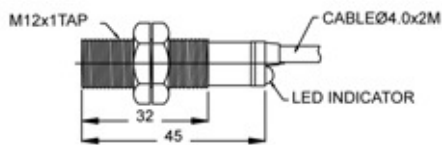

TS12 Non-Shied

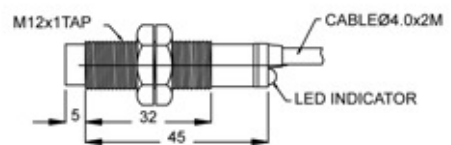

CS12 Shied

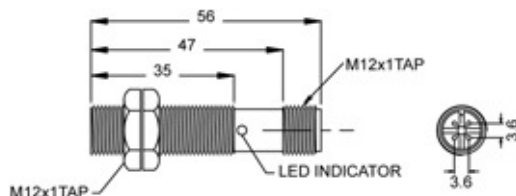

CS12 Non-Shied

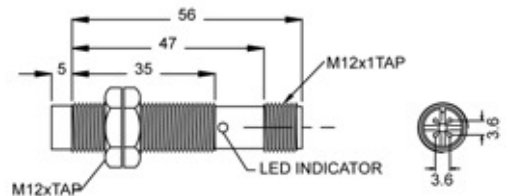

HIGHLY

D3

Design, specifications are subject to change without notice.

PROXIMITY SWITCH

Ordering information

Inductive thread Round metal body type

Appearance					
Item		Shield		Non-Shield	
		Cable type	Connector type	Cable type	Connector type
Output Function Output Stage	NPN NO-output	TS18-05N-1	CS18-05N-1	TS18-08N-1	CS18-08N-1
	NPN NC-output	TS18-05N-2	CS18-05N-2	TS18-08N-2	CS18-08N-2
	PNP NO-output	TS18-05P-1	CS18-05P-1	TS18-08P-1	CS18-08P-1
	PNP NO-output	TS18-05P-2	CS01-05P-2	TS18-08P-2	CS18-08P-2
Sensing Distance		5 mm ± 10%		8 mm ± 10%	
Setting distance		0 to 4.0 mm		0 to 6.4mm	
Response frequency		1.5KHz			
Standard target		18x18x1mm			
Body Material		Brass Nickel plated			
Circuit Protection		Yes			
Reverse polarity protection of supply voltage		Yes			
Cable length		2 m			
Enclosure Protection		IP 67			

DIMENSIONS

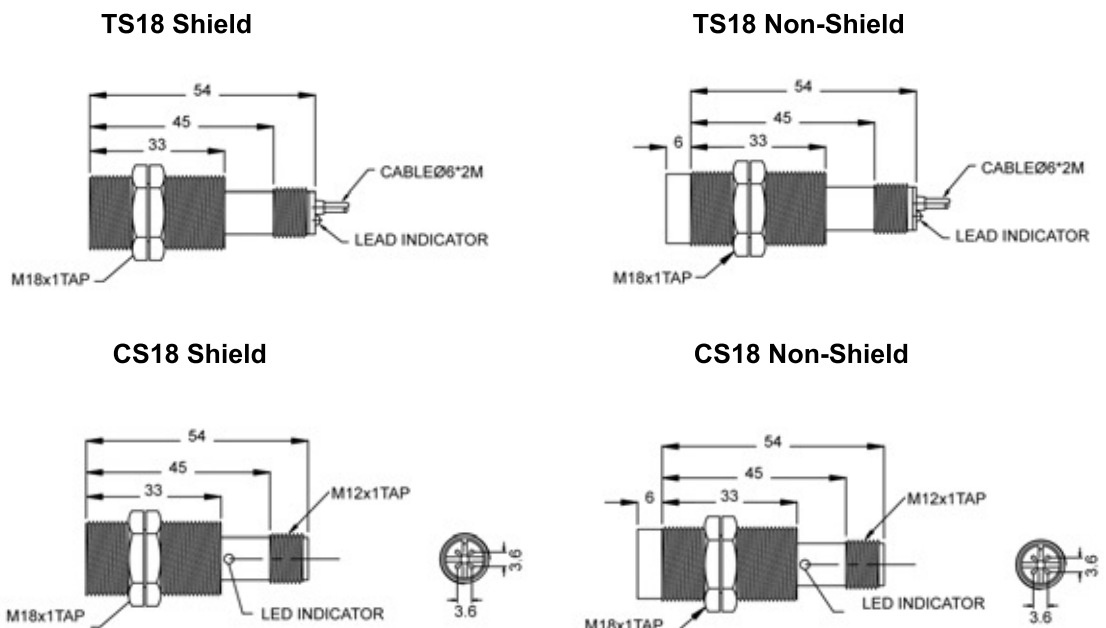

HIGHLY

D4

Design, specifications are subject to change without notice.

PROXIMITY SWITCH

Ordering information

Inductive thread Round metal body type

Appearance					
Item		Shield		Non-Shield	
		Cable type	Connector type	Cable type	Connector type
Output Function Output Stage	NPN NO-output	TS30-10N-1	CS30-10N-1	TS30-15N-1	CS30-15N-1
	NPN NC-output	TS30-10N-2	CS30-10N-2	TS30-15N-2	CS30-15N-2
	PNP NO-output	TS30-10P-1	CS30-10P-1	TS30-15P-1	CS30-15P-1
	PNP NO-output	TS30-10P-2	CS30-10P-2	TS30-15P-2	CS30-15P-2
Sensing Distance		10 mm ± 10%		15 mm ± 10%	
Setting distance		0 to 8.0 mm		0 to 12.0mm	
Response frequency		1.5KHz			
Standard target		30x30x1mm			
Body Material		Brass Nickel plated			
Circuit Protection		Yes			
Reverse polarity protection of supply voltage		Yes			
Cable length		2 m			
Enclosure Protection		IP 67			

DIMENSIONS

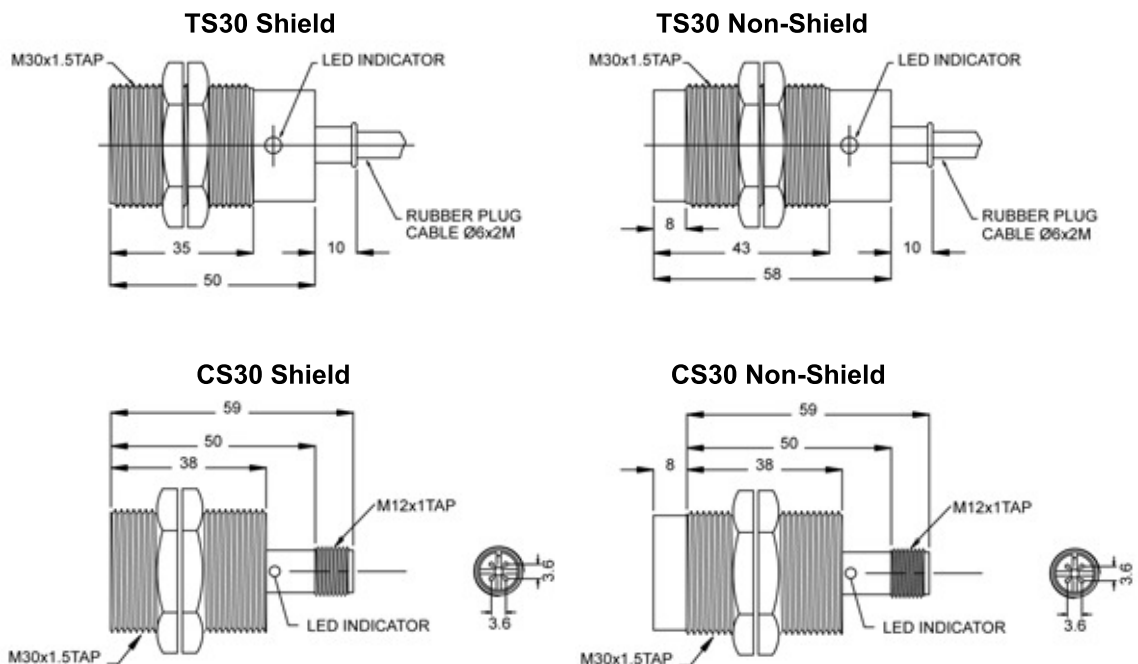

HIGHLY



D5

Design, specifications are subject to change without notice.

PROXIMITY SWITCH

Ordering information

Inductive Square Plastic body type

Appearance			
Item		S17 series	S18 series
Output Function Output Stage	NPN NO-output	S17-05N-1	S18-05N-1
	NPN NC-output	S17-05N-2	S18-05N-2
	PNP NO-output	S17-05P-1	S18-05P-1
	PNP NO-output	S17-05P-2	S18-05P-2
Sensing Distance		5 mm ± 10%	5 mm ± 10%
Setting distance		0 to 4.0 mm	0 to 4.0mm
Response frequency		1.5KHz	
Standard target		17x17x1mm	18x18x1mm
Body Material		Plastic	
Circuit Protection		Yes	
Reverse polarity protection of supply voltage		Yes	
Cable length		2 m	
Enclosure Protection		IP 67	

DIMENSIONS

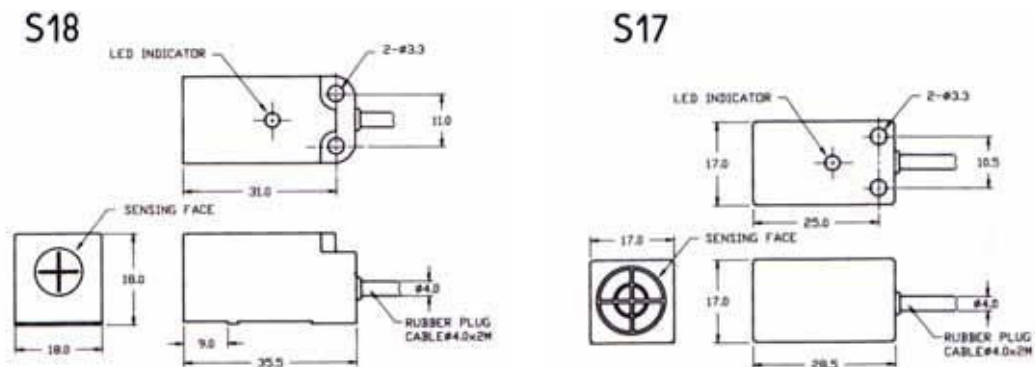





HIGHLY

D6

Design, specifications are subject to change without notice.

PROXIMITY SWITCH

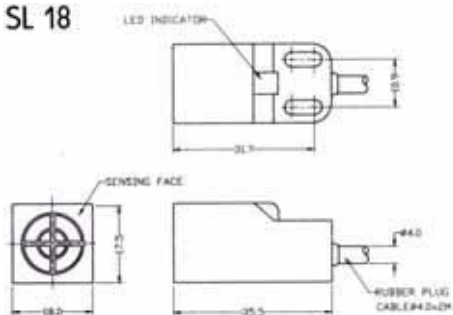
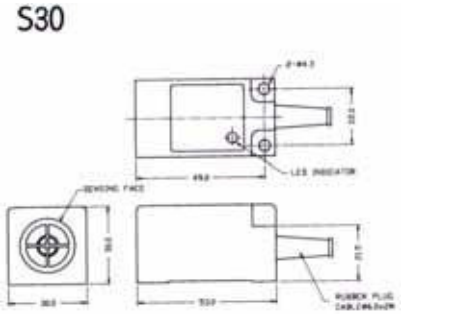
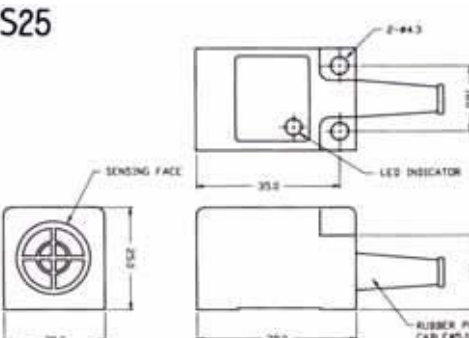
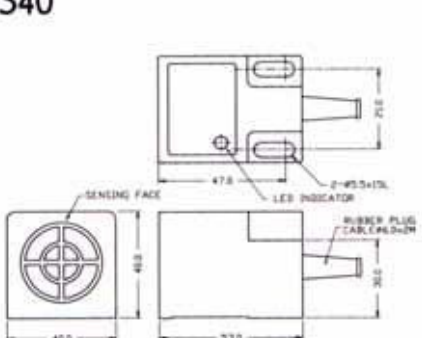
			
SL18 series	S25 series	S30 series	S40 series
SL18-05N-1	S25-07N-1	S30-10N-1	S40-20N-1
SL18-05N-2	S25-07N-2	S30-10N-2	S40-20N-2
SL18-05P-1	S25-07P-1	S30-10P-1	S40-20P-1
SL18-05P-2	S25-07P-2	S30-10P-2	S40-20P-2
5 mm ± 10%	7 mm ± 10%	10 mm ± 10%	20 mm ± 10%
0 to 4.0 mm	0 to 5.6 mm	0 to 8.0mm	0 to 16.0mm
1.5KHz			
18x18x1mm	25x25x1mm	30x30x1mm	40x40x1mm
Plastic			
Yes			
Yes			
2 m			
IP 67			
<p>SL 18</p> 	<p>S30</p> 	<p>S25</p> 	<p>S40</p> 

HIGHLY

D7

Design, specifications are subject to change without notice.

PROXIMITY SWITCH

Technical specifications

Sensing distance: (Sn)

“Sensing distance” refers to the distance at which the proximity switch operates (or releases) as measured, from the reference position (or reference plane) by moving the target in the specified manner.

The item “sensing distance” under “specifications” indicates the value(s) when measured with the standard target.

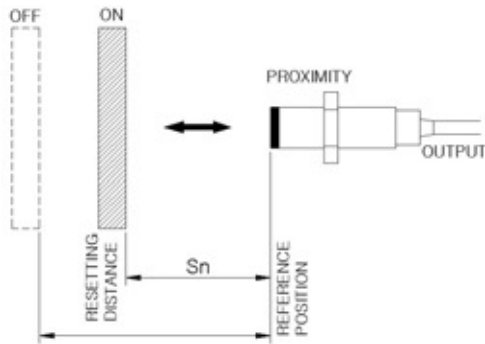

Effective distance:

“Effective distance” refers to the distance from the sensing surface to the passing position of the target which permits the proximity switch to operate without any malfunctions due to temperature or voltage fluctuation.

The item “effective distance” under “specifications” indicates the value(s) when measured with the standard target.

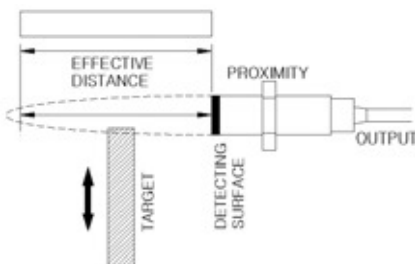

Correction coefficient:

Taking an electrical proximity switch as an example, the sensing distance of the electrical inductance proximity switch is shorter for a non-metal target. In this case, please refer to the following chart for correction of pick-up distance. (But the correction factor has no an absolute value).

For example: Sensing distance of copper: S30-10N-1-P-V

Standard sensing distance: (Sn) x 0.4

(Modulus of copper) = 10 x 0.4 = 4mm

MATERIAL	FACTOR APPROX
MILD STEEL	1.0
ALUMINIUM FOIL	0.95
STAINLESS STEEL	0.7
BRASS	0.4
ALUMINIUM	0.3
COPPER	0.28

Hysteresis: (H)

Proximity switch hysteresis is the max. difference between the switch-ON point (non detection→detection) and the switch-OFF point (detection→non detection) when the target approaches and recedes from the active face (or from its axis). It is quoted in % on switch-ON point. The difference between the two switching distance is intentionally introduced to avoid undesired switching of the proximity when the target is present just within the sensing range.

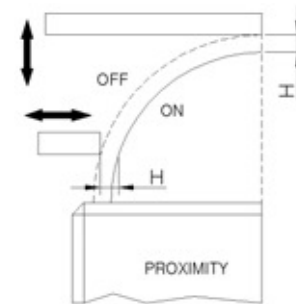

Residual Voltage

Residual voltage refers to the saturated voltage in an output crystal when the proximity switch is “ON”

Current consumption:

Current consumption refers to the maximum current when, under no load condition, it is measured between the power inlet terminal and the output terminal.

Leakage current:

“Leakage current” refers to the frequency of outputs from the proximity switch per second in response to the movement of each target when brought closer to the switch.

The item “switching frequency” under “specifications” indicates the value(s) when measured with the standard target.

HIGHLY

D8

Design, specifications are subject to change without notice.

PROXIMITY SWITCH

Switching frequency: (f)

"Response frequency" refers to the frequency of outputs from the proximity switch per second in response to the movement of each target when brought closer to the switch. The item "switching frequency" under "specifications" indicates the value(s) when measured with the standard target.

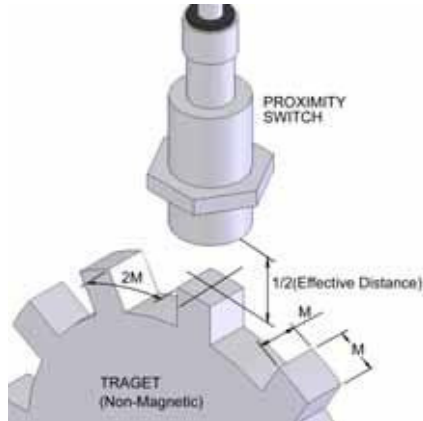

Delay in readiness

The output state of the sensor requires 100ms to become ready after the power has been applied. During this time do not use the sensor output signal.

Environment and temperature effect

It refers to the change of sensing distance of the proximity switch when the environmental temperature changes between (-) 20 to (+) 70 Celsius degrees. The amount of change taken at (+) 23 Celsius degrees shall be regarded as standard sensing distance $S_n \times \pm 10\%$ (change effect distance).

Environment and voltage effect:

It refers to the change of sensing distance of the proximity switch when the applied voltage changes from 10 to 30 VDC or from 24 to 240 VAC. The amount of changes is measured by the sensing distance taken at normal operating voltage $S_n \times \pm 2.5\%$ (change effect distance).

MOUNTING CONDITION

Shield type:

Since the sensing face of the proximity switch is a shield type, it can be buried in an iron or steel materials stockpile to prevent being effected by any surrounding metal objects.

Non shield type:

A space should be provided between the sensing face and the surrounding metals, or the sensing face should protrude to prevent surrounding interference.

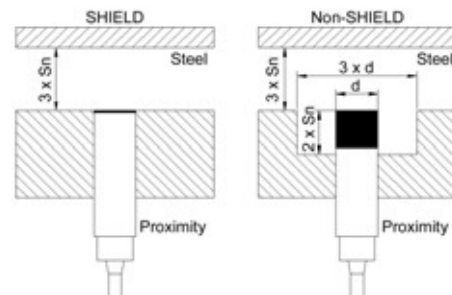

d = Diameter of switch
 S_n = Sensing distance

Mutual interference

A minimum distance must be observed when identical cylindrical rectangular sensors are mounted opposite each other or in parallel.

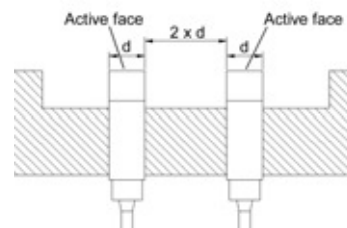

Non-shield mountable sensors mounted parallel.

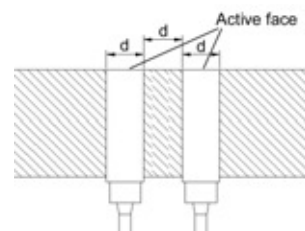

Shield mountable sensors mounted in parallel



Mounted opposite each other

d = Diameter of switch
 S_n = Sensing distance

HIGHLY

D9

Design, specifications are subject to change without notice.

PROXIMITY SWITCH

Applications for sensor's switch

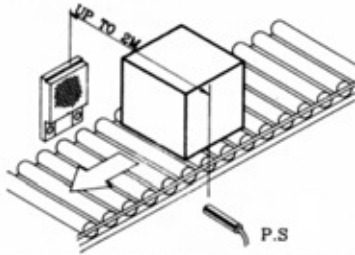

- Detection of luggage
- APPROPRIATE TYPE:
Retro-Reflective Photoelectric Switch

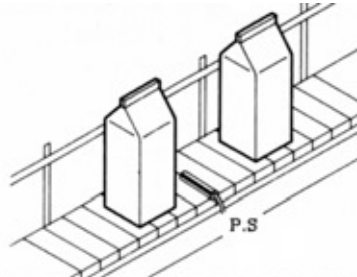

- Counting or detection of MILK Boxes
- APPROPRIATE TYPE:
Diffuse Reflective Photoelectric Switch

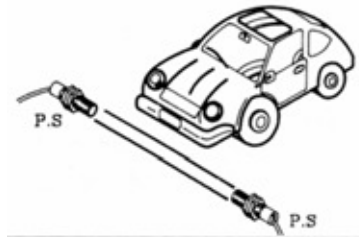

- Detection of presenting cars in parking lot
- APPROPRIATE TYPE:
Thru-Beam Photoelectric Switch

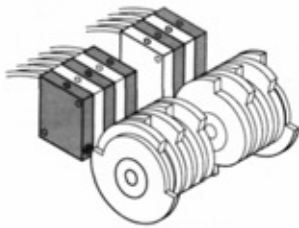

- Mechanical procedure control
- APPROPRIATE TYPE:
Type PS12 Proximity Switch

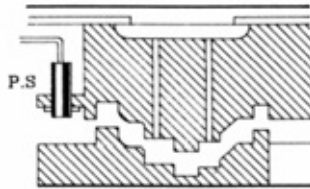

- Confirmation of tooling up-down position
- APPROPRIATE TYPE:
Inductive Proximity Switch

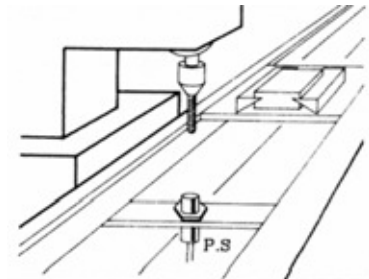

- Positioning of processing parts
- APPROPRIATE TYPE:
Inductive Proximity Switch

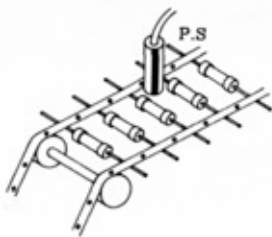

- Detection of resistor
- APPROPRIATE TYPE:
Capacitive Proximity Switch

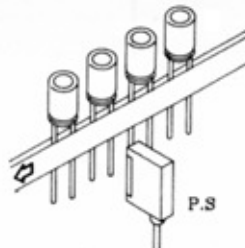

- Detection of electrolytic capacitor
- APPROPRIATE TYPE:
Inductive Proximity Switch

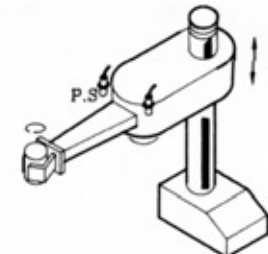

- Positioning of robot arm
- APPROPRIATE TYPE:
Inductive Proximity Switch

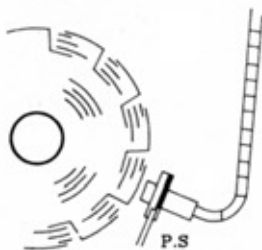

- Detection of wave in high speed rotation
- APPROPRIATE TYPE:
Inductive Proximity Switch

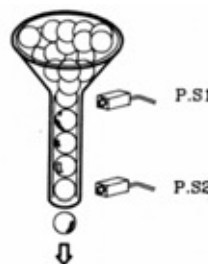

- Detection of steel ball
- APPROPRIATE TYPE:
Inductive Proximity Switch

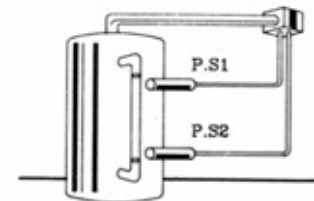

- Detection of powder/liiquid position control
- APPROPRIATE TYPE:
Capacitive Proximity Switch

HIGHLY

D10

Design, specifications are subject to change without notice.