



WF
16-55



● **WF Series**

Part number system

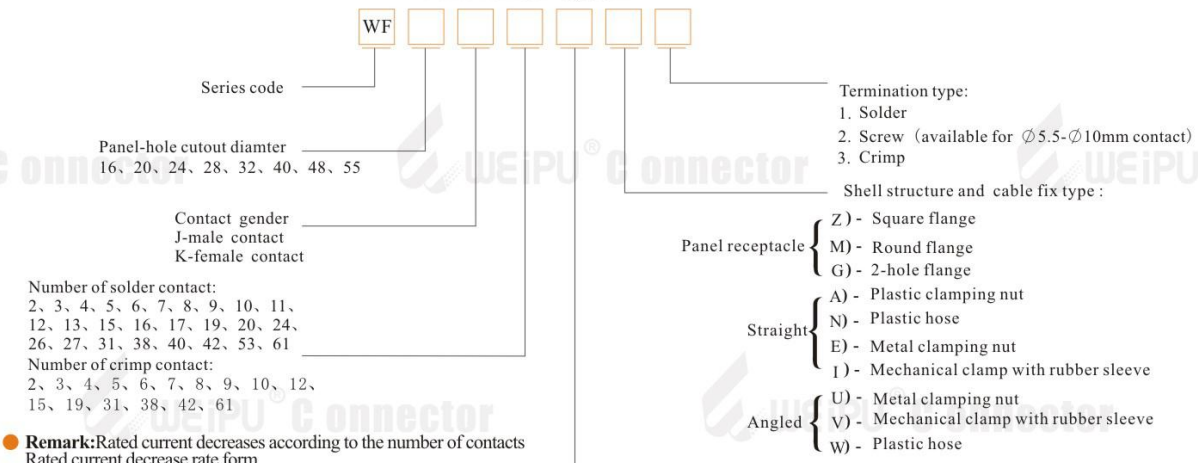

● **Remark:**Rated current decreases according to the number of contacts
Rated current decrease rate form

Number of contact	1-3	4-10	11-20	21-30	31-40	41-50	above 51
Decrease rate %	0	10	20	30	40	50	60

The plugs and receptacles are available with male contact or female contact

Material and spec

Coupling	Threaded coupling
Shell	Zinc alloy with chrome plating
Insert material	PPS max temperature 260 °C , fire resistance: V-0
Contact material	Brass with gold plating
Termination	$\varnothing 1$ - $\varnothing 3.5$ mm Solder, $\varnothing 5.5$ - $\varnothing 10$ mm screw , crimp
Mating cycle	>500
Temperature range	-40°C~+85°C

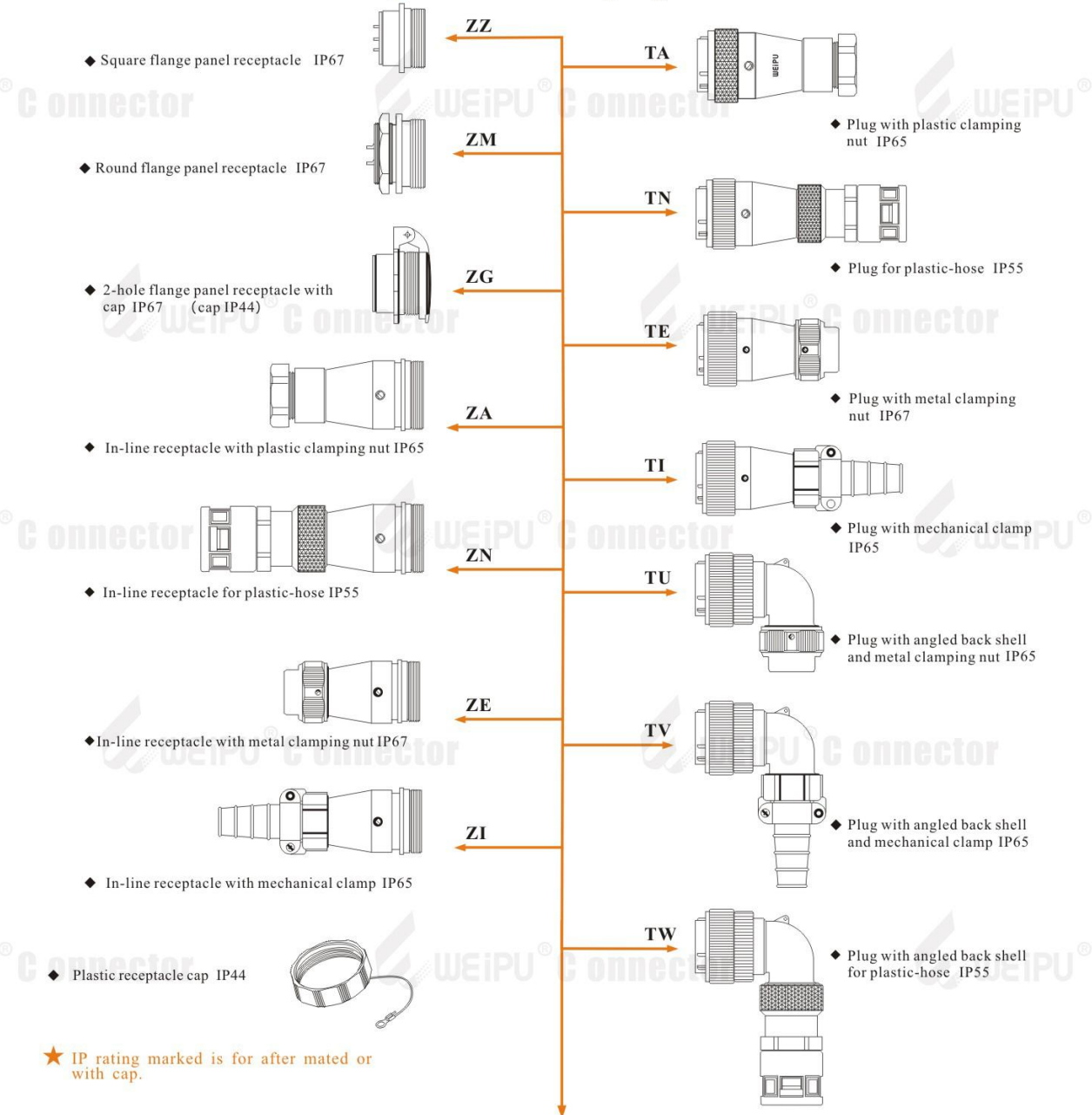
WF Series Mating diagram

★ IP rating marked is for after mated or with cap.

Each side can be male or female contact
 ★ Solder contact arrangement and spec see P47-P48
 ★ Crimp contact arrangement and spec see P49-P52



WF
16-55



● Square flange panel receptacle : ZZ IP67

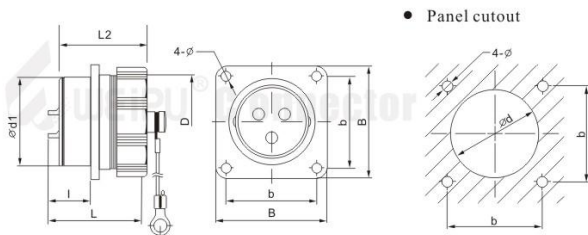

● Panel cutout

★ Solder contact arrangement and spec see P47-P48 ★ Crimp contact arrangement and spec see P49-P52

Dimension mm	WF16	WF20	WF24	WF28	WF32	WF40	WF48	WF55
∅ d1	16	20	24	28	32	40	48	55
D	M18X1	M22X1	M26X1	M30X1	M35X1.5	M44X1.5	M52X1.5	M59X1.5
l	13	14	15	15	18.6	20.5	20.5	20.5
L	26	28	28	28	38.2	39.7	39.7	39.7
b	20	22	26	30	32	40	48	52
B	26	29	32	36	42	50	58	64
∅ d	16.5	20.5	24.5	28.5	32.5	40.5	48.5	55.5
∅	3.5	3.5	3.5	3.5	3.5	4.5	4.5	4.5
L2	22	23	23	23	34	34	34	34

● Round flange panel receptacle: ZM IP67

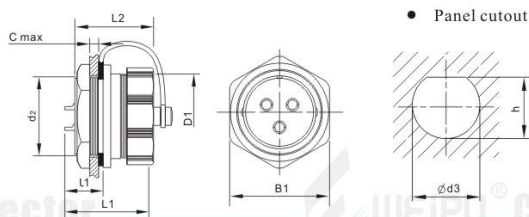

● Panel cutout

Dimension mm	WF16	WF20	WF24	WF28
d2	M16X1	M20X1	M24X1	M28X1
D1	M18X1	M22X1	M26X1	M30X1
C	5	5	5	5
L1	13	14	15	15
L1	26	28	28	28
B1	21	25	29	33
∅ d3	16	20	24	28
h	15.4	19.4	23.2	26.9
L2	22	23	23	23



WF
16-55



- 2-hole flange panel receptacle with cap : ZG IP67(cap IP44)

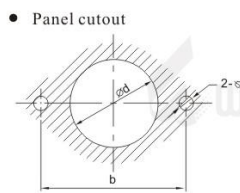
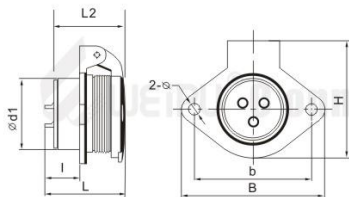

● Panel cutout

★ Solder contact arrangement and spec see P47-P48 ★ Crimp contact arrangement and spec see P49-P52

Dimension/mm	WF16	WF20	WF24	WF28	WF32	WF40	WF48	WF55
∅d1	16	20	24	28	32	40	48	55
∅d	16.5	20.5	24.5	28.5	32.5	40.5	48.5	55.5
I	13	14	15	15	18.1	20.5	20.5	20.5
L	30	32.3	32.3	32.3	42.2	42.2	42.2	43.2
b	30	35	40	45	55	65	80	85
B	38	44	50	55	67	77	92	98
H	32.5	33.5	40.5	45.5	52.5	63.5	74.5	80
∅	3.5	4.5	4.5	4.5	5.5	5.5	5.5	6.5
L2	22	23	23	23	34	34	34	34

- In-line receptacle with plastic clamping nut: ZA IP65

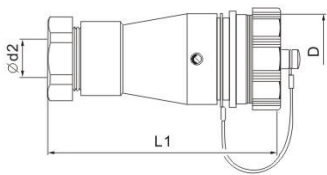

Dimension/mm	WF16	WF20	WF24	WF28	WF32	WF40	WF48	WF55
D	M18X1	M22X1	M26X1	M30X1	M35X1.5	M44X1.5	M52X1.5	M59X1.5
L1	59	68	69	76	92	109	116	110
∅d2	4.5-7	5-12	5-12	6.5-15.5	8.5-19.5	11.5-24.5	11.5-24.5	15-31

- Plug with plastic clamping nut: TA IP65

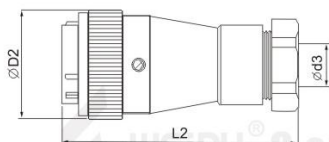

Dimension/mm	WF16	WF20	WF24	WF28	WF32	WF40	WF48	WF55
∅D2	21	25.6	30	33.8	38.2	46.2	55.8	63
L2	54	65	68	73	90	101	102	107
∅d3	4.5-7	5-12	5-12	6.5-15.5	8.5-19.5	11.5-24.5	11.5-24.5	15-31



- In-line receptacle with metal clamping nut: ZE IP67

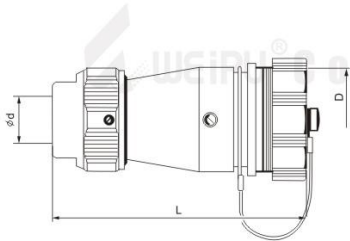

★ Solder contact arrangement and spec see P47-P48
 ★ Crimp contact arrangement and spec see P49-P52

Dimension/mm	WF16	WF20	WF24	WF28	WF32	WF40	WF48	WF55
D	M18X1	M22X1	M26X1	M30X1	M35X1.5	M44X1.5	M52X1.5	M59X1.5
L	53.6	61	67.6	68.2	90.4	103.6	108	131.6
$\varnothing d$	5-6.5	9-10.5	9-10.5	10.5-12.5	15.5-17	18-20	I:18-20 II:24.5-26	24.5-26

- Plug with metal clamping nut: TE IP67

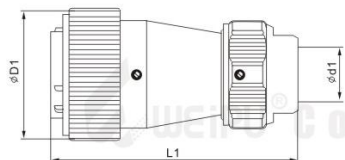

Dimension/mm	WF16	WF20	WF24	WF28	WF32	WF40	WF48	WF55
$\varnothing D1$	21	25.6	30	33.8	38.2	46.2	55.8	63
L1	52.6	61.3	67.3	67.4	88	102.9	107.7	131.6
$\varnothing d1$	5-6.5	9-10.5	9-10.5	10.5-12.5	15.5-17	18-20	I:18-20 II:24.5-26	24.5-26

- Plug with angled back shell and metal clamping nut: TU IP65

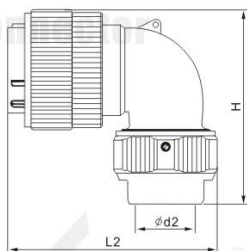

Dimension/mm	WF16	WF20	WF24	WF28	WF32	WF40	WF48	WF55
H	43.2	50.3	54	56.7	74.6	80	98	105.2
L2	47.5	55	58.3	72	82.5	91.5	98.5	109.2
$\varnothing d2$	5-6.5	9-10.5	9-10.5	10.5-12.5	15.5-17	18-20	18-20	24.5-26



- In-line receptacle with mechanical clamp : ZI IP65

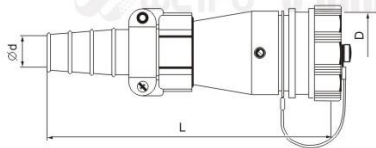

★ Solder contact arrangement and spec see P47-P48
 ★ Crimp contact arrangement and spec see P49-P52

Dimension mm	WF16	WF20	WF24	WF28	WF32	WF40	WF48	WF55
D	M18X1	M22X1	M26X1	M30X1	M35X1.5	M44X1.5	M52X1.5	M59X1.5
L	73	85.7	92	101	118.6	130.2	137	210.5
∅d	7-8	8-10.5	8-10.5	11.5-13.6	13-15.6	15.5-18.8	I:15-18.8 II:24-28	24-28

- Plug with mechanical clamp: TI IP65

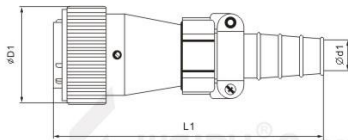

Dimension mm	WF16	WF20	WF24	WF28	WF32	WF40	WF48	WF55
∅D1	21	25.6	30	33.8	38.2	46.2	55.8	63
L1	72.3	86.9	92.5	100.6	118.3	130.4	137.2	161.1
∅d1	7-8	8-10.5	8-10.5	11.5-13.6	13-15.6	15.5-18.8	I:15-18.8 II:24-28	24-28

- Plug with angled back shell and mechanical clamp: TV IP65

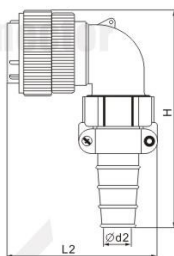

Dimension mm	WF16	WF20	WF24	WF28	WF32	WF40	WF48	WF55
H	60	80	80	93	107	118	127	140
L2	45.5	53	56.3	70	80.5	89.5	98	107.2
∅d2	7-8	8-10.5	8-10.5	11.5-13.6	13-15.6	15.5-18.8	15.5-18.8	24-28



● In-line receptacle for plastic-hose: ZN IP55

★ Solder contact arrangement and spec see P47-P48
 ★ Crimp contact arrangement and spec see P49-P52

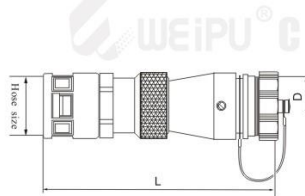

Dimension/mm	WF16	WF20	WF24	WF28	WF32	WF40	WF48	WF55
D	M18X1	M22X1	M26X1	M30X1	M35X1.5	M44X1.5	M52X1.5	M59X1.5
L	80	90	97	104	126.7	134	141	160
Adapter size	PG7	PG11	PG11	PG16	PG21	PG29	I: PG29 II: PG36	PG36
Hose size	1/4"	3/8"	3/8"	1/2"	3/4"	1"	I: 1" II: 1 1/4"	1 1/4"

● Plug for plastic-hose: TN IP55

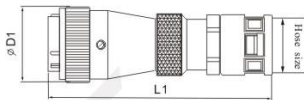

Dimension/mm	WF16	WF20	WF24	WF28	WF32	WF40	WF48	WF55
∅D1	21	25.6	30	33.8	38.2	46.2	55.8	63
L1	63	75	60	63	120	132	138	150
Adapter size	PG7	PG11	PG11	PG16	PG21	PG29	I: PG29 II: PG36	PG36
Hose size	1/4"	3/8"	3/8"	1/2"	3/4"	1"	I: 1" II: 1 1/4"	1 1/4"

● Plug with right angle back shell for plastic-hose: TW IP55

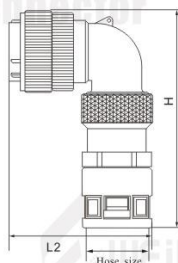

Dimension/mm	WF16	WF20	WF24	WF28	WF32	WF40	WF48	WF55
H	58	78	78	91	105	120	125	132
L2	46.5	54	57.3	71	81.5	90.5	98	108
Adapter size	PG7	PG11	PG11	PG16	PG21	PG29	PG29	PG36
Hose size	1/4"	3/8"	3/8"	1/2"	3/4"	1"	1"	1 1/4"

★ Solder contact arrangement and spec for WS, WF, WY series

WS16、WF16、WY16	2	3	4	5	7	9	10
Male contact face view							
Rated current (A)	10A	10A	5A	5A	5A	5A	5A
Contact diameter	∅1.5X2	∅1.5X3	∅1X4	∅1X5	∅1X7	∅1X9	∅1X10
Rated voltage (AC.V)	500V	500V	500V	500V	400V	400V	400V
Test voltage(AC.V) 1 min	1500V	1500V	1500V	1500V	1200V	1200V	1200V
Contact resistance mΩ	2.5	2.5	5	5	5	5	5
Insulation resistance MΩ	2000	2000	2000	2000	2000	2000	2000
Wire size mm ² /AWG	≤2/14	≤2/14	≤0.785/18	≤0.785/18	≤0.785/18	≤0.785/18	≤0.785/18

WS20、WF20、WY20	2	3	4	5	6	7	9	12
Male contact face view								
Rated current (A)	25A	25A	25A	10A	5A, 30A	10A	5A	5A
Contact diameter	∅2.5X2	∅2.5X3	∅2.5X4	∅1.5X5	∅1X4、∅3X2	∅1.5X7	∅1X9	∅1X12
Rated voltage (AC.V)	500V	500V	500V	500V	500V	500V	500V	400V
Test voltage(AC.V) 1 min	1500V	1500V	1500V	1500V	1500V	1500V	1500V	1200V
Contact resistance mΩ	1	1	1	2.5	5, 1	2.5	5	5
Insulation resistance MΩ	2000	2000	2000	2000	2000	2000	2000	2000
Wire size mm ² /AWG	≤2.5/13	≤2.5/13	≤2.5/13	≤2/14	≤0.785/18 ≤4.17/11	≤2/14	≤0.785/18	≤0.785/18

WS24、WF24、WY24	2	3	4	9	10	12	19
Male contact face view							
Rated current (A)	25A	25A	25A	5A, 25A	10A	10A	5A
Contact diameter	∅2.5X2	∅2.5X3	∅2.5X4	∅1X5、∅2.5X4	∅1.5X10	∅1.5X12	∅1X19
Rated voltage (AC.V)	500V	500V	500V	500V	500V	500V	500V
Test voltage(AC.V) 1 min	1500V	1500V	1500V	1500V	1500V	1500V	1500V
Contact resistance mΩ	1	1	1	5, 1	2.5	2.5	5
Insulation resistance MΩ	2000	2000	2000	2000	2000	2000	2000
Wire size mm ² /AWG	≤2.5/13	≤2.5/13	≤2.5/13	≤0.785/18 ≤2.5/13	≤2/14	≤2/14	≤0.785/18

WS28、WF28、WY28	2	3	4	7	12	16	17	20	24	26
Male contact face view										
Rated current (A)	25A	50A	25A	25A	10A	10A	10A	5A	5A	5A
Contact diameter	∅2.5X2	∅3.5X3	∅2.5X4	∅2.5X7	∅1.5X12	∅1.5X16	∅1.5X17	∅1X20	∅1X24	∅1X26
Rated voltage (AC.V)	500V	500V	500V	500V	500V	500V	500V	400V	400V	400V
Test voltage(AC.V) 1 min	2000V	1500V	1500V	1500V	1500V	1500V	1500V	1200V	1200V	1200V
Contact resistance mΩ	1	0.5	1	1	2.5	2.5	2.5	5	5	5
Insulation resistance MΩ	2000	2000	2000	2000	2000	2000	2000	2000	2000	2000
Wire size mm ² /AWG	≤2.5/13	≤6/9	≤2.5/13	≤2.5/13	≤2/14	≤2/14	≤2/14	≤0.785/18	≤0.785/18	≤0.785/18

★ Solder contact arrangement and spec for WS, WF, WY series

WS32、WF32、WY32	4	6	8	10	10B	11	12	13	19
Male contact face view									
Rated current (A)	50A	10A、25A	10A、50A	10A、25A	25A	25A	25A	10A、25A	10A
Contact diameter	∅ 3.5X4	∅ 1.5X2 ∅ 3.5X4	∅ 1.5X5 ∅ 3.5X3	∅ 1.5X5 ∅ 2.5X5	∅ 2.5X10	∅ 2.5X11	∅ 2.5X12	∅ 1.5X9 ∅ 2.5X4	∅ 1.5X19
Rated voltage (AC.V)	500V	500V	500V	500V	500V	500V	500V	500V	500V
Test voltage(AC.V) 1 min	1500V	1500V	1500V	1500V	1500V	1500V	1500V	1500V	1500V
Contact resistance mΩ	0.5	2.5、0.5	2.5、0.5	2.5、1	1	1	1	2.5、1	2.5
Insulation resistance MΩ	2000	2000	2000	2000	2000	2000	2000	2000	2000
Wire size mm ² /AWG	≤6/9	≤2/14 ≤2.5/13	≤2/14 ≤2.5/13	≤2/14 ≤2.5/13	≤2.5/13	≤2.5/13	≤2.5/13	≤2/14 ≤2.5/13	≤2/14

WS40、WF40、WY40	5	9	15	26	31
Male contact face view					
Rated current (A)	50A	25A、50A	10A	10A、25A	10A
Contact diameter	∅ 3.5X5	∅ 2.5X5 ∅ 3.5X4	∅ 1.5X15	∅ 1.5X22 ∅ 2.5X4	∅ 1.5X31
Rated voltage (AC.V)	500V	500V	500V	500V	500V
Test voltage(AC.V) 1 min	1500V	1500V	1500V	1500V	1500V
Contact resistance mΩ	0.5	1、0.5	2.5	2.5、1	2.5
Insulation resistance MΩ	2000	2000	2000	2000	2000
Wire size mm ² /AWG	≤6/9	≤2.5/13 ≤6/9	≤2/14	≤2/14 ≤2.5/13	≤2/14





WS48、WF48、WY48	5	7	20	27	38	42
Male contact face view						
Rated current (A)	100A	50A	25A	10A、25A	10A、25A	10A
Contact diameter	∅ 5.5X5	∅ 3.5X7	∅ 2.5X20	∅ 1.5X26 ∅ 2.5X1	∅ 1.5X33 ∅ 2.5X5	∅ 1.5X42
Rated voltage (AC.V)	500V	500V	500V	500V	500V	500V
Test voltage(AC.V) 1 min	1500V	1500V	1500V	1500V	1500V	1500V
Contact resistance mΩ	0.3	0.5	1	2.5、1	2.5、1	2.5
Insulation resistance MΩ	2000	2000	2000	2000	2000	2000
Wire size mm ² /AWG	≤16/5	≤6/9	≤2.5/13	≤2/14 ≤2.5/13	≤2/14 ≤2.5/13	≤2/14

WS55、WF55、WY55	4	7	40	53	61
Male contact face view					
Rated current (A)	50A、150A	50A、100A	10A、25A	10A、25A	10A
Contact diameter	∅ 3.5X1 ∅ 10X3	∅ 3.5X1 ∅ 5.5X6	∅ 1.5X25 ∅ 2.5X15	∅ 1.5X48 ∅ 2.5X5	∅ 1.5X61
Rated voltage (AC.V)	500V	500V	500V	500V	500V
Test voltage(AC.V) 1 min	1500V	1500V	1500V	1500V	1500V
Contact resistance mΩ	0.5、0.2	0.5、0.3	2.5、1	2.5、1	2.5
Insulation resistance MΩ	2000	2000	2000	2000	2000
Wire size mm ² /AWG	≤6/9 ≤35/2	≤6/9 ≤16/5	≤2/14 ≤2.5/13	≤2/14 ≤2.5/13	≤2/14

★ Crimp contact arrangement and spec for WS,WF,WY,WP,SP,SY series





WS16、WF16、WY16 SP17、SY17	2	3	4
Male contact face view			
Rated current (A)	10A	10A	5A
Contact diameter	∅ 1.5X2	∅ 1.5X3	∅ 1X4
Rated voltage (AC.V)	500V	500V	500V
Test voltage(AC.V) 1 min	1500V	1500V	1500V
Contact resistance mΩ	2.5	2.5	5
Insulation resistance mΩ	2000	2000	2000

WS20、WF20、WY20、WP20 SP21、SY21	2	3	5	7	8
Male contact face view					
Rated current (A)	25A	25A	10A	10A	5A
Contact diameter	∅ 2.5X2	∅ 2.5X3	∅ 1.5X5	∅ 1.5X7	∅ 1X8
Rated voltage (AC.V)	500V	500V	500V	500V	500V
Test voltage(AC.V) 1 min	1500V	1500V	1500V	1500V	1500V
Contact resistance mΩ	1	1	2.5	2.5	5
Insulation resistance mΩ	2000	2000	2000	2000	2000

WS24、WF24、WY24	4	5	9	12
Male contact face view				
Rated current (A)	25A	25A	10A	5A
Contact diameter	∅ 2.5X4	∅ 2.5X5	∅ 1.5X9	∅ 1X12
Rated voltage (AC.V)	500V	500V	500V	500V
Test voltage(AC.V) 1 min	1500V	1500V	1500V	1500V
Contact resistance mΩ	1	1	2.5	5
Insulation resistance mΩ	2000	2000	2000	2000

WS28、WF28、WY28	7	12	15	19
Male contact face view				
Rated current (A)	25A	10A	5A	5A
Contact diameter	∅ 2.5X7	∅ 1.5X12	∅ 1X15	∅ 1X19
Rated voltage (AC.V)	500V	500V	400V	400V
Test voltage(AC.V) 1 min	1500V	1500V	1200V	1200V
Contact resistance mΩ	1	2.5	5	5
Insulation resistance mΩ	2000	2000	2000	2000

★ Crimp contact arrangement and spec for WS,WF,WY series

WS32、WF32、WY32	4	6	10	15	19
Male contact face view					
Rated current (A)	50A	50A、10A	25A	10A	10A
Contact diameter	∅ 3.5X4	∅ 3.5X4 ∅ 1.5X2	∅ 2.5X10	∅ 1.5X15	∅ 1.5X19
Rated voltage (AC.V)	500V	500V	500V	500V	500V
Test voltage(AC.V) 1 min	1500V	1500V	1500V	1500V	1500V
Contact resistance mΩ	2.5	2.5	5	5	5
Insulation resistanceMΩ	2000	2000	2000	2000	2000

WS40、WF40、WY40	5	19	31
Male contact face view			
Rated current (A)	50A	25A	10A
Contact diameter	∅ 3.5X5	∅ 2.5X19	∅ 1.5X31
Rated voltage (AC.V)	500V	500V	500V
Test voltage(AC.V) 1 min	1500V	1500V	1500V
Contact resistance mΩ	1	1	2.5
Insulation resistanceMΩ	2000	2000	2000

WS48、WF48、WY48	31	42
Male contact face view		
Rated current (A)	25A	10A
Contact diameter	∅ 2.5X31	∅ 1.5X42
Rated voltage (AC.V)	500V	500V
Test voltage(AC.V) 1 min	1500V	1500V
Contact resistance mΩ	1	2.5
Insulation resistanceMΩ	2000	2000

WS55、WF55、WY55	38	61
Male contact face view		
Rated current (A)	25A	10A
Contact diameter	∅ 2.5X38	∅ 1.5X61
Rated voltage (AC.V)	500V	500V
Test voltage(AC.V) 1 min	1500V	1500V
Contact resistance mΩ	1	2.5
Insulation resistanceMΩ	2000	2000