

**C30043**  
G=19,05 kg/m, P=72,03 cm<sup>2</sup>, O=232,75 cm

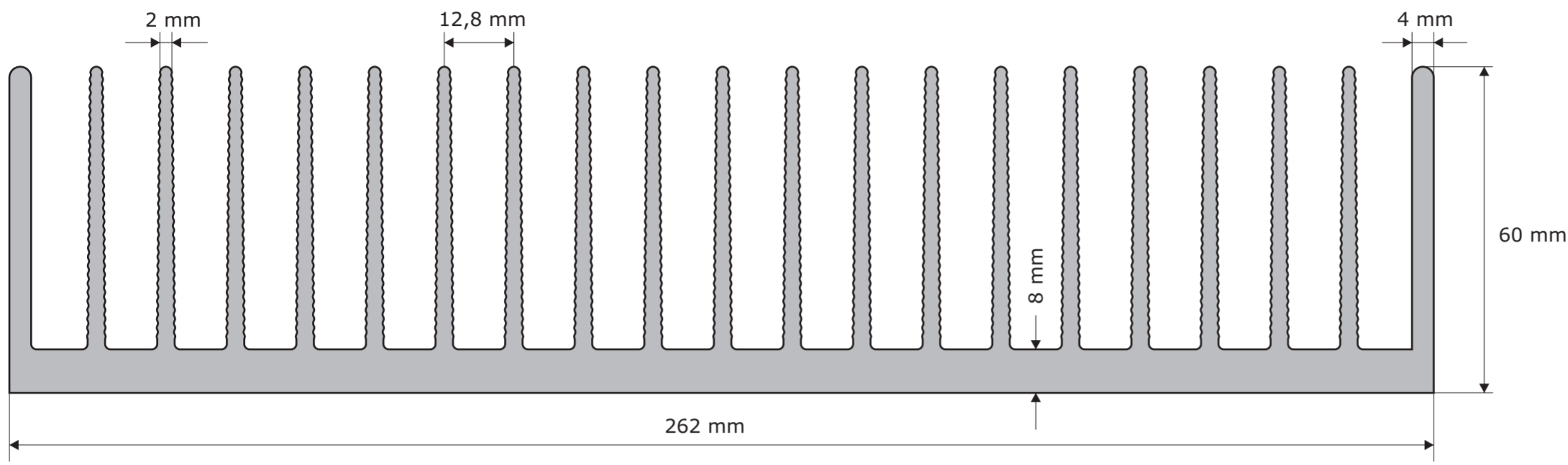

**C26260**  
G=12,64 kg/m, P=51,84 cm<sup>2</sup>, O=275,81 cm

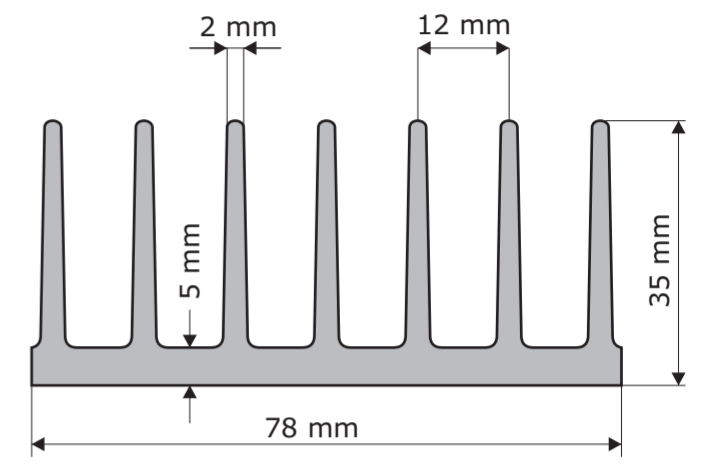

**A5723**  
G=2,5 kg/m, P=9,65 cm<sup>2</sup>, O=56,46 cm

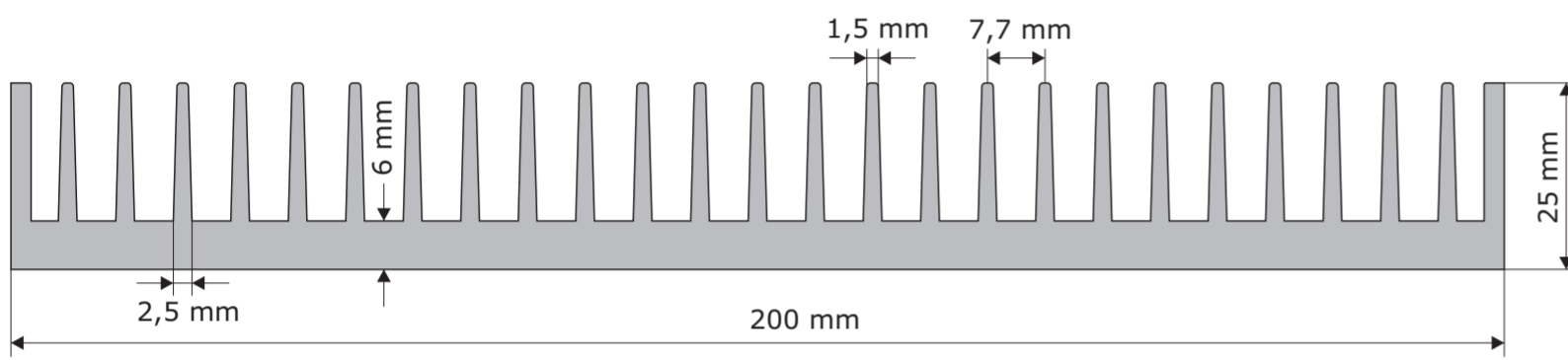

**C20025**  
G=6,15 kg/m, P=23,22 cm<sup>2</sup>, O=137,71 cm

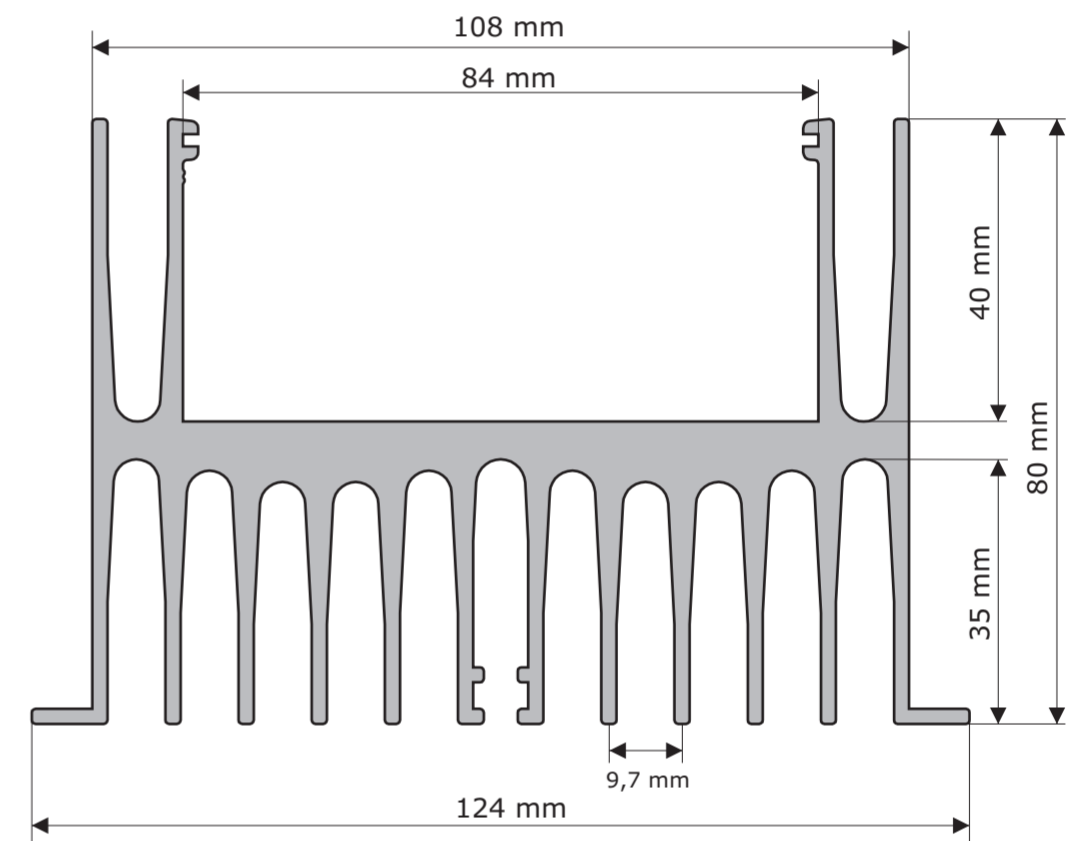

**P4357**  
G=5,65 kg/m, P=21,82 cm<sup>2</sup>, O=134,31 cm

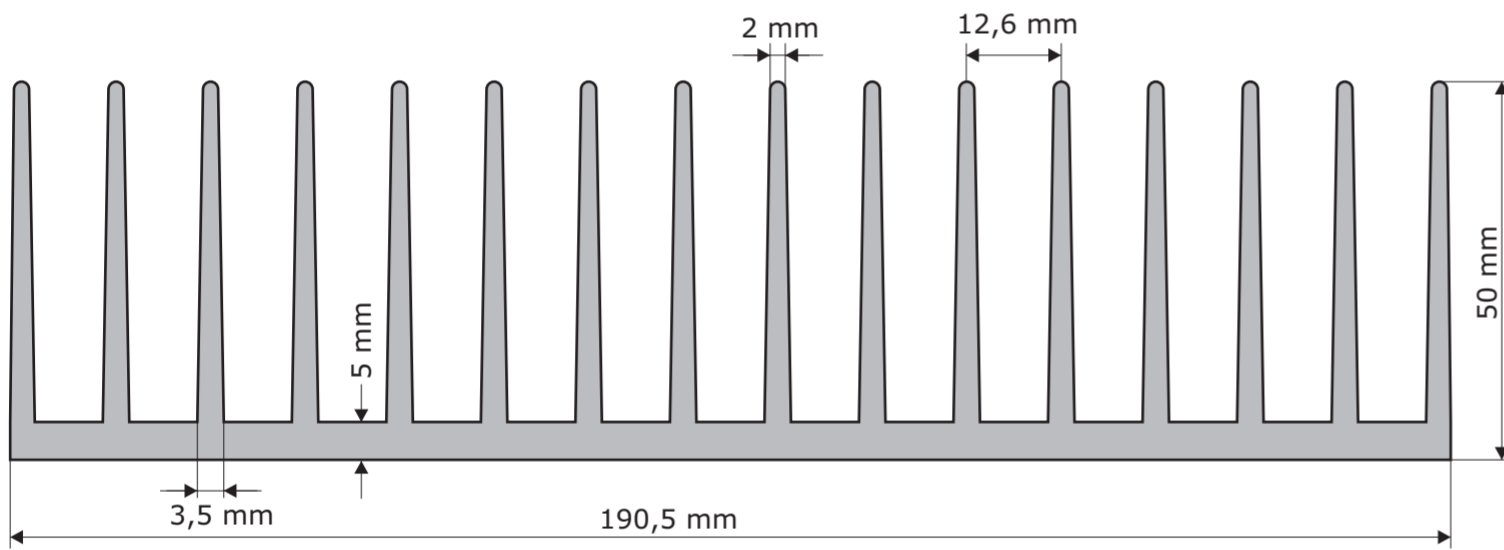

**A6023**  
G=8,19 kg/m, P=29,03 cm<sup>2</sup>, O=179,4 cm

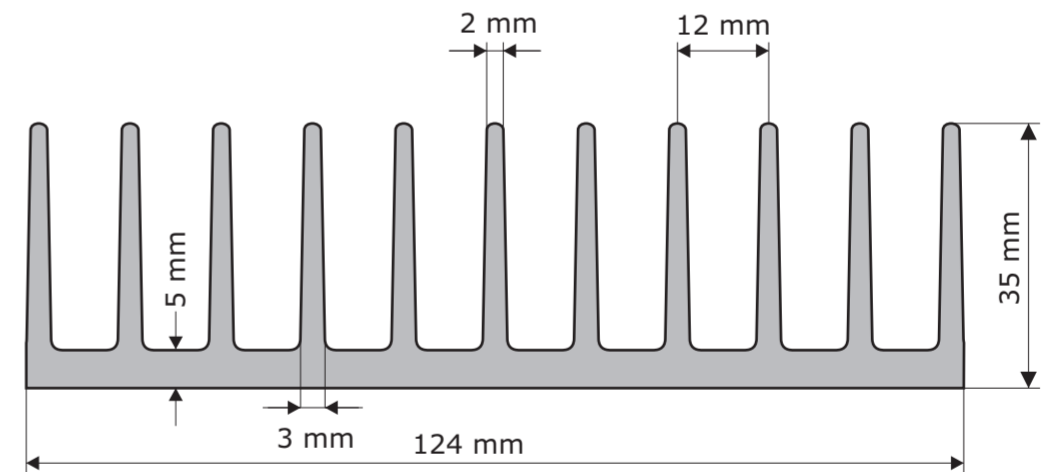

**A5724**  
G=4,06 kg/m, P=15,25 cm<sup>2</sup>, O=88,52 cm

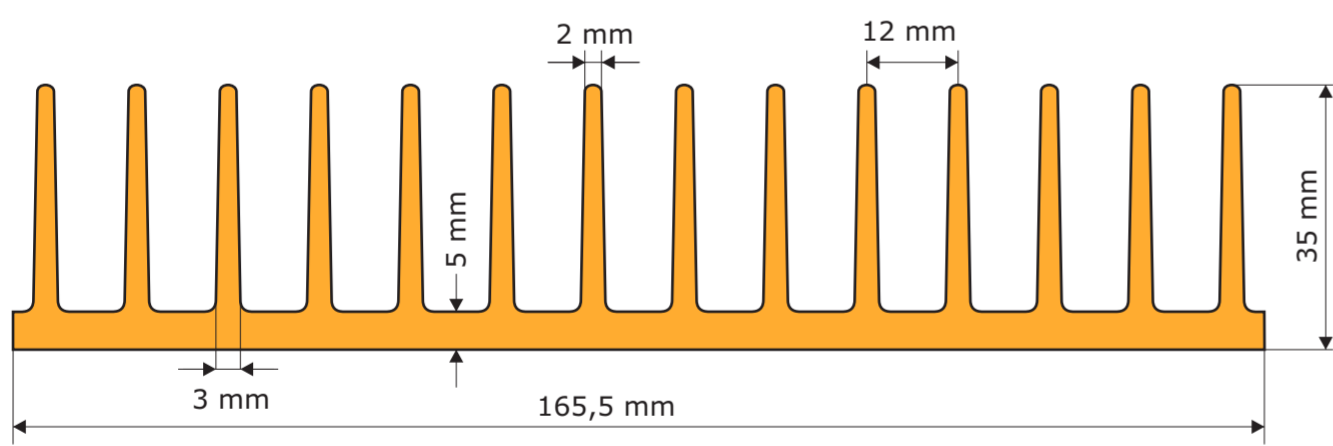

**A4291**  
G=5,09 kg/m, P=19,8 cm<sup>2</sup>, O=113,78 cm

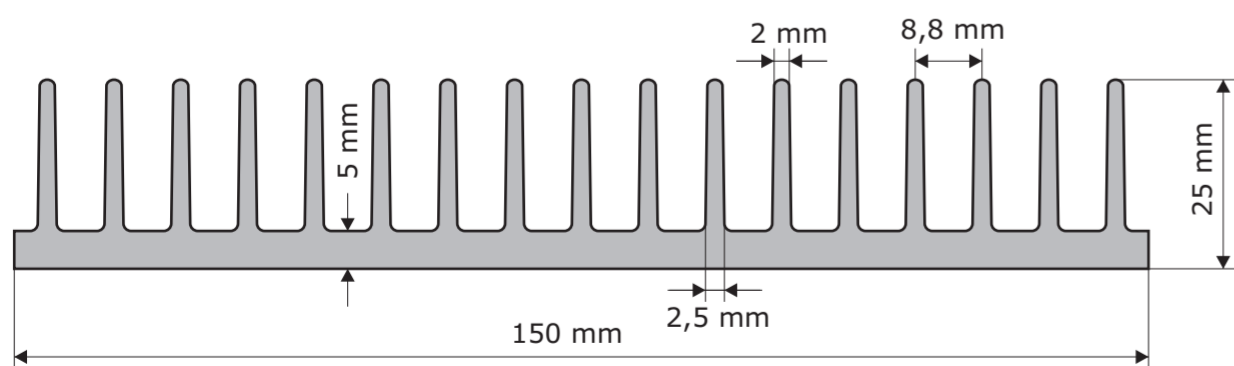

**P52317**  
G=4,1 kg/m, P=15,17 cm<sup>2</sup>, O=95,37 cm

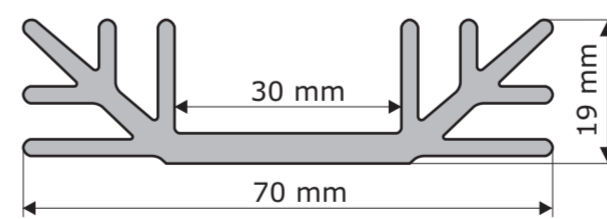

**A4463**  
G=1,28 kg/m  
P=4,77 cm<sup>2</sup>  
O=33,4 cm

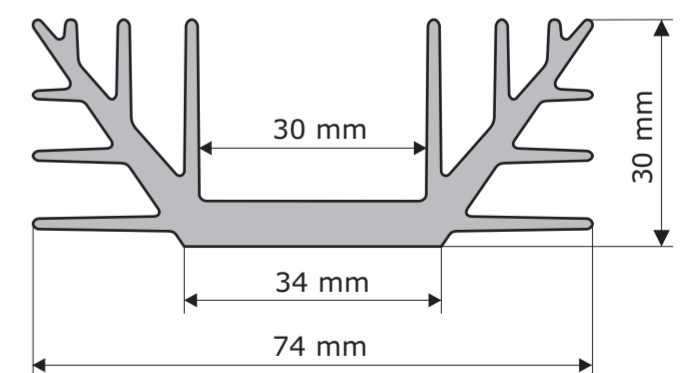

**A4240**  
G=1,93 kg/m, P=6,73 cm<sup>2</sup>, O=46,44 cm

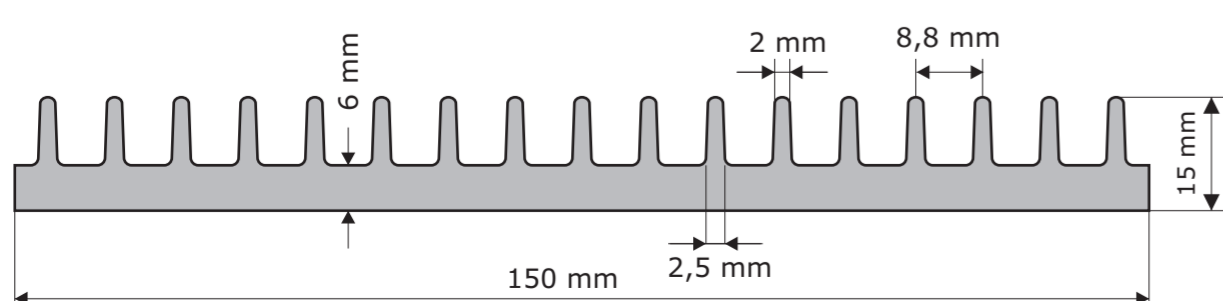

**P3698**  
G=3,4 kg/m, P=12,46 cm<sup>2</sup>, O=58,18 cm

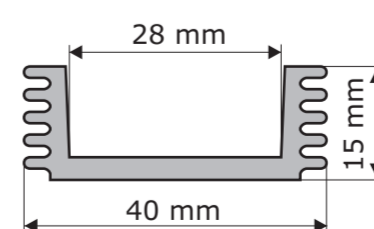

**A4755**  
G=0,58 kg/m  
P=2,07 cm<sup>2</sup>  
O=17,55 cm

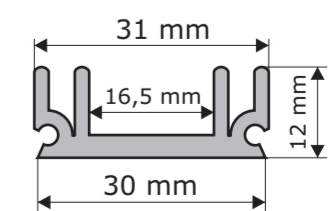

**P22139**  
G=0,44 kg/m  
P=1,59 cm<sup>2</sup>  
O=14,37 cm