

1 2 3 4 5 6

A

B

C

D

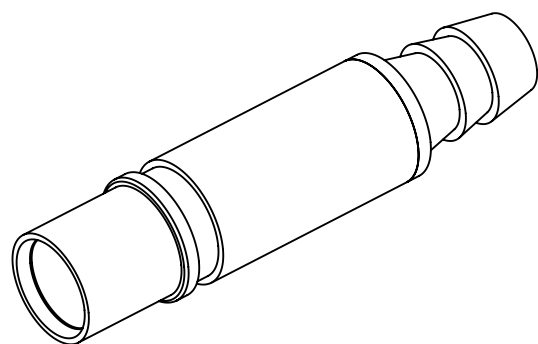
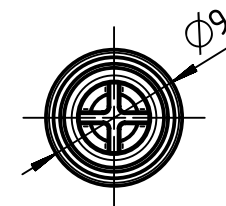
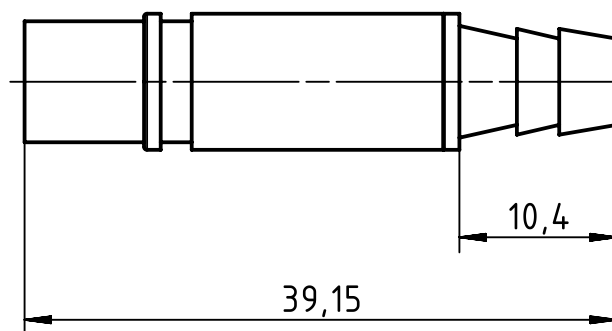

	All rights reserved Department EL PD - DE	All Dimensions in mm Original Size DIN A4		Scale 2:1	Free size tol.		Ref.	
		HARTING Electric GmbH & Co. KG D-32339 Espelkamp		Created by MOELLERLI	Inspected by BEISCHER	Standardisation TIEMANNA	Date 2016-09-08	State Final Release
Title Pneum. contact metal OD6mm female+valve							Doc-Key / ECM-Nr. 100657911/UGD/001/C 500000108675	
Type TB				Number 09 14 000 6416			Rev. C	Page 1/1