

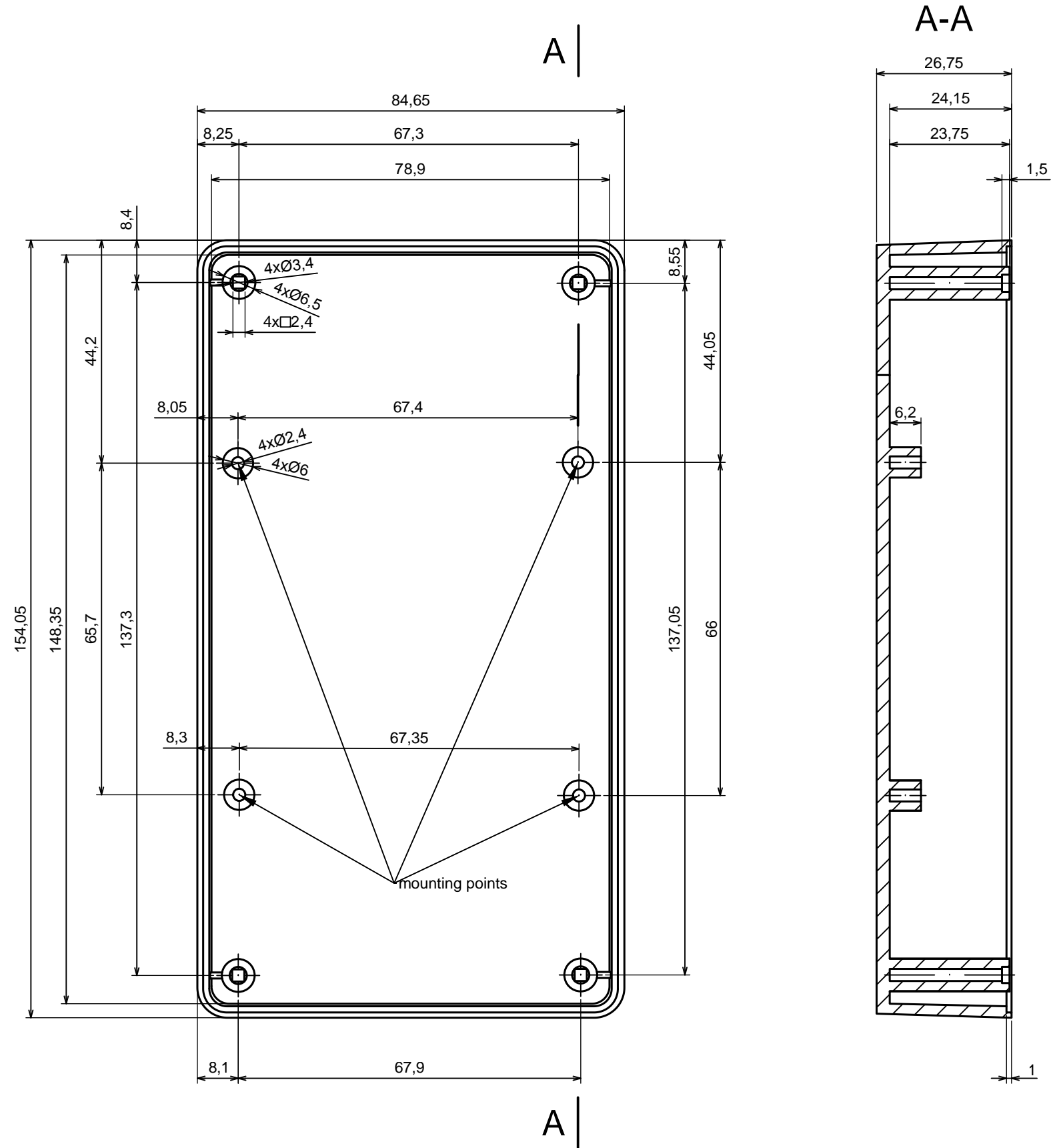

All rights reserved, Copyright Kradex 2016		
Product model	Enclosure Z78 - assembly	
Format: A3	Material: PS, ABS	
Scale 1:1	Tolerance: +/- 0.5	



All rights reserved, Copyright Kradox 2016		
Product model	Enclosure Z78 - base	
Format: A3	Material: PS, ABS	
Scale 1:1	Tolerance: +/- 0.5	

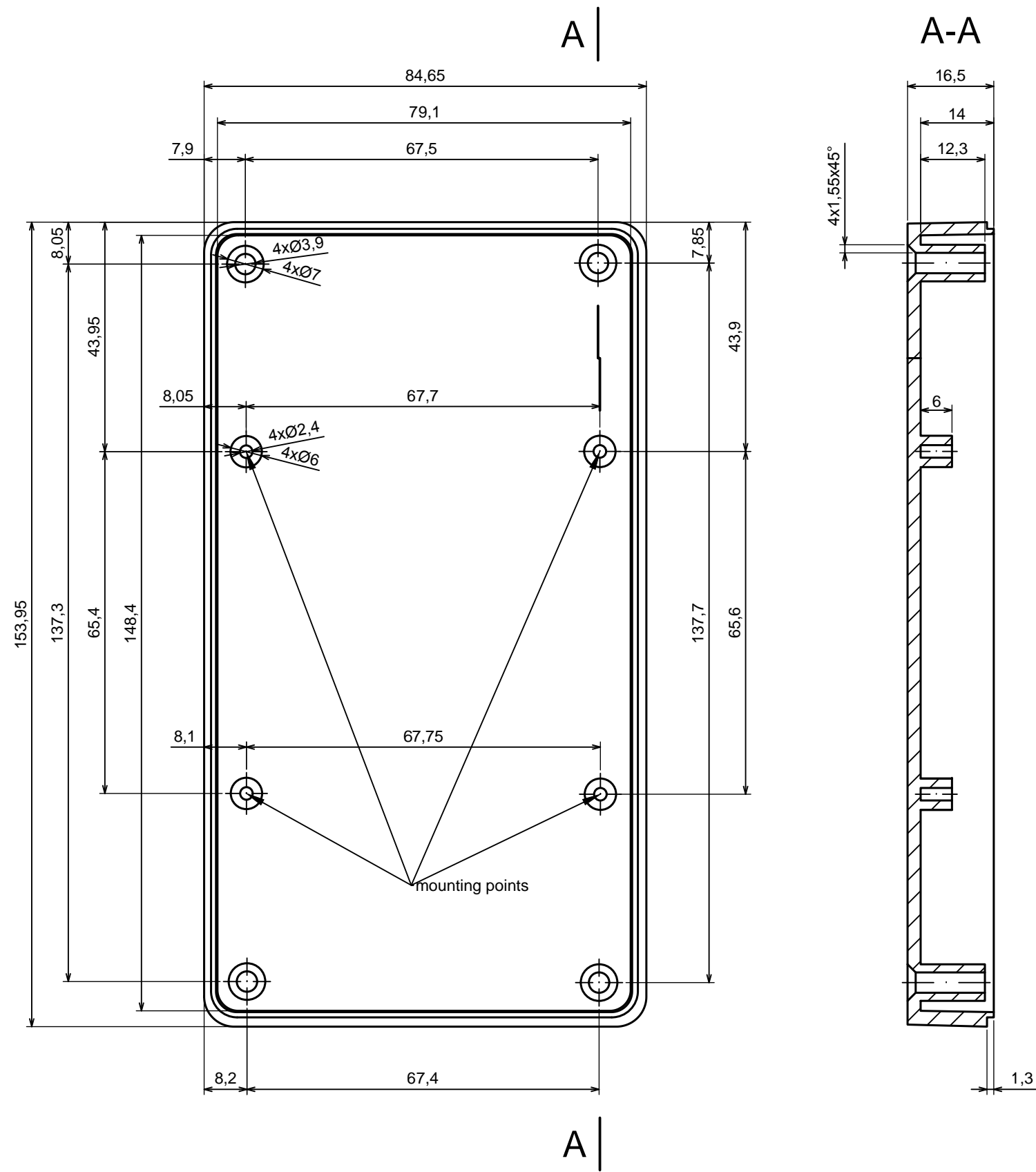

All rights reserved, Copyright Kradox 2016	
Product model	Enclosure Z78- cover
Format: A3	Material: PS, ABS
Scale 1:1	Tolerance: +/- 0.5

