

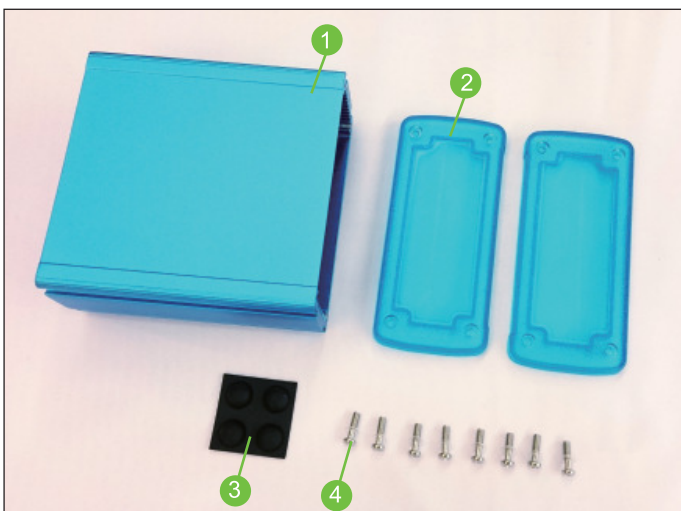











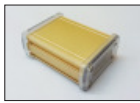
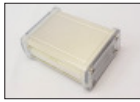



PRODUCT INFORMATION











- Material of the aluminium body : Aluminium alloy 6063
- Material of the plastic end panel : UL94-V0 rating of polycarbonate
- Color of the aluminium body : Golden <GD> , Silver <SR> , Red <RD> , Blue <BU> & Black <BK> anodized finish
- Color of the plastic end panel : Clear, Infra-red , Translucent blue & black

Content



- 1: Aluminium body
- 2: Plastic end panel
- 3: Rubber feet
- 4: Stainless screw and Polycarbonate washer

※ Reference Product Photo	Item number	COLOR		External Dimension (mm)
		Extruded Aluminium Body	Plastic end Panels	
	ALUG702GD040-C	■ Golden	□ Clear	68.7 x 35.2 x 49
	※ ALUG702GD080-C	■ Golden	□ Clear	68.7 x 35.2 x 89
	ALUG702GD120-C	■ Golden	□ Clear	68.7 x 35.2 x 129
	ALUG702SR040-C	■ Silver	□ Clear	68.7 x 35.2 x 49
	※ ALUG702SR080-C	■ Silver	□ Clear	68.7 x 35.2 x 89
	ALUG702SR120-C	■ Silver	□ Clear	68.7 x 35.2 x 129
	ALUG702RD040-IR	■ Red	■ Infra Red	68.7 x 35.2 x 49
	※ ALUG702RD080-IR	■ Red	■ Infra Red	68.7 x 35.2 x 89
	ALUG702RD120-IR	■ Red	■ Infra Red	68.7 x 35.2 x 129
	ALUG702BU040-CBU	■ Blue	■ Translucent Blue	68.7 x 35.2 x 49
	※ ALUG702BU080-CBU	■ Blue	■ Translucent Blue	68.7 x 35.2 x 89
	ALUG702BU120-CBU	■ Blue	■ Translucent Blue	68.7 x 35.2 x 129
	ALUG702BK040-BK	■ Black	■ Black	68.7 x 35.2 x 49
	※ ALUG702BK080-BK	■ Black	■ Black	68.7 x 35.2 x 89
	ALUG702BK120-BK	■ Black	■ Black	68.7 x 35.2 x 129
	ALUG704GD060-C	■ Golden	□ Clear	113.7 x 35.2 x 69
	※ ALUG704GD110-C	■ Golden	□ Clear	113.7 x 35.2 x 119
	ALUG704GD160-C	■ Golden	□ Clear	113.7 x 35.2 x 169
	ALUG704SR060-C	■ Silver	□ Clear	113.7 x 35.2 x 69
	※ ALUG704SR110-C	■ Silver	□ Clear	113.7 x 35.2 x 119
	ALUG704SR160-C	■ Silver	□ Clear	113.7 x 35.2 x 169
	※ ALUG704RD060-IR	■ Red	■ Infra Red	113.7 x 35.2 x 69
	ALUG704RD110-IR	■ Red	■ Infra Red	113.7 x 35.2 x 119
	ALUG704RD160-IR	■ Red	■ Infra Red	113.7 x 35.2 x 169
	ALUG704BU060-CBU	■ Blue	■ Translucent Blue	113.7 x 35.2 x 69
	ALUG704BU110-CBU	■ Blue	■ Translucent Blue	113.7 x 35.2 x 119
	※ ALUG704BU160-CBU	■ Blue	■ Translucent Blue	113.7 x 35.2 x 169
	ALUG704BK060-BK	■ Black	■ Black	113.7 x 35.2 x 69
	※ ALUG704BK110-BK	■ Black	■ Black	113.7 x 35.2 x 119
	ALUG704BK160-BK	■ Black	■ Black	113.7 x 35.2 x 169
	※ ALUG705GD060-C	■ Golden	□ Clear	115.1 x 51.6 x 69
	ALUG705GD110-C	■ Golden	□ Clear	115.1 x 51.6 x 119
	ALUG705GD160-C	■ Golden	□ Clear	115.1 x 51.6 x 169
	ALUG705SR060-C	■ Silver	□ Clear	115.1 x 51.6 x 69
	※ ALUG705SR110-C	■ Silver	□ Clear	115.1 x 51.6 x 119
	ALUG705SR160-C	■ Silver	□ Clear	115.1 x 51.6 x 169
	ALUG705RD060-IR	■ Red	■ Infra Red	115.1 x 51.6 x 69
	ALUG705RD110-IR	■ Red	■ Infra Red	115.1 x 51.6 x 119
	※ ALUG705RD160-IR	■ Red	■ Infra Red	115.1 x 51.6 x 169
	ALUG705BU060-CBU	■ Blue	■ Translucent Blue	115.1 x 51.6 x 69
	※ ALUG705BU110-CBU	■ Blue	■ Translucent Blue	115.1 x 51.6 x 119
	ALUG705BU160-CBU	■ Blue	■ Translucent Blue	115.1 x 51.6 x 169
	ALUG705BK060-BK	■ Black	■ Black	115.1 x 51.6 x 69
	※ ALUG705BK110-BK	■ Black	■ Black	115.1 x 51.6 x 119
	ALUG705BK160-BK	■ Black	■ Black	115.1 x 51.6 x 169

※ Reference Product Photo	Item number	COLOR		External Dimension (mm)
		Extruded Aluminium Body	Plastic end Panels	
	ALUG706GD080-C	■ Golden	□ Clear	146.6 x 41.6 x 89
	※ ALUG706GD120-C	■ Golden	□ Clear	146.6 x 41.6 x 129
	ALUG706GD160-C	■ Golden	□ Clear	146.6 x 41.6 x 169
	ALUG706GD200-C	■ Golden	□ Clear	146.6 x 41.6 x 209
	ALUG706SR080-C	■ Silver	□ Clear	146.6 x 41.6 x 89
	ALUG706SR120-C	■ Silver	□ Clear	146.6 x 41.6 x 129
	※ ALUG706SR160-C	■ Silver	□ Clear	146.6 x 41.6 x 169
	ALUG706SR200-C	■ Silver	□ Clear	146.6 x 41.6 x 209
	ALUG706RD080-IR	■ Red	■ Infra Red	146.6 x 41.6 x 89
	ALUG706RD120-IR	■ Red	■ Infra Red	146.6 x 41.6 x 129
	ALUG706RD160-IR	■ Red	■ Infra Red	146.6 x 41.6 x 169
	※ ALUG706RD200-IR	■ Red	■ Infra Red	146.6 x 41.6 x 209
	ALUG706BU080-CBU	■ Blue	■ Translucent Blue	146.6 x 41.6 x 89
	ALUG706BU120-CBU	■ Blue	■ Translucent Blue	146.6 x 41.6 x 129
	※ ALUG706BU160-CBU	■ Blue	■ Translucent Blue	146.6 x 41.6 x 169
	ALUG706BU200-CBU	■ Blue	■ Translucent Blue	146.6 x 41.6 x 209
	※ ALUG706BK080-BK	■ Black	■ Black	146.6 x 41.6 x 89
	ALUG706BK120-BK	■ Black	■ Black	146.6 x 41.6 x 129
	ALUG706BK160-BK	■ Black	■ Black	146.6 x 41.6 x 169
	ALUG706BK200-BK	■ Black	■ Black	146.6 x 41.6 x 209
	※ ALUG708GD080-C	■ Golden	□ Clear	177.6 x 61.1 x 89
	ALUG708GD120-C	■ Golden	□ Clear	177.6 x 61.1 x 129
	ALUG708GD160-C	■ Golden	□ Clear	177.6 x 61.1 x 169
	ALUG708GD200-C	■ Golden	□ Clear	177.6 x 61.1 x 209
	ALUG708SR080-C	■ Silver	□ Clear	177.6 x 61.1 x 89
	※ ALUG708SR120-C	■ Silver	□ Clear	177.6 x 61.1 x 129
	ALUG708SR160-C	■ Silver	□ Clear	177.6 x 61.1 x 169
	ALUG708SR200-C	■ Silver	□ Clear	177.6 x 61.1 x 209
	ALUG708RD080-IR	■ Red	■ Infra Red	177.6 x 61.1 x 89
	※ ALUG708RD120-IR	■ Red	■ Infra Red	177.6 x 61.1 x 129
	ALUG708RD160-IR	■ Red	■ Infra Red	177.6 x 61.1 x 169
	ALUG708RD200-IR	■ Red	■ Infra Red	177.6 x 61.1 x 209
	ALUG708BU080-CBU	■ Blue	■ Translucent Blue	177.6 x 61.1 x 89
	ALUG708BU120-CBU	■ Blue	■ Translucent Blue	177.6 x 61.1 x 129
	ALUG708BU160-CBU	■ Blue	■ Translucent Blue	177.6 x 61.1 x 169
	※ ALUG708BU200-CBU	■ Blue	■ Translucent Blue	177.6 x 61.1 x 209
	ALUG708BK080-BK	■ Black	■ Black	177.6 x 61.1 x 89
	ALUG708BK120-BK	■ Black	■ Black	177.6 x 61.1 x 129
	※ ALUG708BK160-BK	■ Black	■ Black	177.6 x 61.1 x 169
	ALUG708BK200-BK	■ Black	■ Black	177.6 x 61.1 x 209

Continuous Rubber Seal, Wall Mounting bracket

Continuous Rubber Seal

- Material of the continuous rubber seal : CR (Neoprene)
- Color of the continuous rubber seal : Black

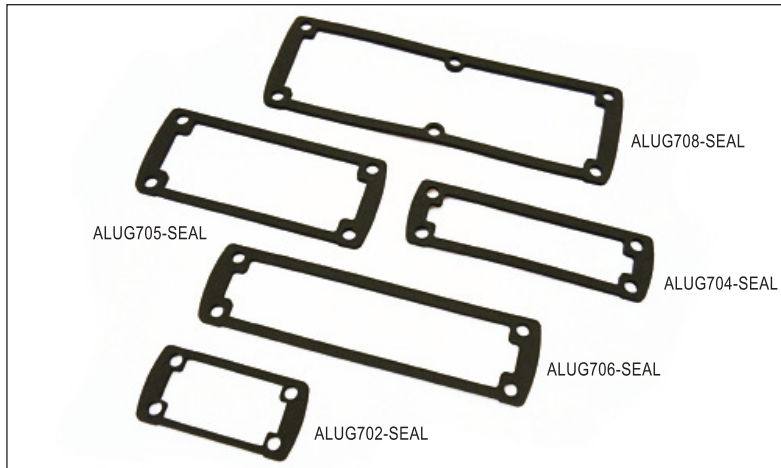

Example

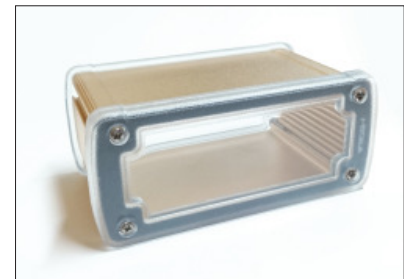
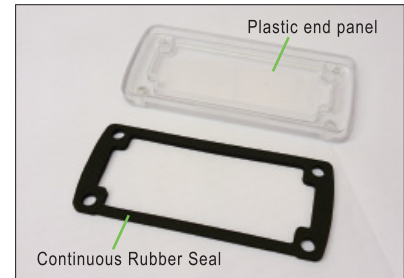

Item Number	Color	External Dimension (mm)
ALUG702-SEAL	Black	64.7 x 31.2 x 3
ALUG704-SEAL	Black	109.7 x 31.2 x 3
ALUG705-SEAL	Black	109.7 x 46.2 x 3
ALUG706-SEAL	Black	141.2 x 36.2 x 3
ALUG708-SEAL	Black	171.2 x 54.7 x 3

Wall Mounting Bracket

- Material of the wall mounting bracket : Aluminium alloy ADC-12
- Color of the wall mounting bracket : Black <BK> powder coating
- Sales package: 2 pcs/bag
(2 pcs of each mounting brackets & M3.5 X 6mm stainless screws)



Example



Item Number	Color	External Dimension (mm)
ALMF-002PBK	Painted Black	25 x 18 x 3

Optional PCB

- Material of the PCB : Glass epoxy board (FR-4) ,both sides.
- Thickness of the PCB is 1.6mm, hole & hole distance is 2.54mm

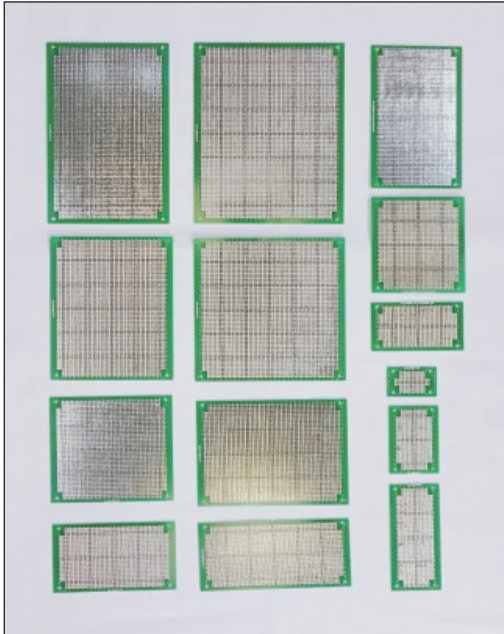

Item Number	External Dimension(mm)		
	LENGTH	WIDTH	HEIGHT
ALUG702040-PCB	32	53.3	1.6
ALUG702080-PCB	72	53.3	1.6
ALUG702120-PCB	112	53.3	1.6
ALUG704060-PCB	52	98.3	1.6
ALUG704110-PCB	102	98.3	1.6
ALUG704160-PCB	152	98.3	1.6
ALUG705060-PCB	52	98.3	1.6
ALUG705110-PCB	102	98.3	1.6
ALUG705160-PCB	152	98.3	1.6
ALUG706080-PCB	72	129.8	1.6
ALUG706120-PCB	112	129.8	1.6
ALUG706160-PCB	152	129.8	1.6
ALUG706200-PCB	192	129.8	1.6
ALUG708080-PCB	72	159.8	1.6
ALUG708120-PCB	112	159.8	1.6
ALUG708160-PCB	152	159.8	1.6
ALUG708200-PCB	192	159.8	1.6

Example

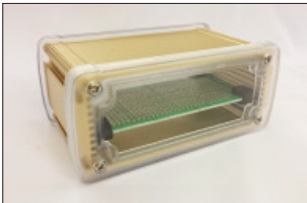

PCB Stopper

- Material of PCB Stopper : CR(Neoprene) with 3M glue adhesive tape
- Sales package: 20 pcs/bag



Item Number	External Dimension (mm)
ALUG7XX-PCBSTOP	22 X 8 x 3

Example

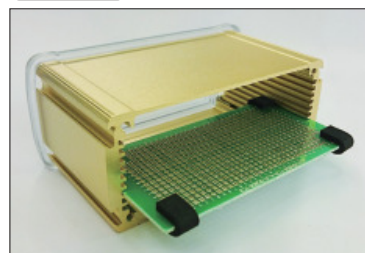

CONTENT

TYPE A Series - Aluminium end panel with extruded aluminium body

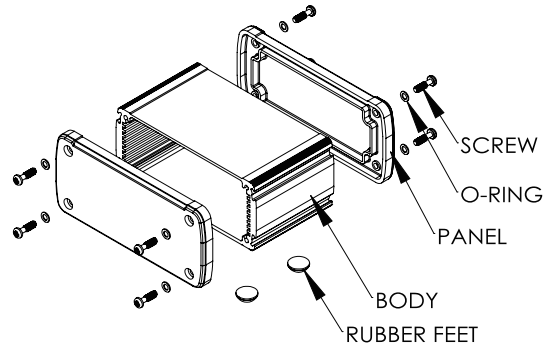

1. Extruded aluminium body



2. Aluminium end panel

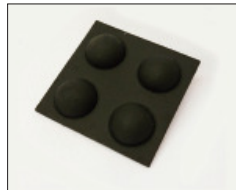

3. Rubber Feet



4. Stainless screw and Polycarbonate washer

TYPE B Series - Plastic end panel with extruded aluminium body

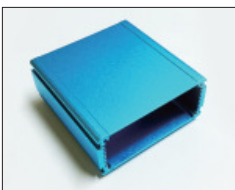
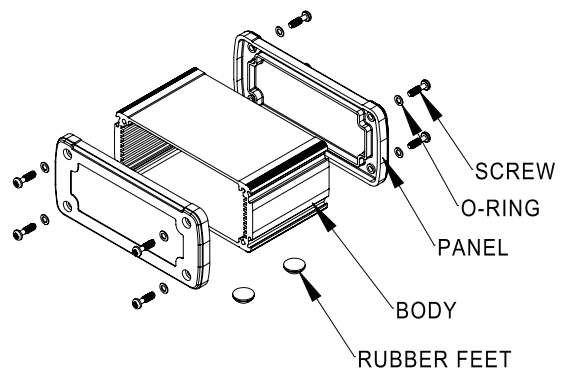

1. Extruded aluminium body



2. Plastic end panel



3. Rubber Feet



4. Stainless screw and Polycarbonate washer

► How to install the seal into the plastic cover/aluminium cover



TYPE A

Seal / Aluminium cover
(PS: the same installation as plastic cover)



TYPE B

Seal / Plastic cover

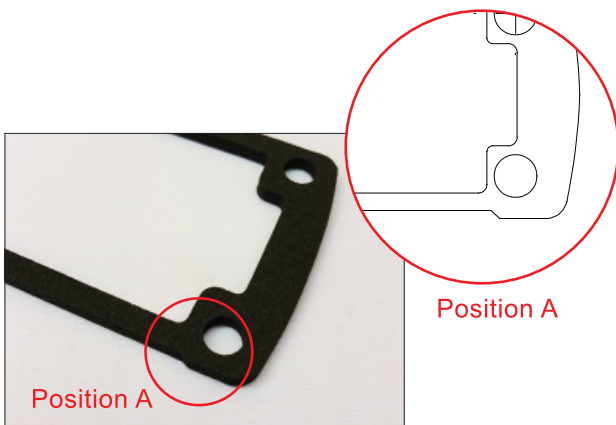

1. Pay attention on the seal
(Position A).

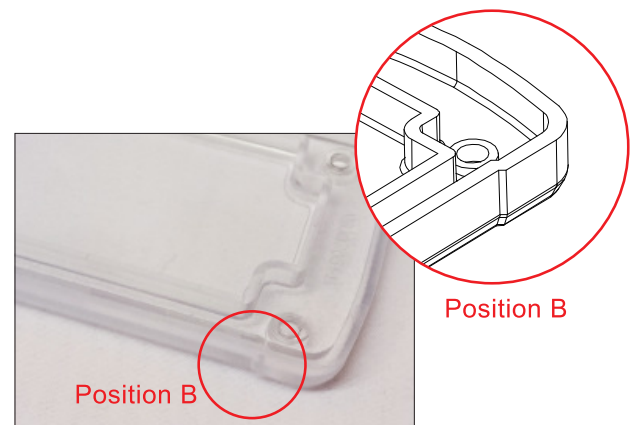

2. Pay attention on the cover
(Position B).

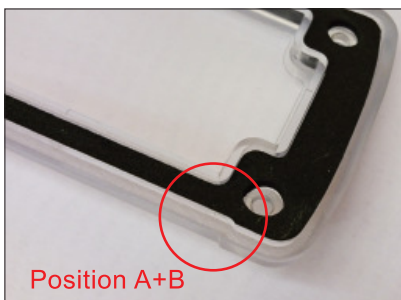

3. Should be installed in the same side.
(position A+B), (position B+C)

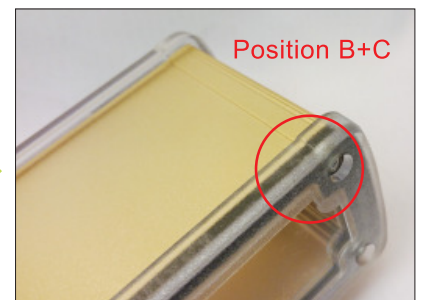
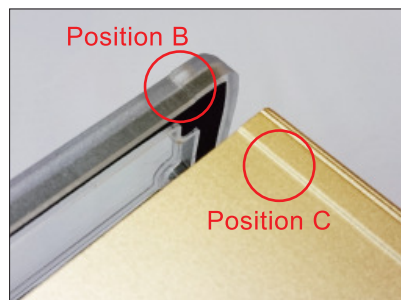

4. Done.

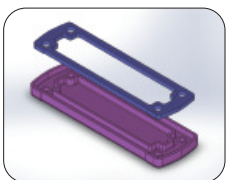

Position A+B



Position B

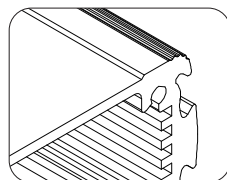

Position C

► How to use the PCB & PCB Stopper



1. PCB / PCB STOPPER

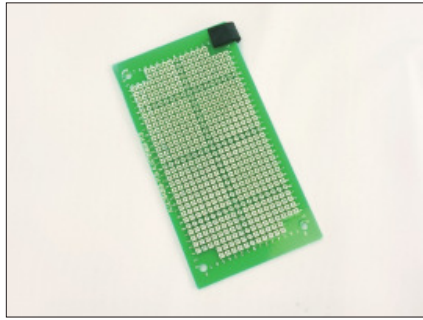

2. Remove the paper from the PCB STOPPER and affix the rubber on the hole of the PCB.

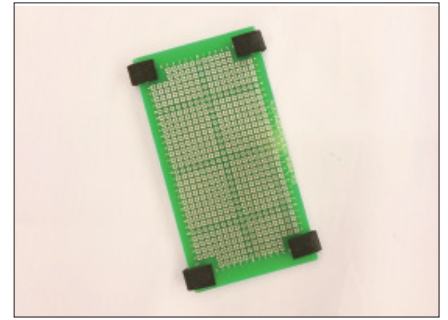

3. Repeat 2 for the other holes.

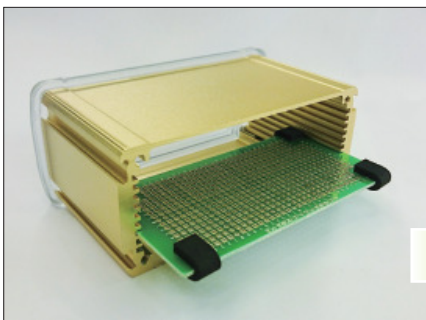

4. Insert the PCB into the extruded body.

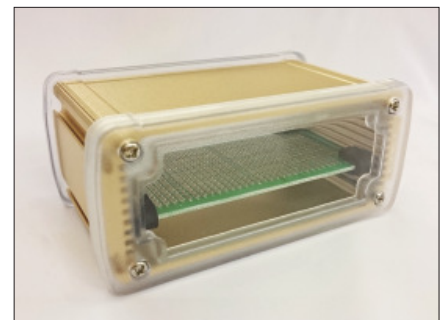
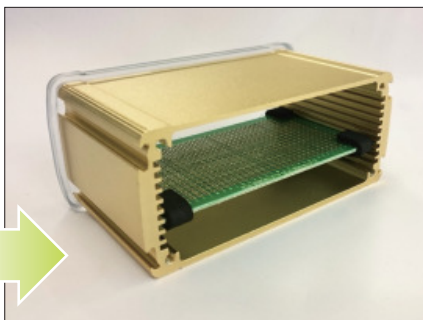

5. Done.

► How to affix the rubber feet



1. Rubber Feet (4pcs/sheet)



2. Extruded body

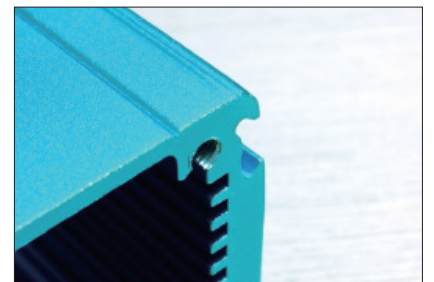

3. Rubber feet adhesive line

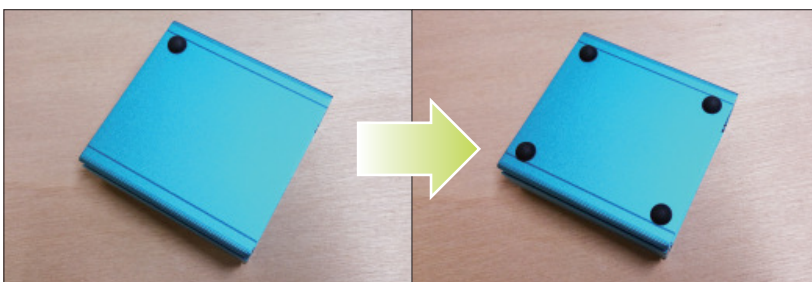

4. Per the photo, Affix the rubber feet in the extruded body.

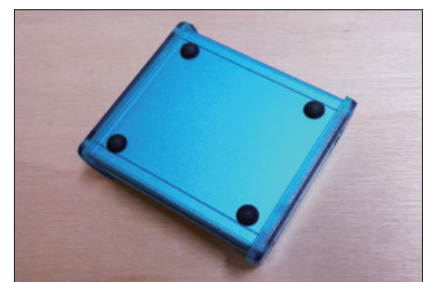

5. Done.