

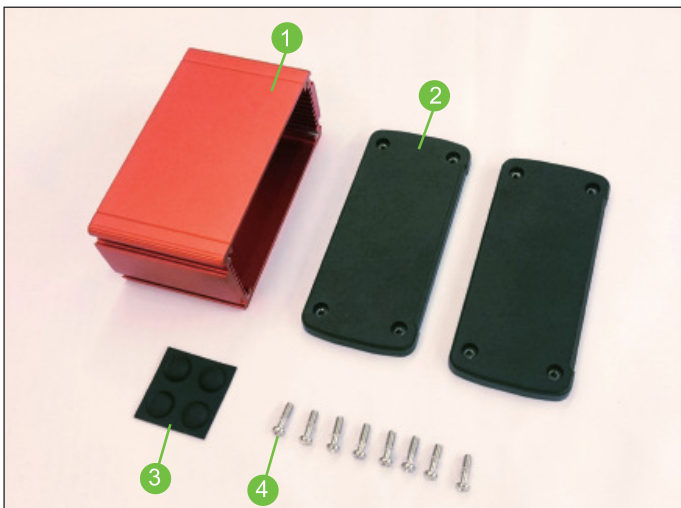













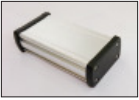

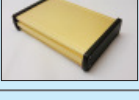

**PRODUCT INFORMATION**











- Material of the aluminium body : Aluminium alloy 6063
- Material of the aluminium end panel : Aluminium alloy ADC-12
- Color of the aluminium body : Golden <GD> , Silver <SR>, Red <RD> , Blue <BU> & Black <BK> anodized finish
- Color of the aluminium end panel : Black powder coating

**Content**



- 1: Aluminium body
- 2: Aluminium end panel
- 3: Rubber feet
- 4: Stainless screw and Polycarbonate washer

※ Reference Product Photo	Item number	COLOR		External Dimension (mm)
		Extruded Aluminium Body	Aluminium end Panels	
	※ ALUG702GD040	Golden	Painted Black	68.7 x 35.2 x 49
	ALUG702GD080	Golden	Painted Black	68.7 x 35.2 x 89
	ALUG702GD120	Golden	Painted Black	68.7 x 35.2 x 129
	ALUG702SR040	Silver	Painted Black	68.7 x 35.2 x 49
	ALUG702SR080	Silver	Painted Black	68.7 x 35.2 x 89
	※ ALUG702SR120	Silver	Painted Black	68.7 x 35.2 x 129
	ALUG702RD040	Red	Painted Black	68.7 x 35.2 x 49
	※ ALUG702RD080	Red	Painted Black	68.7 x 35.2 x 89
	ALUG702RD120	Red	Painted Black	68.7 x 35.2 x 129
	ALUG702BU040	Blue	Painted Black	68.7 x 35.2 x 49
	※ ALUG702BU080	Blue	Painted Black	68.7 x 35.2 x 89
	ALUG702BU120	Blue	Painted Black	68.7 x 35.2 x 129
	ALUG702BK040	Black	Painted Black	68.7 x 35.2 x 49
	※ ALUG702BK080	Black	Painted Black	68.7 x 35.2 x 89
	ALUG702BK120	Black	Painted Black	68.7 x 35.2 x 129
	ALUG704GD060	Golden	Painted Black	113.7 x 35.2 x 69
	ALUG704GD110	Golden	Painted Black	113.7 x 35.2 x 119
	※ ALUG704GD160	Golden	Painted Black	113.7 x 35.2 x 169
	ALUG704SR060	Silver	Painted Black	113.7 x 35.2 x 69
	※ ALUG704SR110	Silver	Painted Black	113.7 x 35.2 x 119
	ALUG704SR160	Silver	Painted Black	113.7 x 35.2 x 169
	ALUG704RD060	Red	Painted Black	113.7 x 35.2 x 69
	※ ALUG704RD110	Red	Painted Black	113.7 x 35.2 x 119
	ALUG704RD160	Red	Painted Black	113.7 x 35.2 x 169
	ALUG704BU060	Blue	Painted Black	113.7 x 35.2 x 69
	※ ALUG704BU110	Blue	Painted Black	113.7 x 35.2 x 119
	ALUG704BU160	Blue	Painted Black	113.7 x 35.2 x 169
	ALUG704BK060	Black	Painted Black	113.7 x 35.2 x 69
	※ ALUG704BK110	Black	Painted Black	113.7 x 35.2 x 119
	ALUG704BK160	Black	Painted Black	113.7 x 35.2 x 169
	ALUG705GD060	Golden	Painted Black	115.1 x 51.6 x 69
	※ ALUG705GD110	Golden	Painted Black	115.1 x 51.6 x 119
	ALUG705GD160	Golden	Painted Black	115.1 x 51.6 x 169
	ALUG705SR060	Silver	Painted Black	115.1 x 51.6 x 69
	ALUG705SR110	Silver	Painted Black	115.1 x 51.6 x 119
	※ ALUG705SR160	Silver	Painted Black	115.1 x 51.6 x 169
	ALUG705RD060	Red	Painted Black	115.1 x 51.6 x 69
	※ ALUG705RD110	Red	Painted Black	115.1 x 51.6 x 119
	ALUG705RD160	Red	Painted Black	115.1 x 51.6 x 169
	ALUG705BU060	Blue	Painted Black	115.1 x 51.6 x 69
	※ ALUG705BU110	Blue	Painted Black	115.1 x 51.6 x 119
	ALUG705BU160	Blue	Painted Black	115.1 x 51.6 x 169
	ALUG705BK060	Black	Painted Black	115.1 x 51.6 x 69
	※ ALUG705BK110	Black	Painted Black	115.1 x 51.6 x 119
	ALUG705BK160	Black	Painted Black	115.1 x 51.6 x 169

※ Reference Product Photo	Item number	COLOR		External Dimension (mm)
		Extruded Aluminium Body	Aluminium end Panels	
	※ ALUG706GD080	Golden	Painted Black	146.6 x 41.6 x 89
	ALUG706GD120	Golden	Painted Black	146.6 x 41.6 x 129
	ALUG706GD160	Golden	Painted Black	146.6 x 41.6 x 169
	ALUG706GD200	Golden	Painted Black	146.6 x 41.6 x 209
	ALUG706SR080	Silver	Painted Black	146.6 x 41.6 x 89
	ALUG706SR120	Silver	Painted Black	146.6 x 41.6 x 129
	※ ALUG706SR160	Silver	Painted Black	146.6 x 41.6 x 169
	ALUG706SR200	Silver	Painted Black	146.6 x 41.6 x 209
	ALUG706RD080	Red	Painted Black	146.6 x 41.6 x 89
	ALUG706RD120	Red	Painted Black	146.6 x 41.6 x 129
	※ ALUG706RD160	Red	Painted Black	146.6 x 41.6 x 169
	ALUG706RD200	Red	Painted Black	146.6 x 41.6 x 209
	ALUG706BU080	Blue	Painted Black	146.6 x 41.6 x 89
	ALUG706BU120	Blue	Painted Black	146.6 x 41.6 x 129
	ALUG706BU160	Blue	Painted Black	146.6 x 41.6 x 169
	※ ALUG706BU200	Blue	Painted Black	146.6 x 41.6 x 209
	ALUG706BK080	Black	Painted Black	146.6 x 41.6 x 89
	※ ALUG706BK120	Black	Painted Black	146.6 x 41.6 x 129
	ALUG706BK160	Black	Painted Black	146.6 x 41.6 x 169
	ALUG706BK200	Black	Painted Black	146.6 x 41.6 x 209
	ALUG708GD080	Golden	Painted Black	177.6 x 61.1 x 89
	ALUG708GD120	Golden	Painted Black	177.6 x 61.1 x 129
	ALUG708GD160	Golden	Painted Black	177.6 x 61.1 x 169
	※ ALUG708GD200	Golden	Painted Black	177.6 x 61.1 x 209
	ALUG708SR080	Silver	Painted Black	177.6 x 61.1 x 89
	※ ALUG708SR120	Silver	Painted Black	177.6 x 61.1 x 129
	ALUG708SR160	Silver	Painted Black	177.6 x 61.1 x 169
	ALUG708SR200	Silver	Painted Black	177.6 x 61.1 x 209
	※ ALUG708RD080	Red	Painted Black	177.6 x 61.1 x 89
	ALUG708RD120	Red	Painted Black	177.6 x 61.1 x 129
	ALUG708RD160	Red	Painted Black	177.6 x 61.1 x 169
	ALUG708RD200	Red	Painted Black	177.6 x 61.1 x 209
	ALUG708BU080	Blue	Painted Black	177.6 x 61.1 x 89
	ALUG708BU120	Blue	Painted Black	177.6 x 61.1 x 129
	※ ALUG708BU160	Blue	Painted Black	177.6 x 61.1 x 169
	ALUG708BU200	Blue	Painted Black	177.6 x 61.1 x 209
	ALUG708BK080	Black	Painted Black	177.6 x 61.1 x 89
	ALUG708BK120	Black	Painted Black	177.6 x 61.1 x 129
	※ ALUG708BK160	Black	Painted Black	177.6 x 61.1 x 169
	ALUG708BK200	Black	Painted Black	177.6 x 61.1 x 209

# Continuous Rubber Seal, Wall Mounting bracket

## Continuous Rubber Seal

- Material of the continuous rubber seal : CR ( Neoprene )
- Color of the continuous rubber seal : Black

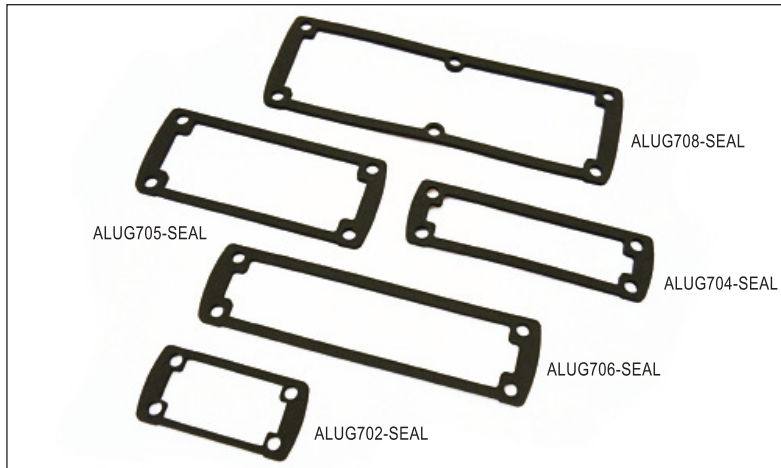

### Example

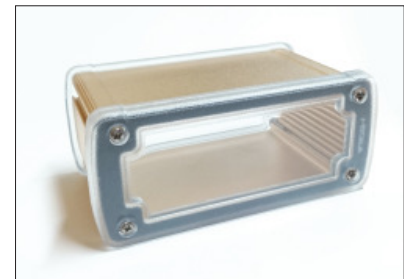
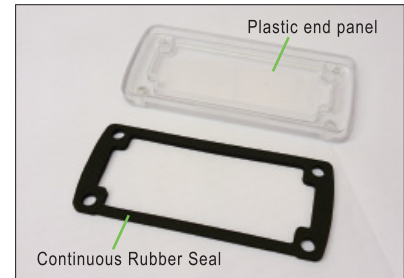

Item Number	Color	External Dimension (mm)
<b>ALUG702-SEAL</b>	Black	64.7 x 31.2 x 3
<b>ALUG704-SEAL</b>	Black	109.7 x 31.2 x 3
<b>ALUG705-SEAL</b>	Black	109.7 x 46.2 x 3
<b>ALUG706-SEAL</b>	Black	141.2 x 36.2 x 3
<b>ALUG708-SEAL</b>	Black	171.2 x 54.7 x 3

## Wall Mounting Bracket

- Material of the wall mounting bracket : Aluminium alloy ADC-12
- Color of the wall mounting bracket : Black <BK> powder coating
- Sales package: 2 pcs/bag  
(2 pcs of each mounting brackets & M3.5 X 6mm stainless screws)



### Example



Item Number	Color	External Dimension (mm)
<b>ALMF-002PBK</b>	Painted Black	25 x 18 x 3

## Optional PCB

- Material of the PCB : Glass epoxy board ( FR-4 ) ,both sides.
- Thickness of the PCB is 1.6mm, hole & hole distance is 2.54mm

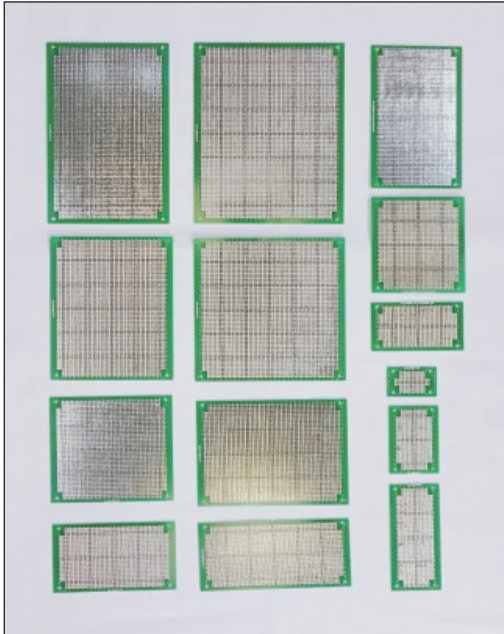

Item Number	External Dimension(mm)		
	LENGTH	WIDTH	HEIGHT
ALUG702040-PCB	32	53.3	1.6
ALUG702080-PCB	72	53.3	1.6
ALUG702120-PCB	112	53.3	1.6
ALUG704060-PCB	52	98.3	1.6
ALUG704110-PCB	102	98.3	1.6
ALUG704160-PCB	152	98.3	1.6
ALUG705060-PCB	52	98.3	1.6
ALUG705110-PCB	102	98.3	1.6
ALUG705160-PCB	152	98.3	1.6
ALUG706080-PCB	72	129.8	1.6
ALUG706120-PCB	112	129.8	1.6
ALUG706160-PCB	152	129.8	1.6
ALUG706200-PCB	192	129.8	1.6
ALUG708080-PCB	72	159.8	1.6
ALUG708120-PCB	112	159.8	1.6
ALUG708160-PCB	152	159.8	1.6
ALUG708200-PCB	192	159.8	1.6

Example

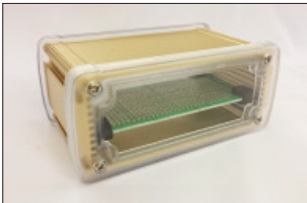

## PCB Stopper

- Material of PCB Stopper : CR(Neoprene ) with 3M glue adhesive tape
- Sales package: 20 pcs/bag



Item Number	External Dimension (mm)
ALUG7XX-PCBSTOP	22 X 8 x 3

Example

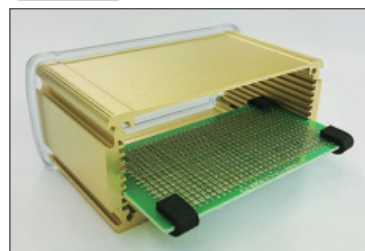

# CONTENT

## TYPE A Series - Aluminium end panel with extruded aluminium body

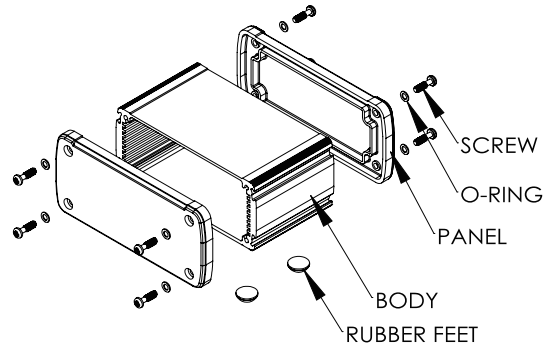

1. Extruded aluminium body



2. Aluminium end panel

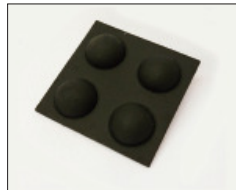

3. Rubber Feet



4. Stainless screw and Polycarbonate washer

## TYPE B Series - Plastic end panel with extruded aluminium body

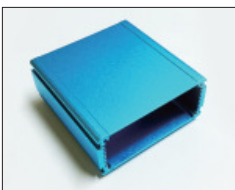
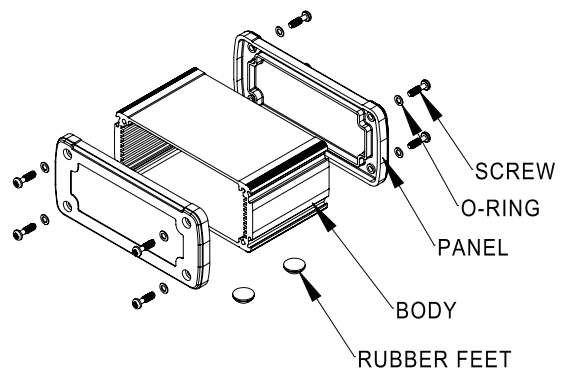

1. Extruded aluminium body



2. Plastic end panel



3. Rubber Feet



4. Stainless screw and Polycarbonate washer

# ► How to install the seal into the plastic cover/aluminium cover



## TYPE A

Seal / Aluminium cover  
(PS: the same installation as plastic cover)



## TYPE B

Seal / Plastic cover

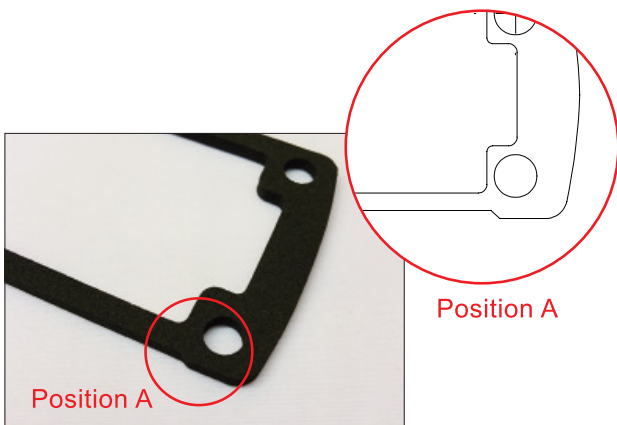

1. Pay attention on the seal  
(Position A).

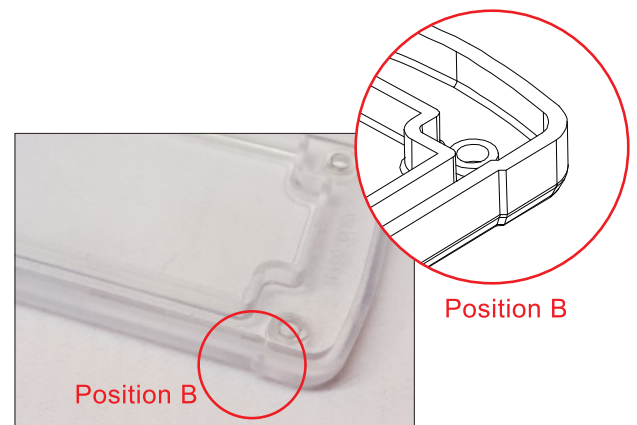

2. Pay attention on the cover  
(Position B).

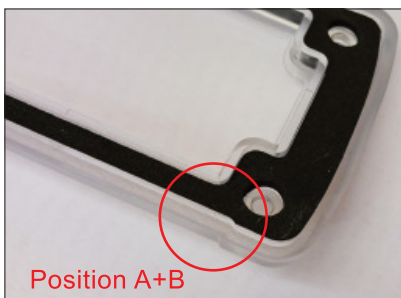

3. Should be installed in the same side.  
(position A+B), (position B+C)

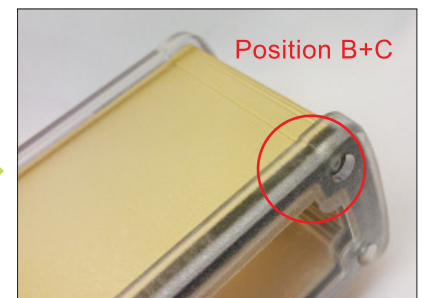
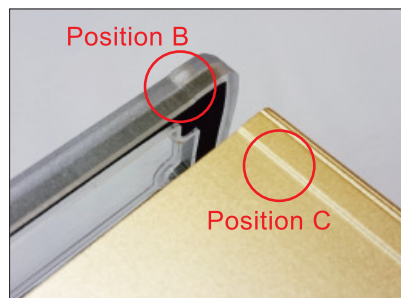

4. Done.

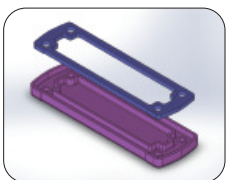

Position A+B



Position B

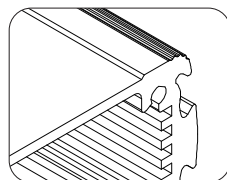

Position C

## ► How to use the PCB & PCB Stopper



1. PCB / PCB STOPPER

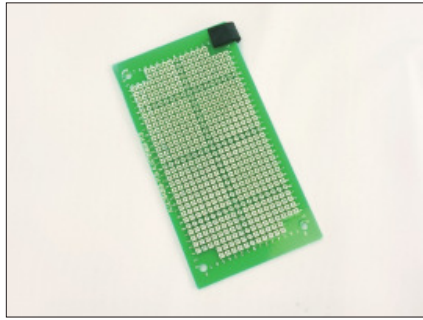

2. Remove the paper from the PCB STOPPER and affix the rubber on the hole of the PCB.

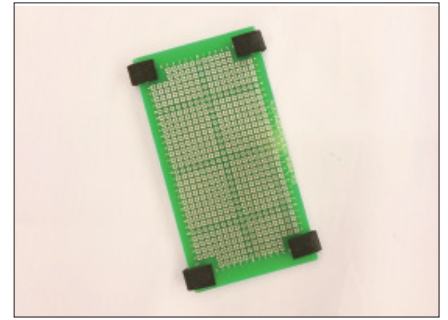

3. Repeat 2 for the other holes.

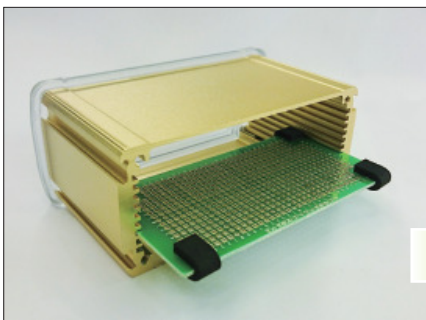

4. Insert the PCB into the extruded body.

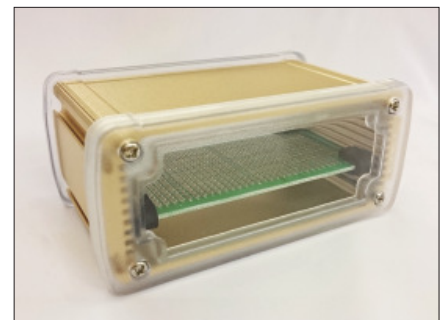
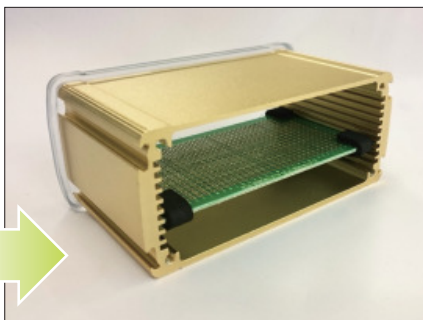

5. Done.

## ► How to affix the rubber feet



1. Rubber Feet (4pcs/sheet)



2. Extruded body

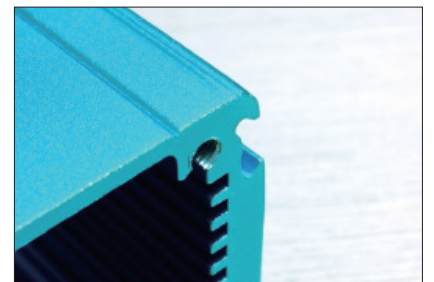

3. Rubber feet adhesive line

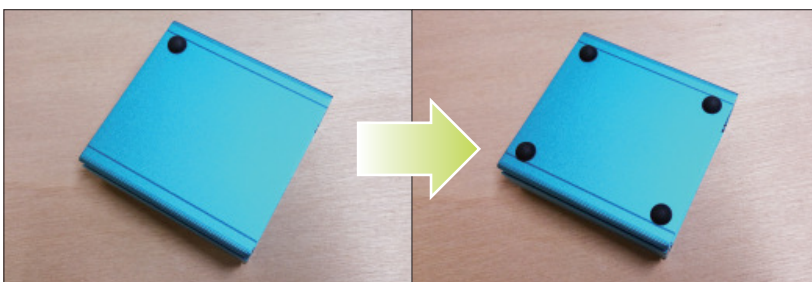

4. Per the photo, Affix the rubber feet in the extruded body.

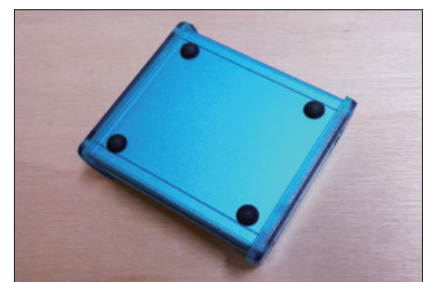

5. Done.