

*Maxair*TM

SPECIFICATIONS

FOR APPROVAL

Model: 8025S2HL

AC220V 50/60Hz 0.07/0.06A



SPECIFICATION

<u>Item</u>	<u>Specification/Condition</u>
Dimension	: 80x80x25 mm
Bearing System	: SLEEVE BEARING
Rated Voltage	: 220 VAC
Operating Voltage	: 200 VAC—240 VAC
Start-up Voltage	: 160 VAC NORMALLY
Rated Current	: 0.07/0.06 Amp NORMALLY
Rated Power	: 14/13 Watt NORMALLY
Rated Speed	: 2550/2900 RPM±10%
Air Flow	: 0.51/0.62 m ³ /min (18 /22 CFM)
Static Air Pressure	: 3.3/4.83mmH ₂ O
Noise Level	: 29/33dBA
Motor Protection Type	: BY IMPEDANCE
Life Expectance	: 20000 Hours at Room Temperature
Operation Temperature	: -10°C to +70°C
Net Weight	: 260 Grams

Maxair™

MATERIAL

1. Impeller : Thermoplastic PBT of UL 94V-0
2. Bobbin : Thermoplastic PA66 of UL 94V-0
3. Lead Wire : UL 1430 AWG#22 280mm—BLACK

DIMENSIONS: MM

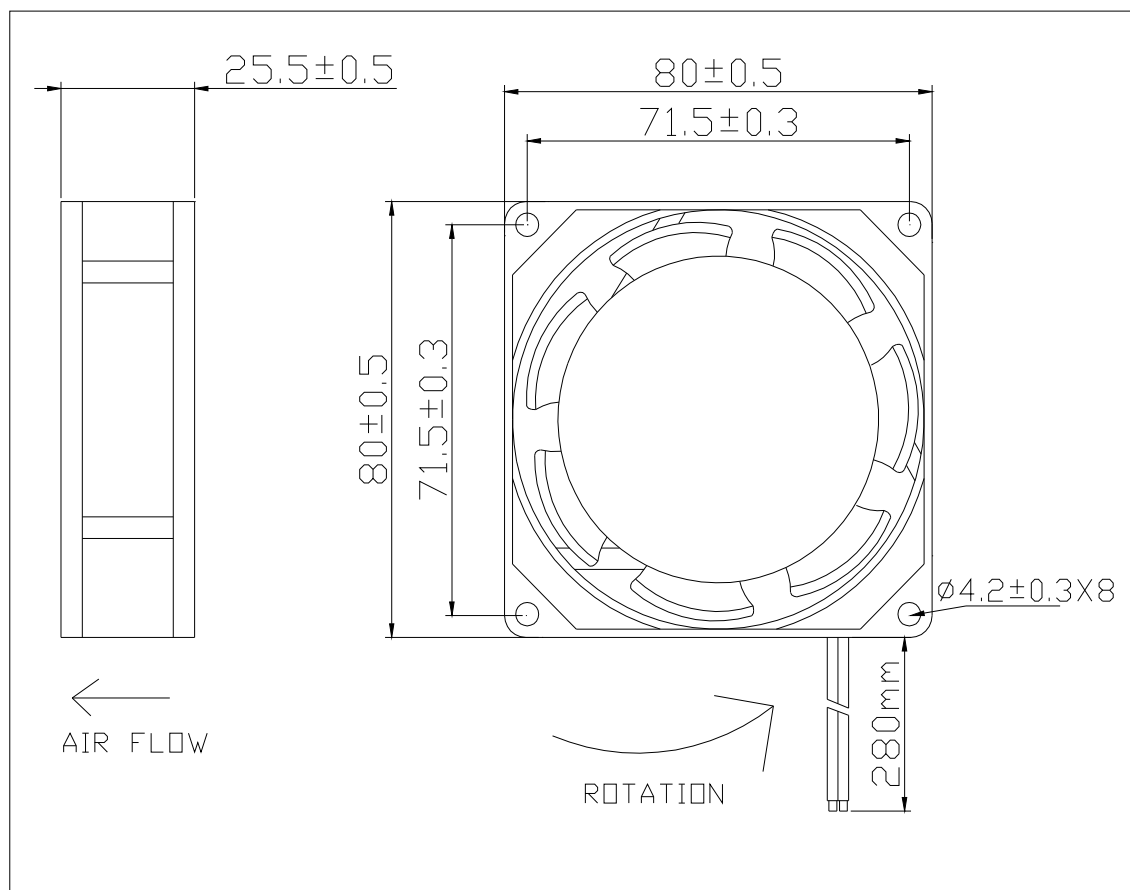

Maxair™

Performance Curve

