

REV.	DESCRIPTION	DRAWN	CHECKED	APPROVED
A	NEW RELEASE	LJH 09/26/05'		LJC 09/26/05'
B	整理图面	YCH 05/26/07'		LJC 05/26/07'
C	增加锁螺丝类型	YCH 06/30/07'		

NOTES:

- ELECTRICAL CHARACTERISTICS:
  - CONTACT RESISTANCE: 20mΩ Max. INITIAL.
  - DIELECTRIC WITHSTANDING VOLTAGE: 500V AC(rms) FOR 1 MINUTE.
  - INSULATION RESISTANCE: 1000MΩ Min.
- ENVIRONMENT CHARACTERISTICS:
 

TEMPERATURE RANGE: -45°C~+105°C.
- PART NUMBER: DS1035
- PRODUCT NUMBER CODE:  
DS1035- X X X X X X X

- SCREW DIM. A
  - S: Standard(W/O nut)
  - 1: 3.00
  - 2: 4.00
  - 3: 4.50
  - 4: 5.00
  - 5: 5.50
  - 6: 5.80
- SCREW TYPE
  - S: Standard(W/O nut)
  - 1: CC TYPE
  - 2: CS TYPE
- CONTACT PLATING
  - 8: FULL GOLD FLASH
  - Si: SELECTIVE GOLD FLASH
- SHELL PLATING
  - T: FRONT & BACK SHELL TIN
  - N: FRONT SHELL NICKEL, BACK SHELL TIN
- HOUSING COLOR
  - B: BLACK
  - W: WHITE
  - U: BLUE
- CONNECTOR TYPE
  - M: MALE
  - F: FEMALE
- No. OF CONTACTS
  - 15: 15pos.
  - 26: 26pos.
  - 44: 44pos.
  - 62: 62pos.

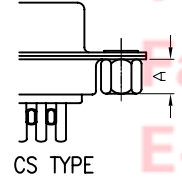
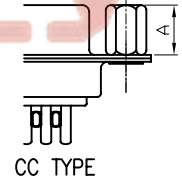
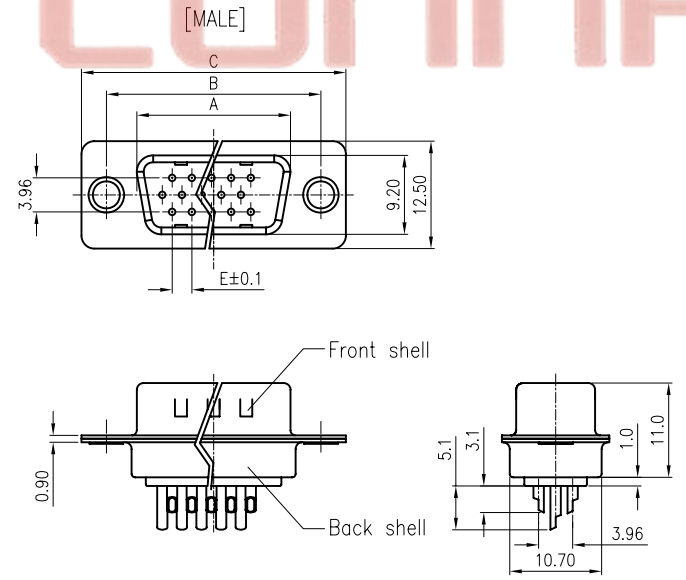
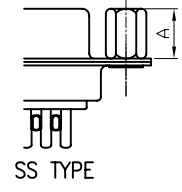
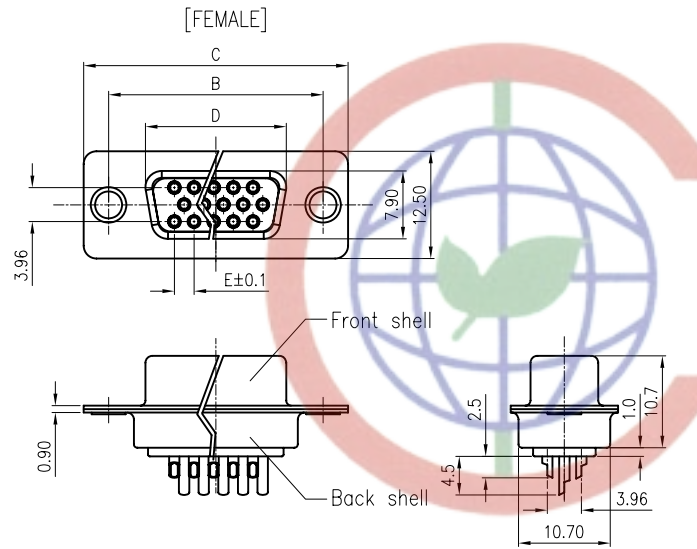

Dimension

Position	A±0.2	B±0.2	C±0.3	D	E
15	17.90	24.99	30.80	16.33	2.29
26	26.50	33.32	39.14	24.66	2.29
44	40.00	47.04	53.04	38.38	2.29
62	56.50	63.50	69.32	54.84	2.14
78	54.30	61.00	67.04	52.34	2.14

GENERAL TOLERANCE		ANGLE TOLERANCE	
X.	±0.60	X.	±5°
.X	±0.38	.X	±3°
.XX	±0.25	.XX	±2°

DRAWING TYPE	CUSTOMER
SCALE	1:1
DRAWING NO.	C-DS1035-XXXXXXX

PROJECTION	TITLE
	D-SUB H.D SOLDER TYPE
UNITS	mm
SHEET SIZE	A4
SERIES	DS1035 SERIES

**晨翔电子有限公司**  
**CONNFLY CONNFLY ELECTRONIC CO. LTD**

Tel:86-574-6350871  
 Fax:86-574-6351081  
 E-mail:sale@zhengqiang.com.cn  
 Http://www.connfly.com

REV.	DESCRIPTION	DRAWN	CHECKED	APPROVED
A	NEW RELEASE	LL 12/06/06'		LJC 12/06/06'
B	增加锁螺丝类型	YCH 06/30/07'		

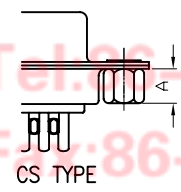
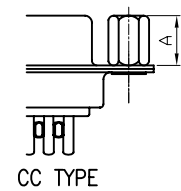
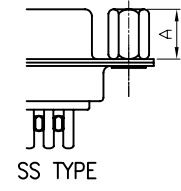
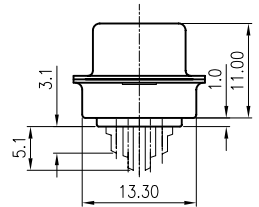
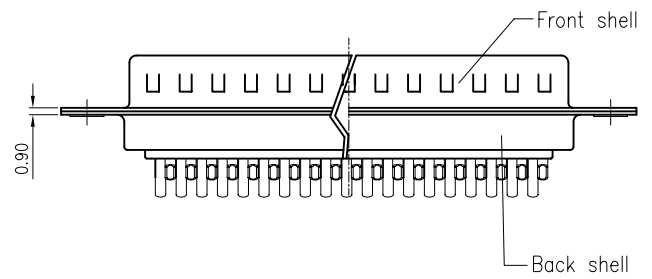
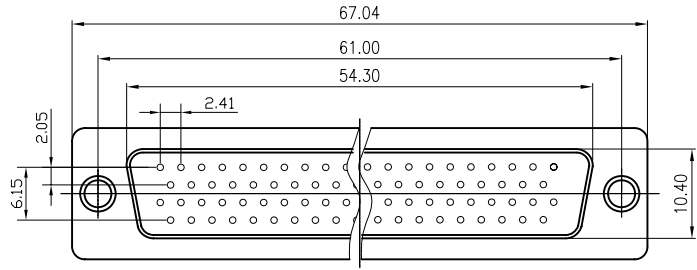
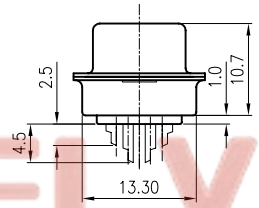
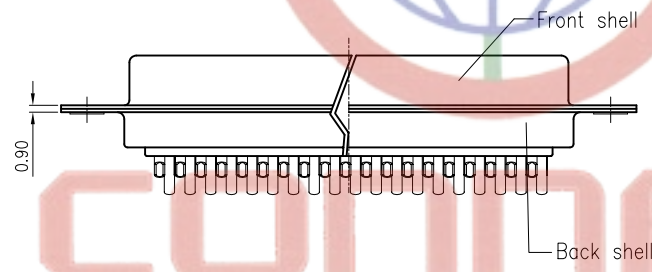
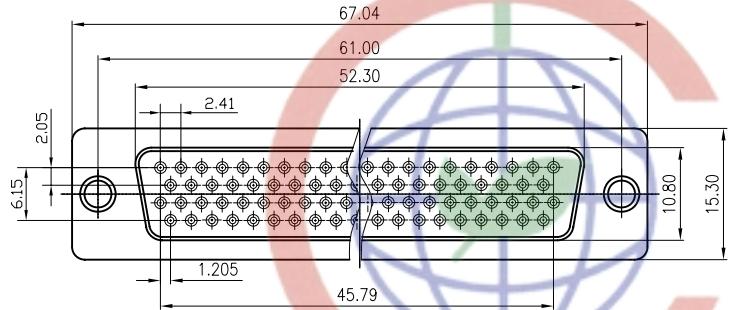

NOTES:

- ELECTRICAL CHARACTERISTICS:
  - CONTACT RESISTANCE: 20mΩ Max. INITIAL.
  - DIELECTRIC WITHSTANDING VOLTAGE: 500V AC(rms) FOR 1 MINUTE.
  - INSULATION RESISTANCE: 1000MΩ Min.
- ENVIRONMENT CHARACTERISTICS:
 

TEMPERATURE RANGE: -45°C~+105°C.
- PRODUCT NUMBER CODE:

DS1035- X X X X X X X

- SCREW DIM. A
  - S: Standard(W/O nut)
  - 1: 3.00
  - 2: 4.00
  - 3: 4.50
  - 4: 5.00
  - 5: 5.50
  - 6: 5.80
- SCREW TYPE
  - S: Standard(W/O nut)
  - 1: CC TYPE
  - 2: CS TYPE
- CONTACT PLATING
  - 8: FULL GOLD FLASH
  - Si: SELECTIVE GOLD FLASH
- SHELL PLATING
  - T: FORNT & BACK SHELL TIN
  - N: FORNT SHELL NICKEL, BACK SHELL TIN
- HOUSING COLOR
  - B: BLACK
  - W: WHITE
  - U: BLUE
- CONNECTOR TYPE
  - M: MALE
  - F: FEMALE
- No. OF CONTACTS
  - 78: 78pos.

Tel: 86-574-635087  
 Fax: 86-574-6351081  
 E-mail: sale@zhenqin.com.cn  
 Http://www.connfly.com

GENERAL TOLERANCE		ANGLE TOLERANCE		PROJECTION	TITLE
X.	±0.60	X.	±5°		D-SUB H.D SOLDER TYPE
.X	±0.38	.X	±3°	mm	
.XX	±0.25	.XX	±2°		SHEET SIZE A4
DRAWING TYPE		CUSTOMER		SERIES DS1035 SERIES	
SCALE		1:1	SHEET		1 OF 1
DRAWING NO.		C-DS1035-78XXXXXX			

晨翔电子有限公司  
**CONNFLY CONNFLY ELECTRONIC CO. LTD**