

# Customer: ART

Part no.: AL-M30R

## Benefits:

- High intensity
- Low power consumption
- Solid state reliability
- Optimal optical and mechanical design

## Features:

- 3.0\*5.3mm lamp LED
- Lens color: White diffused
- Emitting color: Red, AlGaInP
- Viewing angle: 60°

## Package Dimensions:

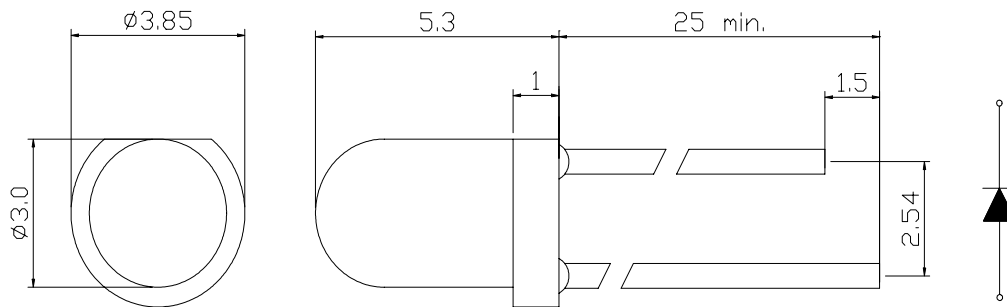

## Notes:

- All dimensions are in millimeters
- Tolerance is  $\pm 0.25$ mm unless otherwise noted.
- Specifications are subject to change without notice

## Absolute Maximum Ratings At Ta=25°C

Parameter	Symbol	Ratings	Unit
Power Dissipation	Pd	60	mW
Peak Forward Current (1/10 Duty Cycle, 0.1ms Pulse Width)	Ifp	100	mA
Forward Current	If	30	mA
Reverse Voltage	Vr	5	V
Soldering Temperature Range	Tsol	Reflow soldering for 260°C within 10s Hand soldering for 300°C within 3s	
Operating Temperature Range	Topr	-30°C to + 85°C	
Storage Temperature Range	Tstg	-40°C to + 85°C	

# Customer: ART

Part no.: AL-M30R

## Electrical/Optical Characteristics At Ta=25°C

Parameter	Symbol	Min.	Typ.	Max.	Unit	Condition
Luminous Intensity	$I_v$	—	150	—	mcd	$I_F=20\text{mA}$
Viewing Angle	$2\theta_{1/2}$	—	60	—	Deg.	$I_F=20\text{mA}$
Dominant Wavelength	$\lambda_d$	—	635	—	nm	$I_F=20\text{mA}$
Forward Voltage	$V_F$	1.8	—	2.4	V	$I_F=20\text{mA}$
Reverse Current	$I_R$	—	—	10	$\mu\text{A}$	$V_R=5\text{V}$

## Electrical/Optical Characteristics At Ta=25°C

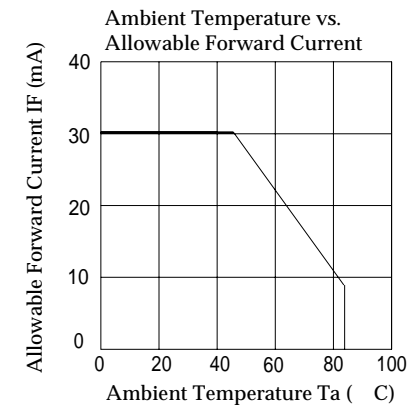
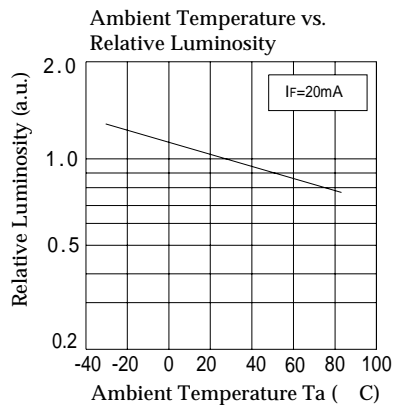
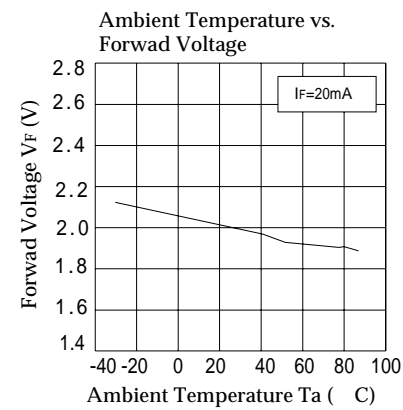
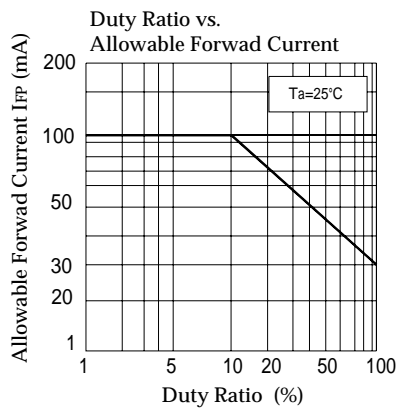
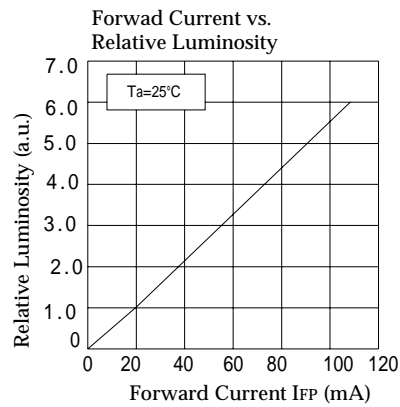
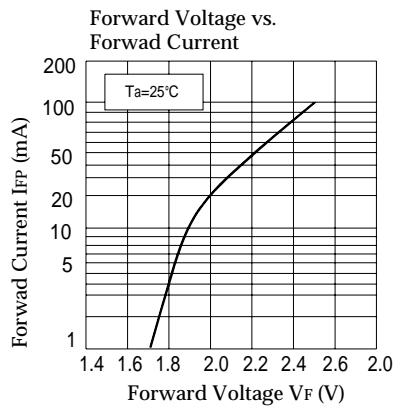

---

## **Precautions for use:**

### 1. Lead Forming & Assembly

- Any lead forming or bending must be done before soldering, at normal temperature.
- When forming leads, there must be a minimum of 3mm clearance between the base of the LED lens and the lead bend.
- Do not use the base of the lead frame as a fulcrum during lead forming.
- Avoid bending the leads at the same point more than once.
- During assembly onto PCB, the lead pitch of the LED must match the pitch of the mounting holes on the PCB during component placement.

### 2. Cleaning:

- Isopropyl alcohol or deionized water are recommended solvents for cleaning. When using other solvents, it should be confirmed beforehand whether the solvents will dissolve the resin or not.

### 3. Storage

- The storage ambient for the LEDs should not exceed 30°C temperature or 70% relative humidity.
- It is recommended that LEDs out of their original packaging are used within three months. For extended storage out of their original packaging, it is recommended that the LEDs be stored in a sealed container with appropriate desiccant or in desiccators with nitrogen ambient.

### 4. ESD (Electrostatic Discharge)

Static Electricity or power surge will damage the LED.

The following procedures may decrease the possibility of ESD damage.

- All production machinery and test instruments must be electrically grounded.
- Use a conductive wrist band or anti-electrostatic glove when handling these LEDs.
- Maintain a humidity level of 50% or higher in production areas.
- Use anti-static packaging for transport and storage.