

## Magnetic Transducer Buzzer Series

### KLS3-MT-12\*09 $\Phi$ 12\*9mm Magnetic Transducer Buzzer Series

Dimensions (Unit:mm)

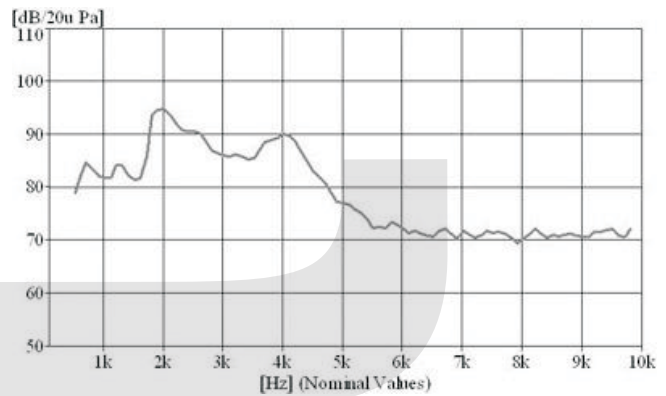
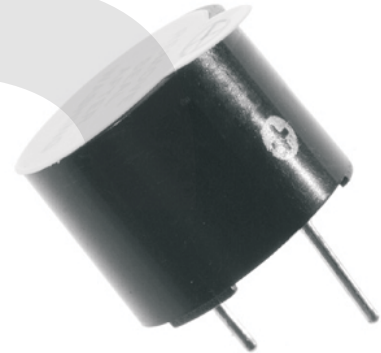
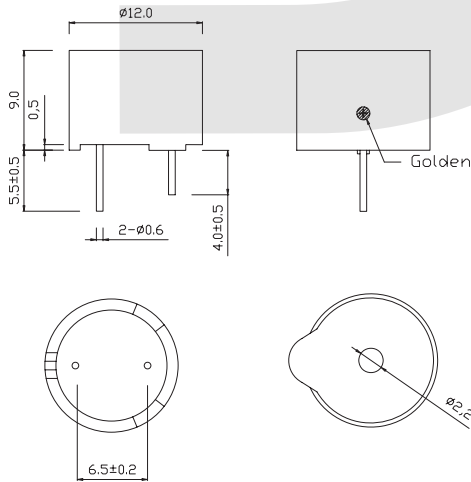

Order Code	Rated Voltage	Max. Rated Current	Coil Resistance	Resonant Frequency	Min. S.P.L. (@10cm)	Operating Voltage	Operating Temp	Weight
KLS3-MT-12*09-A1	1.5V	70mA	6.5±1Ω	2400Hz	80dB	1...2V		
KLS3-MT-12*09-A2	1.5V	30mA	16±2Ω	2048Hz	75dB	1...2V		
KLS3-MT-12*09-A3	1.5V	30mA	16±2Ω	2400Hz	75dB	1...2V		
KLS3-MT-12*09-A4	1.5V	30mA	16±2Ω	2600Hz	75dB	1...2V		
KLS3-MT-12*09-A5	1.5V	70mA	6.5±1Ω	2731Hz	80dB	1...2V	-20°C~ +70°C	2g
KLS3-MT-12*09-A6	1.5V	10mA	45±5Ω	2731Hz	70dB	1...2V		
KLS3-MT-12*09-A7	1.5V	10mA	45±5Ω	2400Hz	70dB	1...2V		
KLS3-MT-12*09-A8	1.5V	30mA	16±2Ω	2800Hz	85dB	1...2V		
KLS3-MT-12*09-B	5V	40mA	45±5Ω	2400Hz	85dB	4...8V		
KLS3-MT-12*09-C	12V	40mA	140±14Ω	2400Hz	85dB	8...16V		

## ORDER INFORMATION

Product NO.: **KLS3- MT - 12\*09 - A1**

Part Number

Magnetic Transducer Buzzer Series

Order Code

Size specifications