

Tact Switch Series

KLS7-TS1205 12x12 Tact Switch Series

ELECTRICAL

1. Rating: 50mA 12VDC
2. Contact Resistance : 50mΩ max(initial)
3. Insulation Resistance: 100MΩ(minDC 250V)
4. Dielectric Strength : AC250V(50/60Hz for 1minute)
5. Electrically Life: 100000cycles
6. Environment temperature: -20°C~+70°C
7. Operating Force: 180/250(±30gf)
8. Seal temperature: 260°C~ 280°C

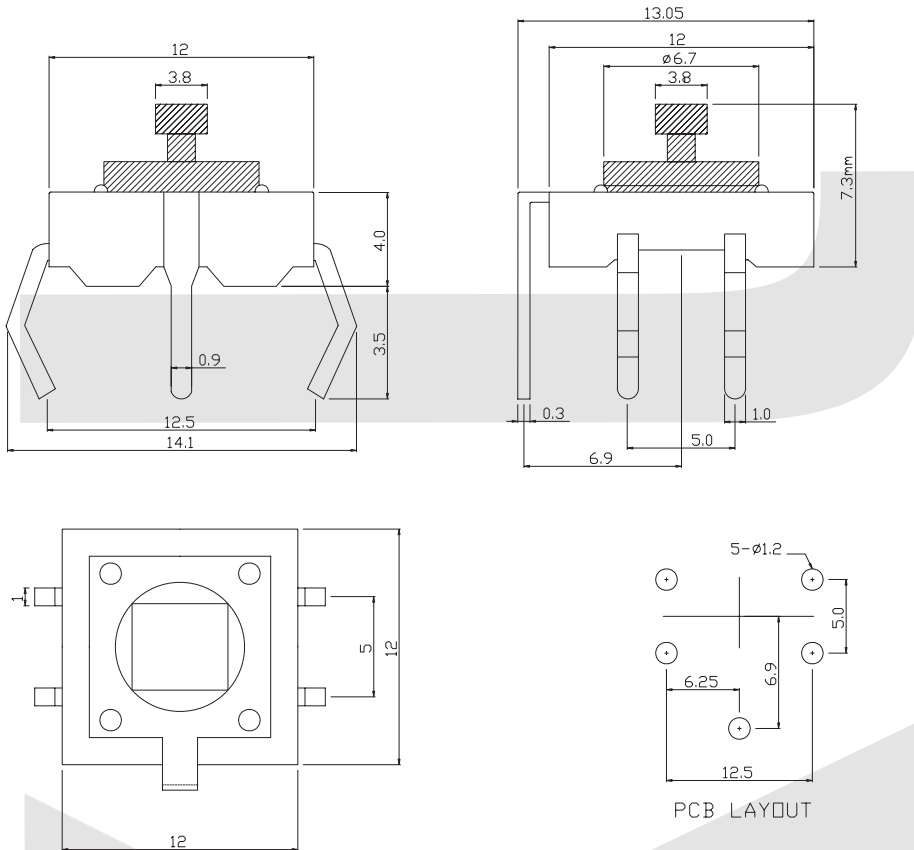

ORDER INFORMATION

KLS7-TS1205 - H1 - 180

Part Number

Operating Force :180~250gf
Hight: H1=7.3mm