





Product Approval Sheet

Customer : _____

Issued no : 2011. 03. 31.

Revision no :

- Product description : Metallized Polyester film capacitors
- Product code : PCMT 365 77104 / PCMT 365 77334
- Application :

CUSTOMER			
PILKOR	Checked	Confirmed	Approved
			

Headquarters : 381, Woncheon-dong, Yeong tong-gu, Suwon-si, Gyeonggi-do, Korea

PILKOR Electronics Co., Ltd.

TEL. +82-31-217-2500

FAX. +82-31-217-7465

China factory : No 25 Zoutai South Road Rongcheng City, Shandong Province China

Rongcheng PILKOR Electronics Co., Ltd.

TEL. +86-631-755-6001~3

FAX, +86-631-755-6004

* Please returned to us this sheet before the order.

□ □ (Contents) □

1. □ □ □ □ (General)	Page 1
2. □ □ □ □ (Construction)	Page 25
3. □ □ □ □ (Characteristics)	Page 26
4. □ □ □ □ □ (Mark & Packing)	Page 30
5. □ □ □ □ □ (Test Requirements)	Page 33

* □ □ □ (Material) LIST

PCMT 365
Type series

X X XXX
Capacitance

Code	I _{max}	Voltage
1	10.0	63V
2		100V
4		250V
5		400V
6		630V
7	7.5	63V
8		100V

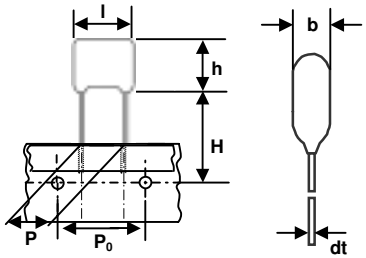
Available versions					Ordering Information	
Code	Packing method	C-tol.	Height (H)	Hole to Hole (P ₀)		
7	Straight Ammo	± 10%	21.0mm	12.7mm		
8	Straight Ammo	± 5%	21.0mm	12.7mm		

□ □ □		MKT RADIAL EPOXY LQCQUERED CAPACITORS	PCMT 365 xxxxx		09- 05- 19	
□ □ □						
			09- 05- 19	1	190- 1	010
QS	□ □ □	(C) PILKOR ELECTRONICS, LTD. 2009				

**Metallized Polyester
film capacitors**

PCMT 365/366/367

MKT RADIAL LACQUERED CAPACITORS (Dipped Type) – Orange

Pitch 5.0/7.5mm

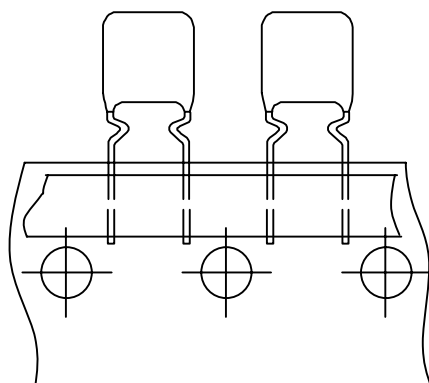

365

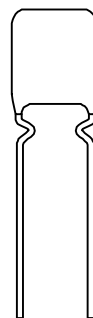

366

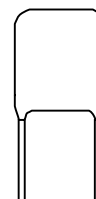

367

QUICK REFERENCE DATA

Capacitance range (E12 series)	0.001 to 1.0□
Capacitance tolerance	± 10%, ± 5%
Rated voltage V_{Rdc}	63 V, 100 V, 250 V, 400 V, 630V
Rated voltage V_{Rac}	40 V, 63 V, 160 V, 220 V, 250V
Climatic category	55/105/56
Temperature range	-55°C ~ +105°C
Reference specification	IEC 60384-2
Performance grade	Grade 1 (long life)
Coating material	Qualified in accordance with UL94V-0

<p>FEATURES</p> <ul style="list-style-type: none"> . Low inductive wound cell of metallized (PETP) film . Cell protected by epoxy lacquer . Radial leads of tin coated wire . Withstand to solvents and rinsing liquids 	<p>APPLICATIONS</p> <ul style="list-style-type: none"> . Blocking and coupling . Bypass and energy reservoir application
--	---

• Please refer to caution and warning at <http://www.pilkor.co.kr/download/Introductions.pdf> before using these products.

Ordering Information

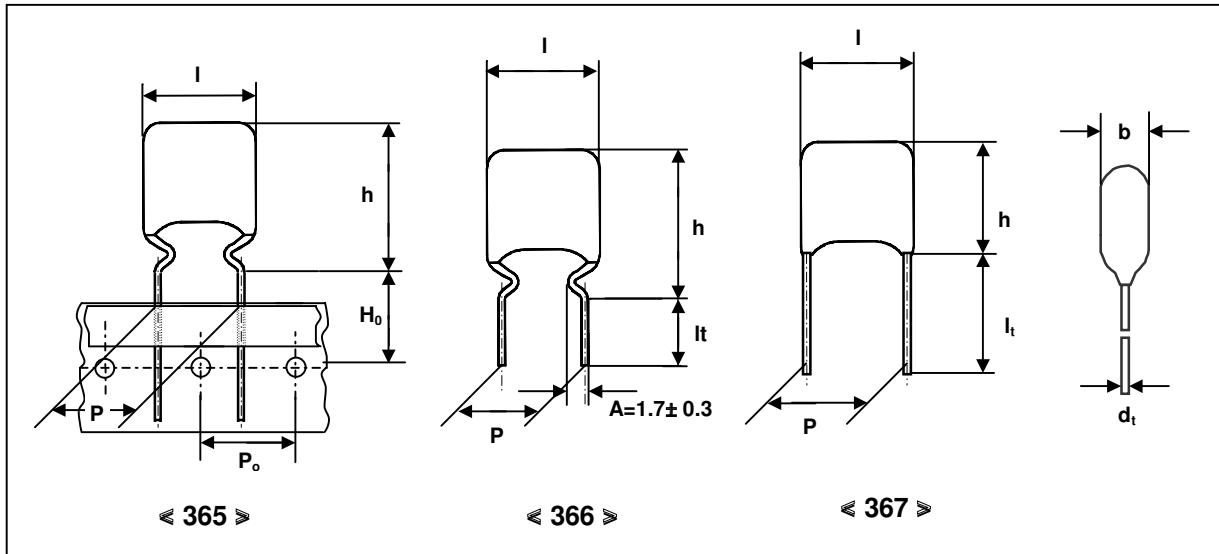

PCMT XXX X X XXX
 Type Series Capacitance

Series
365
366
367

Code	I_{max}	Voltage
1	10.0	63V
2		100V
4		250V
5		400V
6	7.5	630V
7		63V
8		100V

Available versions						Product(I_{max})	
Series	Code	Packing Method	C-tol.	Lead length & Height	Hole to hole (P_0)	7.5	10.0
						Pitch (P)	
365	1	Taped on reel	$\pm 10\%$	$H_0 = 16\text{mm}$	12.7mm	5.08	5.08
	2	Taped on reel	$\pm 5\%$	$H_0 = 16\text{mm}$	12.7mm	5.08	5.08
	5	Ammopack	$\pm 10\%$	$H_0 = 16\text{mm}$	12.7mm	5.08	5.08
	6	Ammopack	$\pm 5\%$	$H_0 = 16\text{mm}$	12.7mm	5.08	5.08
366	1	Loose in box	$\pm 10\%$	$l_t = 17 \pm 4\text{mm}$	-	5.08	7.62
	2	Loose in box	$\pm 5\%$	$l_t = 17 \pm 4\text{mm}$	-	5.08	7.62
	5	Loose in box	$\pm 10\%$	$l_t = 4 + 1/-0.5\text{mm}$	-	5.08	7.62
	6	Loose in box	$\pm 5\%$	$l_t = 4 + 1/-0.5\text{mm}$	-	5.08	7.62
367	1	Loose in box	$\pm 10\%$	$l_t = 22 \pm 4\text{mm}$	-	5.08	7.62
	2	Loose in box	$\pm 5\%$	$l_t = 22 \pm 4\text{mm}$	-	5.08	7.62
	5	Loose in box	$\pm 10\%$	$l_t = 4 + 1/-0.5\text{mm}$	-	5.08	7.62
	6	Loose in box	$\pm 5\%$	$l_t = 4 + 1/-0.5\text{mm}$	-	5.08	7.62

Packing Information

SERIES	SMALLEST PACKAGING QUANTITIES (SPQ)	reel	ammopack
	DIMENSIONS	SPQ	SPQ
365	3.5 x 12.5 x 7.5	1500	1500
	4.0 x 13.0 x 7.5	1500	1500
	4.5 x 13.5 x 7.5	1000	1000
	5.0 x 14.0 x 7.5	1000	1000
	5.5 x 14.5 x 7.5	1000	1000
	6.0 x 15.0 x 7.5	1000	1000
	6.0 x 15.5 x 7.5	1000	1000
	4.0 x 13.5 x 10.0	1500	1500
	4.0 x 15.0 x 10.0	1500	1500
	4.5 x 14.0 x 10.0	1000	1000
	4.5 x 14.0 x 10.5	1000	1000
	4.5 x 15.5 x 10.0	1000	1000
	5.0 x 14.5 x 10.0	1000	1000
	5.0 x 14.5 x 10.5	1000	1000
	5.0 x 16.0 x 10.0	1000	1000
	5.5 x 15.0 x 10.0	1000	1000
	5.5 x 15.0 x 10.5	1000	1000
	5.5 x 16.5 x 10.0	1000	1000
	6.0 x 15.5 x 10.0	1000	1000
	6.0 x 15.5 x 10.5	1000	1000
6.0 x 16.5 x 10.0	1000	1000	
6.5 x 17.0 x 10.0	1000	1000	

SERIES	SMALLEST PACKAGING QUANTITIES (SPQ)	It = 17± 4mm	It = 4+1/-0.5mm
	DIMENSIONS	SPQ	SPQ
366	All dimensions	1000	1000

SERIES	SMALLEST PACKAGING QUANTITIES (SPQ)	It = 22± 4mm	It = 4+1/-0.5mm
	DIMENSIONS	SPQ	SPQ
367	All dimensions	1000	1000

Metallized Polyester film capacitors

PCMT 365

 $V_{Rdc} = 63 V$ $V_{Rac} = 40 V$

taped versions

Cap (□)	$b_{max} \times h_{max} \times l_{max}$ (mm)	mass (g)	CATALOGUE NUMBER			
			PCMT 365			
			taped on reel		ammopack	
			H = 16 mm		H = 16 mm	
			C-tol. ± 10%	C-tol. ± 5%	C-tol. ± 10%	C-tol. ± 5%
Pitch = 5.08 ± 0.3 mm			dt = 0.5 mm (+ 0.05 / - 0.05)			
0.047	3.5 x 12.5 x 7.5	0.3	71473	72473	75473	76473
0.056			71563	72563	75563	76563
0.068			71683	72683	75683	76683
0.082			71823	72823	75823	76823
0.1			71104	72104	75104	76104
0.12			71124	72124	75124	76124
0.15			4.0 x 13.0 x 7.5	0.3	71154	72154
0.18	4.5 x 13.5 x 7.5	0.3	71184	72184	75184	76184
0.22			71224	72224	75224	76224
0.27	5.0 x 14.0 x 7.5	0.4	71274	72274	75274	76274
0.33	5.5 x 14.5 x 7.5	0.4	71334	72334	75334	76334
0.39			71394	72394	75394	76394
0.47	6.0 x 15.5 x 7.5	0.4	71474	72474	75474	76474
0.56	5.5 x 14.0 x 7.5	0.4	71564	72564	75564	76564
0.68	5.5 x 14.5 x 7.5	0.4	71684	72684	75684	76684
0.82	6.0 x 15.0 x 7.5	0.5	71824	72824	75824	76824
1.0	6.0 x 15.5 x 7.5	0.5	71105	72105	75105	76105

SPECIFIC REFERENCE DATA FOR THE 63V DC CAPACITORS

Description	Value		
	at 1kHz	at 10kHz	at 100kHz
Tangent of loss angle (unit : 10^{-4})			
$C \leq 0.1 \mu F$	≤ 75	≤ 130	≤ 225
$0.1 \mu F \leq C \leq 0.47 \mu F$	≤ 75	≤ 130	≤ 300
$0.47 \mu F \leq C \leq 1.0 \mu F$	≤ 75	≤ 130	-
Rated voltage pulse slope $(dV/dt)_R$ at 63V (DC)	110 V/ μF		
R between leads at 10V , for $C \leq 0.33 \mu F$	μF 15 000 μF		
RC between leads at 10V, for $C \leq 0.33 \mu F$	μF 5 000 s		
R between interconnected leads and casing; 100V ; 1min	μF 30 000 μF		
Withstanding voltage DC (cut off current 10mA) ; rise time 100 V/s	100V ; 1min		

**Metallized Polyester
film capacitors**

PCMT 365

Cap (□)	$b_{max} \times h_{max} \times l_{max}$ (mm)	mass (g)	taped versions			
			CATALOGUE NUMBER			
			PCMT 365			
			taped on reel		ammopack	
			H = 16 mm		H = 16 mm	
			C-tol. ± 10%	C-tol. ± 5%	C-tol. ± 10%	C-tol. ± 5%
Pitch = 5.08 ± 0.3 mm			dt = 0.5 mm (+ 0.05 / - 0.05)			
0.01	3.5 x 12.5 x 7.5	0.3	81103	82103	85103	86103
0.012			81123	82123	85123	86123
0.015			81153	82153	85153	86153
0.018			81183	82183	85183	86183
0.022			81223	82223	85223	86223
0.027			81273	82273	85273	86273
0.033			81333	82333	85333	86333
0.039			81393	82393	85393	86393
0.047			81473	82473	85473	86473
0.056			81563	82563	85563	86563
0.068			81683	82683	85683	86683
0.082	4.0 x 13.0 x 7.5	0.3	81823	82823	85823	86823
0.1			81104	82104	85104	86104

SPECIFIC REFERENCE DATA FOR THE 100V DC CAPACITORS

Description	Value		
Tangent of loss angle (unit : 10 ⁻⁴) C ≤ 0.1□ 0.1□ ≤ C ≤ 0.27□	at 1kHz	at 10kHz	at 100kHz
	≤ 75	≤ 130	≤ 225
	≤ 75	≤ 130	≤ 300
Rated voltage pulse slope(dV/dt) _R at 100V (DC)	110 V/□		
R between leads at 100V, for C ≤ 0.33□	□ 15 000 □		
R between interconnected leads and casing;100V ; 1min	□ 30 000□		
Withstanding voltage DC (cut off current 10mA) ;rise time 100 V/s	160V ; 1min		

**Metallized Polyester
film capacitors**

PCMT 365

Cap (□)	$b_{\max} \times h_{\max} \times l_{\max}$ (mm)	mass (g)	taped versions			
			CATALOGUE NUMBER			
			PCMT 365			
			taped on reel		ammopack	
H = 16 mm		H = 16 mm				
C-tol. ± 10%	C-tol. ± 5%	C-tol. ± 10%	C-tol. ± 5%			
Pitch = 5.08 ± 0.3 mm dt = 0.5 mm (+ 0.05 / - 0.05)						
0.12	4.0 x 13.5 x 10.0	0.4	11124	12124	15124	16124
0.15			11154	12154	15154	16154
0.18			11184	12184	15184	16184
0.22			11224	12224	15224	16224
0.27	4.5 x 14.0 x 10.0	0.5	11274	12274	15274	16274
0.33	5.0 x 14.5 x 10.0	0.6	11334	12334	15334	16334
0.39			11394	12394	15394	16394
0.47	5.5 x 15.0 x 10.0	0.7	11474	12474	15474	16474
0.56			11564	12564	15564	16564
0.68			11684	12684	15684	16684
0.82			11824	12824	15824	16824
1.0			11105	12105	15105	16105

SPECIFIC REFERENCE DATA FOR THE 63V DC CAPACITORS

Description	Value		
	at 1kHz	at 10kHz	at 100kHz
Tangent of loss angle (unit : 10 ⁻⁴) C ≤ 0.1□	≤ 75	≤ 130	≤ 225
0.1□ ≤ C ≤ 0.47□	≤ 75	≤ 130	≤ 300
0.47□ □ C ≤ 1.0□	≤ 75	≤ 130	-
Rated voltage pulse slope(dV/dt) _R at 63V (DC)	18 V/□		
R between leads at 10V , for C ≤ 0.33□	□ 15 000 □		
RC between leads at 10V, for C □ 0.33□	□ 5 000 s		
R between interconnected leads and casing;100V ; 1min	□ 30 000 □		
Withstanding voltage DC (cut off current 10mA);rise time 100 V/s	100V ; 1min		

Metallized Polyester film capacitors

PCMT 365

$V_{Rdc} = 100 V$		$V_{Rac} = 63 V \sim$		taped versions			
Cap (□)	$b_{max} \times h_{max} \times l_{max}$ (mm)	mass (g)	CATALOGUE NUMBER				
			PCMT 365				
			taped on reel		ammopack		
			H = 16 mm		H = 16 mm		
				C-tol. ± 10%	C-tol. ± 5%	C-tol. ± 10%	C-tol. ± 5%
Pitch = 5.08 ± 0.3 mm dt = 0.5 mm (+ 0.05 / - 0.05)							
0.039	4.0 x 13.5 x 10.0	0.4	21393	22393	25393	26393	
0.047			21473	22473	25473	26473	
0.056			21563	22563	25563	26563	
0.068			21683	22683	25683	26683	
0.082			21823	22823	25823	26823	
0.1			21104	22104	25104	26104	
0.12	4.5 x 14.0 x 10.5	0.5	21124	22124	25124	26124	
0.15	5.0 x 14.5 x 10.5	0.6	21154	22154	25154	26154	
0.18			21184	22184	25184	26184	
0.22	5.5 x 15.0 x 10.5	0.7	21224	22224	25224	26224	
0.27	6.0 x 15.5 x 10.5	0.7	21274	22274	25274	26274	
0.33			21334	22334	25334	26334	
0.39			21394	22394	25394	26394	
0.47			21474	22474	25474	26474	

SPECIFIC REFERENCE DATA FOR THE 100V DC CAPACITORS

Description	Value		
	at 1kHz	at 10kHz	at 100kHz
Tangent of loss angle (unit : 10^{-4}) $C \leq 0.1 \square$	≤ 75	≤ 130	≤ 225
$0.1 \square \leq C \leq 0.47 \square$	≤ 75	≤ 130	≤ 300
Rated voltage pulse slope $(dV/dt)_R$ at 63V (DC)	36 V/ \square		
R between leads at 10V, for $C \leq 0.33 \square$	\square 15 000 \square		
RC between leads at 10V, for $C \square 0.33 \square$	\square 5 000 s		
R between interconnected leads and casing; 100V ; 1min	\square 30 000 \square		
Withstanding voltage DC (cut off current 10mA) ;rise time 100 V/s	160V ; 1min		

Metallized Polyester film capacitors

PCMT 365

$V_{Rdc} = 250 V$		$V_{Rac} = 160 V \sim$		taped versions			
Cap (□)	$b_{max} \times h_{max} \times l_{max}$ (mm)	mass (g)	CATALOGUE NUMBER				
			PCMT 365				
			taped on reel		ammopack		
			H = 16 mm		H = 16 mm		
			C-tol. ± 10%	C-tol. ± 5%	C-tol. ± 10%	C-tol. ± 5%	
Pitch = 5.08 ± 0.3 mm dt = 0.5 mm (+ 0.05 / - 0.05)							
0.018	4.0 x 13.5 x 10.0	0.4	41183	42183	45183	46183	
0.022			41223	42223	45223	46223	
0.027			41273	42273	45273	46273	
0.033			41333	42333	45333	46333	
0.039			41393	42393	45393	46393	
0.047			41473	42473	45473	46473	
0.056			41563	42563	45563	46563	
0.068			41683	42683	45683	46683	
0.082	5.0 x 14.5 x 10.5	0.4	41823	42823	45823	46823	
0.1			41104	42104	45104	46104	
0.12	5.5 x 15.0 x 10.5	0.6	41124	42124	45124	46124	
0.15	5.5 x 15.5 x 10.5	0.7	41154	42154	45154	46154	

SPECIFIC REFERENCE DATA FOR THE 250V DC CAPACITORS

Description	Value		
	at 1kHz	at 10kHz	at 100kHz
Tangent of loss angle (unit : 10^{-4}) $C \leq 0.1 \square$	≤ 75	≤ 130	≤ 225
Rated voltage pulse slope $(dV/dt)_R$ at 100V (DC)	70 V/□		
R between leads at 100V, for $C \leq 0.33 \square$	□ 30 000 □		
R between interconnected leads and casing; 100V ; 1min	□ 30 000 □		
Withstanding voltage DC (cut off current 10mA) ; rise time 100 V/s	400V ; 1min		

Metallized Polyester film capacitors

PCMT 365

$V_{Rdc} = 400 V$		$V_{Rac} = 220 V \sim$		taped versions			
Cap (□)	$b_{max} \times h_{max} \times l_{max}$ (mm)	mass (g)	CATALOGUE NUMBER				
			PCMT 365				
			taped on reel		ammopack		
			H = 16 mm		H = 16 mm		
			C-tol. ± 10%	C-tol. ± 5%	C-tol. ± 10%	C-tol. ± 5%	
Pitch = 5.08 ± 0.3 mm dt = 0.5 mm (+ 0.05 / - 0.05)							
0.0010	4.0 x 13.5 x 10.0	0.4	51102	52102	55102	56102	
0.0012			51122	52122	55122	56122	
0.0015			51152	52152	55152	56152	
0.0018			51182	52182	55182	56182	
0.0022			51222	52222	55222	56222	
0.0027			51272	52272	55272	56272	
0.0033			51332	52332	55332	56332	
0.0039			51392	52392	55392	56392	
0.0047			51472	52472	55472	56472	
0.0056			51562	52562	55562	56562	
0.0068			51682	52682	55682	56682	
0.0082			51822	52822	55822	56822	
0.010			51103	52103	55103	56103	
0.012			51123	52123	55123	56123	
0.015			51153	52153	55153	56153	
0.018			4.0 x 15.0 x 10.0	0.4	51183	52183	55183
0.022	4.5 x 15.5 x 10.0	0.4	51223	52223	55223	56223	
0.027	5.0 x 16.0 x 10.0	0.4	51273	52273	55273	56273	
0.033	5.5 x 16.5 x 10.0	0.4	51333	52333	55333	56333	
0.039	6.0 x 16.5 x 10.0	0.4	51393	52393	55393	56393	
0.047	6.5 x 17.0 x 10.0	0.4	51473	52473	55473	56473	
0.056			51563	52563	55563	56563	

SPECIFIC REFERENCE DATA FOR THE 400V DC CAPACITORS

Description	Value		
	at 1kHz	at 10kHz	at 100kHz
Tangent of loss angle (unit : 10^{-4}) $C \leq 0.1 \square$	≤ 75	≤ 130	≤ 225
Rated voltage pulse slope $(dV/dt)_R$ at 100V (DC)	110 V/□		
R between leads at 100V, for $C \leq 0.33 \square$	□ 30 000 □		
R between interconnected leads and casing; 100V ; 1min	□ 30 000 □		
Withstanding voltage DC (cut off current 10mA) ; rise time 100 V/s	640V ; 1min		

Metallized Polyester film capacitors

PCMT 365

 $V_{Rdc} = 630 V$ $V_{Rac} = 250 V \sim$

taped versions

Cap (□)	$b_{max} \times h_{max} \times l_{max}$ (mm)	mass (g)	CATALOGUE NUMBER					
			PCMT 365					
			taped on reel		ammopack			
			H = 16 mm		H = 16 mm			
			C-tol. ± 10%	C-tol. ± 5%	C-tol. ± 10%	C-tol. ± 5%		
Pitch = 5.08 ± 0.3 mm dt = 0.5 mm (+ 0.05 / - 0.05)								
0.0010	4.0 x 13.5 x 10.0	0.4	61102	62102	65102	66102		
0.0012			61122	62122	65122	66122		
0.0015			61152	62152	65152	66152		
0.0018			61182	62182	65182	66182		
0.0022			61222	62222	65222	66222		
0.0027			61272	62272	65272	66272		
0.0033			61332	62332	65332	66332		
0.0039			61392	62392	65392	66392		
0.0047			61472	62472	65472	66472		
0.0056			61562	62562	65562	66562		
0.0068			61682	62682	65682	66682		
0.0082			61822	62822	65822	66822		
0.010			5.0 x 14.5 x 10.0	0.4	61103	62103	65103	66103
0.012			5.5 x 15.0 x 10.0	0.4	61123	62123	65123	66123
0.015	6.0 x 15.5 x 10.0	0.5	61153	62153	65153	66153		

SPECIFIC REFERENCE DATA FOR THE 630V DC CAPACITORS

Description	Value		
	at 1kHz	at 10kHz	at 100kHz
Tangent of loss angle (unit : 10^{-4}) $C \leq 0.1 \square$	≤ 75	≤ 130	≤ 225
Rated voltage pulse slope $(dV/dt)_R$ at 100V (DC)	110 V/ \square		
R between leads at 100V, for $C \leq 0.33 \square$	\square 30 000 \square		
R between interconnected leads and casing; 100V ; 1min	\square 30 000 \square		
Withstanding voltage DC (cut off current 10mA) ; rise time 100 V/s	1008V ; 1min		

**Metallized Polyester
film capacitors**

PCMT 366

 $V_{Rdc} = 63 V$ $V_{Rac} = 40 V \sim$

loose in box

Cap (□)	$b_{max} \times h_{max} \times l_{max}$ (mm)	mass (g)	CATALOGUE NUMBER			
			PCMT 366			
			loose in box			
			It = 17 ± 4 mm		It = 4 +1/-0.5 mm	
			C-tol. ± 10%	C-tol. ± 5%	C-tol. ± 10%	C-tol. ± 5%
Pitch = 5.08 ± 0.3 mm dt = 0.5 mm (+ 0.05 / - 0.05)						
0.047	3.5 x 12.5 x 7.5	0.3	71473	72473	75473	76473
0.056			71563	72563	75563	76563
0.068			71683	72683	75683	76683
0.082			71823	72823	75823	76823
0.1			71104	72104	75104	76104
0.12			71124	72124	75124	76124
0.15	4.0 x 13.0 x 7.5	0.3	71154	72154	75154	76154
0.18	4.5 x 13.5 x 7.5	0.3	71184	72184	75184	76184
0.22			71224	72224	75224	76224
0.27	5.0 x 14.0 x 7.5	0.4	71274	72274	75274	76274
0.33	5.5 x 14.5 x 7.5	0.4	71334	72334	75334	76334
0.39			71394	72394	75394	76394
0.47	6.0 x 15.5 x 7.5	0.4	71474	72474	75474	76474
0.56	5.5 x 14.0 x 7.5	0.4	71564	72564	75564	76564
0.68	5.5 x 14.5 x 7.5	0.4	71684	72684	75684	76684
0.82	6.0 x 15.0 x 7.5	0.5	71824	72824	75824	76824
1.0	6.5 x 15.5 x 7.5	0.5	71105	72105	75105	76105

SPECIFIC REFERENCE DATA FOR THE 63V DC CAPACITORS

Description	Value		
	at 1kHz	at 10kHz	at 100kHz
Tangent of loss angle (unit : 10^{-4})			
$C \leq 0.1 \square$	≤ 75	≤ 130	≤ 225
$0.1 \square \leq C \leq 0.47 \square$	≤ 75	≤ 130	≤ 300
$0.47 \square \leq C \leq 1.0 \square$	≤ 75	≤ 130	-
Rated voltage pulse slope $(dV/dt)_R$ at 63V (DC)	110 V/ \square		
R between leads at 10V , for $C \leq 0.33 \square$	\square 15 000 \square		
RC between leads at 10V, for $C \square 0.33 \square$	\square 5 000 s		
R between interconnected leads and casing;100V ; 1min	\square 30 000 \square		
Withstanding voltage DC (cut off current 10mA) ;rise time 100 V/s	100V ; 1min		

**Metallized Polyester
film capacitors**

PCMT 366

$V_{Rdc} = 100\text{ V}$		$V_{Rac} = 63\text{ V} \sim$		loose in box			
Cap (□)	$b_{max} \times h_{max} \times l_{max}$ (mm)	mass (g)	CATALOGUE NUMBER				
			PCMT 366				
			loose in box				
			It = 17 ± 4 mm		It = 4 +1/-0.5 mm		
			C-tol. ± 10%	C-tol. ± 5%	C-tol. ± 10%	C-tol. ± 5%	
Pitch = 5.08 ± 0.3 mm dt = 0.5 mm (+ 0.05 / - 0.05)							
0.01	3.5 x 12.5 x 7.5	0.3	81103	82103	85103	86103	
0.012			81123	82123	85123	86123	
0.015			81153	82153	85153	86153	
0.018			81183	82183	85183	86183	
0.022			81223	82223	85223	86223	
0.027			81273	82273	85273	86273	
0.033			81333	82333	85333	86333	
0.039			81393	82393	85393	86393	
0.047			81473	82473	85473	86473	
0.056			81563	82563	85563	86563	
0.068			81683	82683	85683	86683	
0.082	4.0 x 13.0 x 7.5	0.3	81823	82823	85823	86823	
0.1			81104	82104	85104	86104	

SPECIFIC REFERENCE DATA FOR THE 100V DC CAPACITORS

Description	Value		
	at 1kHz	at 10kHz	at 100kHz
Tangent of loss angle (unit : 10^{-4})			
$C \leq 0.1\mu\text{F}$	≤ 75	≤ 130	≤ 225
$0.1\mu\text{F} \leq C \leq 0.27\mu\text{F}$	≤ 75	≤ 130	≤ 300
Rated voltage pulse slope $(dV/dt)_R$ at 100V (DC)	110 V/ μs		
R between leads at 100V, for $C \leq 0.33\mu\text{F}$	μs 15 000 μs		
R between interconnected leads and casing; 100V ; 1 min	μs 30 000 μs		
Withstanding voltage DC (cut off current 10mA); rise time 100 V/s	160V ; 1min		

**Metallized Polyester
film capacitors**

PCMT 366

 $V_{Rdc} = 63 V$ $V_{Rac} = 40 V \sim$

loose in box

Cap (□)	$b_{max} \times h_{max} \times l_{max}$ (mm)	mass (g)	CATALOGUE NUMBER			
			PCMT 366			
			loose in box			
			It = 17 ± 4 mm		It = 4 +1/-0.5 mm	
		C-tol. ± 10%	C-tol. ± 5%	C-tol. ± 10%	C-tol. ± 5%	
Pitch = 7.62 ± 0.3 mm dt = 0.5 mm (+ 0.05 / - 0.05)						
0.12	4.0 x 12.0 x 10.0	0.4	11124	12124	15124	16124
0.15			11154	12154	15154	16154
0.18			11184	12184	15184	16184
0.22			11224	12224	15224	16224
0.27	4.5 x 13.0 x 10.5	0.5	11274	12274	15274	16274
0.33	5.0 x 13.5 x 10.5	0.6	11334	12334	15334	16334
0.39			11394	12394	15394	16394
0.47	5.5 x 14.0 x 10.5	0.7	11474	12474	15474	16474
0.56	5.5 x 14.5 x 10.5	0.8	11564	12564	15564	16564
0.68			11684	12684	15684	16684
0.82			11824	12824	15824	16824
1.0			11105	12105	15105	16105

SPECIFIC REFERENCE DATA FOR THE 63V DC CAPACITORS

Description	Value		
	at 1kHz	at 10kHz	at 100kHz
Tangent of loss angle (unit : 10 ⁻⁴)			
C ≤ 0.1□	≤ 75	≤ 130	≤ 225
0.1□ ≤ C ≤ 0.47□	≤ 75	≤ 130	≤ 300
0.47□ □ C ≤ 1.0□	≤ 75	≤ 130	-
Rated voltage pulse slope(dV/dt) _R at 63V (DC)	18 V/□		
R between leads at 10V , for C ≤ 0.33□	□ 15 000 □		
RC between leads at 10V, for C □ 0.33□	□ 5 000 s		
R between interconnected leads and casing;100V ; 1min	□ 30 000 □		
Withstanding voltage DC (cut off current 10mA) ;rise time 100 V/s	100V ; 1min		

**Metallized Polyester
film capacitors**

PCMT 366

 $V_{Rdc} = 100\text{ V}$ $V_{Rac} = 63\text{ V}$

loose in box

Cap (□)	$b_{max} \times h_{max} \times l_{max}$ (mm)	mass (g)	CATALOGUE NUMBER			
			PCMT 366			
			loose in box			
			lt = 17 ± 4 mm		lt = 4 +1/-0.5 mm	
		C-tol. ± 10%	C-tol. ± 5%	C-tol. ± 10%	C-tol. ± 5%	
Pitch = 7.62 ± 0.3 mm dt = 0.5 mm (+ 0.05 / - 0.05)						
0.039	4.0 x 12.0 x 10.0	0.4	21393	22393	25393	26393
0.047			21473	22473	25473	26473
0.056			21563	22563	25563	26563
0.068			21683	22683	25683	26683
0.082			21823	22823	25823	26823
0.10	4.0 x 13.0 x 10.0	0.4	21104	22104	25104	26104
0.12	4.5 x 13.0 x 10.5	0.5	21124	22124	25124	26124
0.15	5.0 x 13.0 x 10.5	0.5	21154	22154	25154	26154
0.18	5.0 x 13.5 x 10.5	0.6	21184	22184	25184	26184
0.22	5.5 x 13.5 x 10.5	0.7	21224	22224	25224	26224
0.27	6.0 x 14.5 x 10.5	0.7	21274	22274	25274	26274
0.33	6.0 x 15.0 x 10.5	0.7	21334	22334	25334	26334
0.39			21394	22394	25394	26394
0.47			21474	22474	25474	26474

SPECIFIC REFERENCE DATA FOR THE 100V DC CAPACITORS

Description	Value		
	at 1kHz	at 10kHz	at 100kHz
Tangent of loss angle (unit : 10^{-4})			
$C \leq 0.1\mu$	≤ 75	≤ 130	≤ 225
$0.1\mu \leq C \leq 0.47\mu$	≤ 75	≤ 130	≤ 300
Rated voltage pulse slope $(dV/dt)_R$ at 100V (DC)	36 V/ μ		
R between leads at 100V, for $C \leq 0.33\mu$	μ 15 000 μ		
RC between leads at 100V, for $C \leq 0.33\mu$	μ 5 000 s		
R between interconnected leads and casing;100V ; 1min	μ 30 000 μ		
Withstanding voltage DC (cut off current 10mA) ;rise time 100 V/s	160V ; 1min		

**Metallized Polyester
film capacitors**

PCMT 366

$V_{Rdc} = 250 V$		$V_{Rac} = 160 V \sim$		loose in box			
Cap (□)	$b_{max} \times h_{max} \times l_{max}$ (mm)	mass (g)	CATALOGUE NUMBER				
			PCMT 366				
			loose in box				
			lt = 17 ± 4 mm		lt = 4 +1/-0.5 mm		
		C-tol. ± 10%	C-tol. ± 5%	C-tol. ± 10%	C-tol. ± 5%		
Pitch = 7.62 ± 0.3 mm dt = 0.5 mm (+ 0.05 / - 0.05)							
0.018	4.0 x 13.0 x 10.0	0.4	41183	42183	45183	46183	
0.022			41223	42223	45223	46223	
0.027			41273	42273	45273	46273	
0.033			41333	42333	45333	46333	
0.039			41393	42393	45393	46393	
0.047			41473	42473	45473	46473	
0.056			41563	42563	45563	46563	
0.068			41683	42683	45683	46683	
0.082	5.0 x 14.0 x 10.5	0.4	41823	42823	45823	46823	
0.1			41104	42104	45104	46104	
0.12	5.5 x 15.0 x 10.5	0.6	41124	42124	45124	46124	
0.15	5.5 x 15.5 x 10.5	0.7	41154	42154	45154	46154	

SPECIFIC REFERENCE DATA FOR THE 250V DC CAPACITORS

Description	Value		
	at 1kHz	at 10kHz	at 100kHz
Tangent of loss angle (unit : 10^{-4}) $C \leq 0.1 \mu F$	≤ 75	≤ 130	≤ 225
Rated voltage pulse slope $(dV/dt)_R$ at 100V (DC)	70 V/ μF		
R between leads at 100V, for $C \leq 0.33 \mu F$	□ 30 000 □		
R between interconnected leads and casing; 100V ; 1min	□ 30 000 □		
Withstanding voltage DC (cut off current 10mA) ;rise time 100 V/s	400V ; 1min		

**Metallized Polyester
film capacitors**

PCMT 366

$V_{Rdc} = 400 V$		$V_{Rac} = 220 V \sim$		loose in box			
Cap (□)	$b_{max} \times h_{max} \times l_{max}$ (mm)	mass (g)	CATALOGUE NUMBER				
			PCMT 366				
			loose in box				
			lt = 17 ± 4 mm		lt = 4 +1/-0.5 mm		
		C-tol. ± 10%	C-tol. ± 5%	C-tol. ± 10%	C-tol. ± 5%		
Pitch = 7.62 ± 0.3 mm dt = 0.5 mm (+ 0.05 / - 0.05)							
0.0010	4.0 x 13.5 x 10.0	0.4	51102	52102	55102	56102	
0.0012			51122	52122	55122	56122	
0.0015			51152	52152	55152	56152	
0.0018			51182	52182	55182	56182	
0.0022			51222	52222	55222	56222	
0.0027			51272	52272	55272	56272	
0.0033			4.0 x 12.0 x 10.0	0.4	51332	52332	55332
0.0039	51392	52392			55392	56392	
0.0047	51472	52472			55472	56472	
0.0056	4.0 x 13.0 x 10.0	0.4	51562	52562	55562	56562	
0.0068			51682	52682	55682	56682	
0.0082			51822	52822	55822	56822	
0.010			51103	52103	55103	56103	
0.012			51123	52123	55123	56123	
0.015			51153	52153	55153	56153	
0.018			4.0 x 15.0 x 10.0	0.4	51183	52183	55183
0.022	4.5 x 15.5 x 10.0	0.4	51223	52223	55223	56223	
0.027	5.0 x 16.0 x 10.0	0.4	51273	52273	55273	56273	
0.033	5.5 x 16.5 x 10.0	0.4	51333	52333	55333	56333	
0.039	6.0 x 16.5 x 10.0	0.4	51393	52393	55393	56393	
0.047	6.5 x 17.0 x 10.0	0.4	51473	52473	55473	56473	
0.056	6.5 x 17.0 x 10.0	0.4	51563	52563	55563	56563	

SPECIFIC REFERENCE DATA FOR THE 400V DC CAPACITORS

Description	Value		
	at 1kHz	at 10kHz	at 100kHz
Tangent of loss angle (unit : 10^{-4}) $C \leq 0.1 \square$	≤ 75	≤ 130	≤ 225
Rated voltage pulse slope $(dV/dt)_R$ at 100V (DC)	110 V/□		
R between leads at 100V, for $C \leq 0.33 \square$	□ 30 000 □		
R between interconnected leads and casing; 100V ; 1min	□ 30 000 □		
Withstanding voltage DC (cut off current 10mA) ; rise time 100 V/s	640V ; 1min		

**Metallized Polyester
film capacitors**

PCMT 366

 $V_{Rdc} = 630 V$ $V_{Rac} = 250 V \sim$

loose in box

Cap (□)	$b_{max} \times h_{max} \times l_{max}$ (mm)	mass (g)	CATALOGUE NUMBER					
			PCMT 366					
			loose in box					
			lt = 17 ± 4 mm		lt = 4 +1/-0.5 mm			
C-tol. ± 10%		C-tol. ± 5%		C-tol. ± 10%		C-tol. ± 5%		
Pitch = 7.62 ± 0.3 mm dt = 0.5 mm (+ 0.05 / - 0.05)								
0.0010	4.0 x 13.5 x 10.0	0.4	61102	62102	65102	66102		
0.0012			61122	62122	65122	66122		
0.0015			61152	62152	65152	66152		
0.0018			61182	62182	65182	66182		
0.0022			61222	62222	65222	66222		
0.0027			61272	62272	65272	66272		
0.0033			61332	62332	65332	66332		
0.0039			61392	62392	65392	66392		
0.0047			61472	62472	65472	66472		
0.0056			61562	62562	65562	66562		
0.0068			61682	62682	65682	66682		
0.0082			61822	62822	65822	66822		
0.010			5.0 x 14.5 x 10.0	0.4	61103	62103	65103	66103
0.012			5.5 x 15.0 x 10.0	0.4	61123	62123	65123	66123
0.015	6.0 x 15.5 x 10.0	0.5	61153	62153	65153	66153		

SPECIFIC REFERENCE DATA FOR THE 630V DC CAPACITORS

Description	Value		
	at 1kHz	at 10kHz	at 100kHz
Tangent of loss angle (unit : 10^{-4}) $C \leq 0.1 \square$	≤ 75	≤ 130	≤ 225
Rated voltage pulse slope(dV/dt) _R at 100V (DC)	110 V/□		
R between leads at 100V, for $C \leq 0.33 \square$	□ 30 000 □		
R between interconnected leads and casing;100V ; 1min	□ 30 000 □		
Withstanding voltage DC (cut off current 10mA) ;rise time 100 V/s	1008V ; 1min		

**Metallized Polyester
film capacitors**

PCMT 367

 $V_{Rdc} = 63 V$ $V_{Rac} = 40 V \sim$

loose in box

Cap (□)	$b_{max} \times h_{max} \times l_{max}$ (mm)	mass (g)	CATALOGUE NUMBER			
			PCMT 367			
			loose in box			
			It = 22 ± 4 mm		It = 4 +1/-0.5 mm	
		C-tol. ± 10%	C-tol. ± 5%	C-tol. ± 10%	C-tol. ± 5%	
Pitch = 5.08 ± 0.3 mm dt = 0.5 mm (+ 0.05 / - 0.05)						
0.047	3.5 x 7.5 x 7.5	0.3	71473	72473	75473	76473
0.056			71563	72563	75563	76563
0.068			71683	72683	75683	76683
0.082			71823	72823	75823	76823
0.1			71104	72104	75104	76104
0.12			71124	72124	75124	76124
0.15			4.0 x 8.0 x 7.5	0.3	71154	72154
0.18	4.5 x 8.5 x 7.5	0.3	71184	72184	75184	76184
0.22			71224	72224	75224	76224
0.27	5.0 x 9.0 x 7.5	0.3	71274	72274	75274	76274
0.33	5.5 x 9.5 x 7.5	0.3	71334	72334	75334	76334
0.39	5.5 x 10.5 x 7.5	0.3	71394	72394	75394	76394
0.47	6.0 x 11.5 x 7.5	0.4	71474	72474	75474	76474
0.56	5.5 x 10.0 x 7.5	0.4	71564	72564	75564	76564
0.68	5.5 x 10.5 x 7.5	0.4	71684	72684	75684	76684
0.82	6.0 x 11.0 x 7.5	0.5	71824	72824	75824	76824
1.0	6.5 x 11.5 x 7.5	0.5	71105	72105	75105	76105

SPECIFIC REFERENCE DATA FOR THE 63V DC CAPACITORS

Description	Value		
	at 1kHz	at 10kHz	at 100kHz
Tangent of loss angle (unit : 10^{-4})			
$C \leq 0.1 \square$	≤ 75	≤ 130	≤ 225
$0.1 \square \leq C \leq 0.47 \square$	≤ 75	≤ 130	≤ 300
$0.47 \square \square C \leq 1.0 \square$	≤ 75	≤ 130	-
Rated voltage pulse slope $(dV/dt)_R$ at 63V (DC)	110 V/ \square		
R between leads at 10V , for $C \leq 0.33 \square$	\square 15 000 \square		
RC between leads at 10V, for $C \square 0.33 \square$	\square 5 000 s		
R between interconnected leads and casing;100V ; 1min	\square 30 000 \square		
Withstanding voltage DC (cut off current 10mA) ;rise time 100 V/s	100V ; 1min		

**Metallized Polyester
film capacitors**

PCMT 367

$V_{Rdc} = 100 V$		$V_{Rac} = 63 V \sim$		loose in box			
Cap (□)	$b_{max} \times h_{max} \times l_{max}$ (mm)	mass (g)	CATALOGUE NUMBER				
			PCMT 367				
			loose in box				
			lt = 22 ± 4 mm		lt = 4 +1/-0.5 mm		
			C-tol. ± 10%	C-tol. ± 5%	C-tol. ± 10%	C-tol. ± 5%	
Pitch = 5.08 ± 0.3 mm dt = 0.5 mm (+ 0.05 / - 0.05)							
0.01	3.5 x 7.5 x 7.5	0.3	81103	82103	85103	86103	
0.012			81123	82123	85123	86123	
0.015			81153	82153	85153	86153	
0.018			81183	82183	85183	86183	
0.022			81223	82223	85223	86223	
0.027			81273	82273	85273	86273	
0.033			81333	82333	85333	86333	
0.039			81393	82393	85393	86393	
0.047			81473	82473	85473	86473	
0.056			81563	82563	85563	86563	
0.068			81683	82683	85683	86683	
0.082			4.0 x 8.0 x 7.5	0.3	81823	82823	85823
0.1	81104	82104			85104	86104	

SPECIFIC REFERENCE DATA FOR THE 100V DC CAPACITORS

Description	Value		
	at 1kHz	at 10kHz	at 100kHz
Tangent of loss angle (unit : 10^{-4}) $C \leq 0.1 \square$	≤ 75	≤ 130	≤ 225
$0.1 \square \leq C \leq 0.27 \square$	≤ 75	≤ 130	≤ 300
Rated voltage pulse slope $(dV/dt)_R$ at 100V (DC)	110 V/□		
R between leads at 100V, for $C \leq 0.33 \square$	□ 15 000 □		
R between interconnected leads and casing; 100V ; 1min	□ 30 000 □		
Withstanding voltage DC (cut off current 10mA) ; rise time 100 V/s	160V ; 1min		

**Metallized Polyester
film capacitors**

PCMT 367

 $V_{Rdc} = 63 V$ $V_{Rac} = 40 V \sim$

loose in box

Cap (□)	$b_{max} \times h_{max} \times l_{max}$ (mm)	mass (g)	CATALOGUE NUMBER			
			PCMT 367			
			loose in box			
			lt = 22 ± 4 mm		lt = 4 +1/-0.5 mm	
		C-tol. ± 10%	C-tol. ± 5%	C-tol. ± 10%	C-tol. ± 5%	
Pitch = 7.62 ± 0.3 mm dt = 0.5 mm (+ 0.05 / - 0.05)						
0.12	4.0 x 8.0 x 10.0	0.4	11124	12124	15124	16124
0.15			11154	12154	15154	16154
0.18			11184	12184	15184	16184
0.22			11224	12224	15224	16224
0.27	4.5 x 8.5 x 10.5	0.5	11274	12274	15274	16274
0.33	5.0 x 9.0 x 10.5	0.6	11334	12334	15334	16334
0.39			11394	12394	15394	16394
0.47	5.5 x 9.5 x 10.5	0.7	11474	12474	15474	16474
0.56	5.5 x 10.0 x 10.5	0.8	11564	12564	15564	16564
0.68			11684	12684	15684	16684
0.82			11824	12824	15824	16824
1.0			11105	12105	15105	16105

SPECIFIC REFERENCE DATA FOR THE 63V DC CAPACITORS

Description	Value		
	at 1kHz	at 10kHz	at 100kHz
Tangent of loss angle (unit : 10^{-4})			
$C \leq 0.1 \square$	≤ 75	≤ 130	≤ 225
$0.1 \square \leq C \leq 0.47 \square$	≤ 75	≤ 130	≤ 300
$0.47 \square \square C \leq 1.0 \square$	≤ 75	≤ 130	-
Rated voltage pulse slope(dV/dt) _R at 63V (DC)	18 V/□		
R between leads at 10V , for $C \leq 0.33 \square$	□ 15 000 □		
RC between leads at 10V, for $C \square 0.33 \square$	□ 5 000 s		
R between interconnected leads and casing;100V ; 1min	□ 30 000 □		
Withstanding voltage DC (cut off current 10mA) ;rise time 100 V/s	100V ; 1min		

Metallized Polyester film capacitors

PCMT 367

$V_{Rdc} = 100\text{ V}$		$V_{Rac} = 63\text{ V} \sim$		loose in box			
Cap (□)	$b_{max} \times h_{max} \times l_{max}$ (mm)	mass (g)	CATALOGUE NUMBER				
			PCMT 367				
			loose in box				
			lt = 22 ± 4 mm		lt = 4 +1/□ 0.5 mm		
			C-tol. ± 10%	C-tol. ± 5%	C-tol. ± 10%	C-tol. ± 5%	
Pitch = 7.62 ± 0.3 mm dt = 0.5 mm (+ 0.05 / - 0.05)							
0.039	4.0 x 8.0 x 10.0	0.4	21393	22393	25393	26393	
0.047			21473	22473	25473	26473	
0.056			21563	22563	25563	26563	
0.068			21683	22683	25683	26683	
0.082			21823	22823	25823	26823	
0.10	4.0 x 8.5 x 10.0	0.4	21104	22104	25104	26104	
0.12	4.5 x 9.0 x 10.5	0.5	21124	22124	25124	26124	
0.15	5.0 x 9.5 x 10.5	0.5	21154	22154	25154	26154	
0.18			21184	22184	25184	26184	
0.22	5.5 x 10.0 x 10.5	0.7	21224	22224	25224	26224	
0.27	6.0 x 10.5 x 10.5	0.7	21274	22274	25274	26274	
0.33			21334	22334	25334	26334	
0.39			21394	22394	25394	26394	
0.47			21474	22474	25474	26474	

SPECIFIC REFERENCE DATA FOR THE 100V DC CAPACITORS

Description	Value		
	at 1kHz	at 10kHz	at 100kHz
Tangent of loss angle (unit : 10 ⁻⁴) C ≤ 0.1□ 0.1□ ≤ C ≤ 0.47□	≤ 75 ≤ 75	≤ 130 ≤ 130	≤ 225 ≤ 300
Rated voltage pulse slope(dV/dt) _R at 100V (DC)	36 V/□		
R between leads at 100V, for C ≤ 0.33□	□ 15 000 □		
RC between leads at 100V, for C □ 0.33□	□ 5 000 s		
R between interconnected leads and casing;100V ; 1min	□ 30 000 □		
Withstanding voltage DC (cut off current 10mA) ;rise time 100 V/s	160V ; 1min		

**Metallized Polyester
film capacitors**

PCMT 367

$V_{Rdc} = 250 V$		$V_{Rac} = 160 V \sim$		loose in box			
Cap (□)	$b_{max} \times h_{max} \times l_{max}$ (mm)	mass (g)	CATALOGUE NUMBER				
			PCMT 367.....				
			loose in box				
			It = 22 ± 4 mm		It = 4 +1/-0.5 mm		
			C-tol. ± 10%	C-tol. ± 5%	C-tol. ± 10%	C-tol. ± 5%	
Pitch = 7.62 ± 0.3 mm			dt = 0.5 mm (+ 0.05 / - 0.05)				
0.018	4.0 x 8.5 x 10.0	0.4	41183	42183	45183	46183	
0.022			41223	42223	45223	46223	
0.027			41273	42273	45273	46273	
0.033			41333	42333	45333	46333	
0.039			41393	42393	45393	46393	
0.047			41473	42473	45473	46473	
0.056			41563	42563	45563	46563	
0.068			41683	42683	45683	46683	
0.082	5.0 x 9.5 x 10.5	0.4	41823	42823	45823	46823	
0.1			41104	42104	45104	46104	
0.12	5.5 x 10.0 x 10.5	0.6	41124	42124	45124	46124	
0.15	5.5 x 11.5 x 10.5	0.7	41154	42154	45154	46154	

SPECIFIC REFERENCE DATA FOR THE 250V DC CAPACITORS

Description	Value		
	at 1kHz	at 10kHz	at 100kHz
Tangent of loss angle (unit : 10 ⁻⁴) $C \leq 0.1 \mu F$	≤ 75	≤ 130	≤ 225
Rated voltage pulse slope(dV/dt) _R at 100V (DC)	70 V/μs		
R between leads at 100V, for $C \leq 0.33 \mu F$	□ 30 000 □		
R between interconnected leads and casing;100V ; 1min	□ 30 000 □		
Withstanding voltage DC (cut off current 10mA) ;rise time 100 V/s	400V ; 1min		

**Metallized Polyester
film capacitors**

PCMT 367

$V_{Rdc} = 400 V$		$V_{Rac} = 220 V \sim$		loose in box			
Cap (□)	$b_{max} \times h_{max} \times l_{max}$ (mm)	mass (g)	CATALOGUE NUMBER				
			PCMT 367				
			loose in box				
			lt = 22 ± 4 mm		lt = 4 +1/-0.5 mm		
			C-tol. ± 10%	C-tol. ± 5%	C-tol. ± 10%	C-tol. ± 5%	
Pitch = 7.62 ± 0.3 mm dt = 0.5 mm (+ 0.05 / - 0.05)							
0.0010	4.0 x 8.5 x 10.0	0.4	51102	52102	55102	56102	
0.0012			51122	52122	55122	56122	
0.0015			51152	52152	55152	56152	
0.0018			51182	52182	55182	56182	
0.0022			51222	52222	55222	56222	
0.0027			51272	52272	55272	56272	
0.0033			51332	52332	55332	56332	
0.0039			51392	52392	55392	56392	
0.0047			51472	52472	55472	56472	
0.0056			51562	52562	55562	56562	
0.0068			51682	52682	55682	56682	
0.0082			51822	52822	55822	56822	
0.010			51103	52103	55103	56103	
0.012			51123	52123	55123	56123	
0.015			51153	52153	55153	56153	
0.018	4.0 x 10.0 x 10.0	0.4	51183	52183	55183	56183	
0.022	4.5 x 10.5 x 10.0	0.4	51223	52223	55223	56223	
0.027	5.0 x 11.0 x 10.0	0.4	51273	52273	55273	56273	
0.033	5.5 x 11.5 x 10.0	0.4	51333	52333	55333	56333	
0.039	6.0 x 11.5 x 10.0	0.4	51393	52393	55393	56393	
0.047	6.5 x 12.0 x 10.0	0.4	51473	52473	55473	56473	
0.056	6.5 x 12.0 x 10.0	0.4	51563	52563	55563	56563	

SPECIFIC REFERENCE DATA FOR THE 400V DC CAPACITORS

Description	Value		
	at 1kHz	at 10kHz	at 100kHz
Tangent of loss angle (unit : 10 ⁻⁴) C ≤ 0.1□	≤ 75	≤ 130	≤ 225
Rated voltage pulse slope(dV/dt) _R at 100V (DC)	110 V/□		
R between leads at 100V, for C ≤ 0.33□	□ 30 000 □		
R between interconnected leads and casing;100V ; 1min	□ 30 000 □		
Withstanding voltage DC (cut off current 10mA) ;rise time 100 V/s	640V ; 1min		

Metallized Polyester film capacitors

PCMT 367

$V_{Rdc} = 630 V$		$V_{Rac} = 250 V \sim$		loose in box				
Cap (□)	$b_{max} \times h_{max} \times l_{max}$ (mm)	mass (g)	CATALOGUE NUMBER					
			PCMT 367					
			loose in box					
			lt = 22 ± 4 mm		lt = 4 +1/-0.5 mm			
		C-tol. ± 10%	C-tol. ± 5%	C-tol. ± 10%	C-tol. ± 5%			
Pitch = 7.62 ± 0.3 mm dt = 0.5 mm (+ 0.05 / - 0.05)								
0.0010	4.0 x 8.0 x 10.0	0.4	61102	62102	65102	66102		
0.0012			61122	62122	65122	66122		
0.0015			61152	62152	65152	66152		
0.0018			61182	62182	65182	66182		
0.0022			61222	62222	65222	66222		
0.0027			61272	62272	65272	66272		
0.0033			61332	62332	65332	66332		
0.0039			61392	62392	65392	66392		
0.0047			61472	62472	65472	66472		
0.0056			61562	62562	65562	66562		
0.0068			61682	62682	65682	66682		
0.0082			61822	62822	65822	66822		
0.010			5.0 x 9.5 x 10.0	0.4	61103	62103	65103	66103
0.012			5.5 x 10.0 x 10.0	0.4	61123	62123	65123	66123
0.015	6.0 x 10.5 x 10.0	0.5	61153	62153	65153	66153		

SPECIFIC REFERENCE DATA FOR THE 630V DC CAPACITORS

Description	Value		
	at 1kHz	at 10kHz	at 100kHz
Tangent of loss angle (unit : 10^{-4}) $C \leq 0.1 \square$	≤ 75	≤ 130	≤ 225
Rated voltage pulse slope(dV/dt) _R at 100V (DC)	110V/□		
R between leads at 100V, for $C \leq 0.33 \square$	□ 30 000 □		
R between interconnected leads and casing;100V ; 1min	□ 30 000 □		
Withstanding voltage DC (cut off current 10mA) ;rise time 100 V/s	1008V ; 1min		

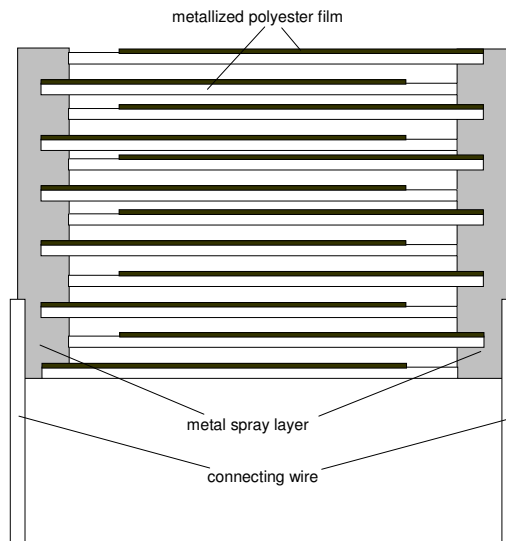
CONSTRUCTION**Description**

- . Low - inductive wound cell of metallized polyethyleneterephthalate film.
- . Protected by a hard, water repellent, solvent resistant epoxy lacquer.
- . Radial leads, tin-coated.

MOUNTING**NORMAL USE**

The capacitors are designed for mounting on printed-circuit boards. The capacitors packed in bandoliers are designed for mounting on printed-circuit boards by means of automatic insertion machines. For detailed specifications refer to Chapter " PACKAGING "

SPECIFIC METHOD OF MOUNTING TO WITHSTAND VIBRATION AND SHOCK

In order to withstand vibration and shock tests, it must be ensured that the underside of the kinks are in good contact with the printed-circuit.

The capacitors shall be mechanically fixed by the leads

STORAGE TEMPERATURE

- . Storage temperature : $T_{stg} = - 25$ to $+ 40^{\circ}\text{C}$ with RH maximum 80% without condensation.

RATINGS AND CHARACTERISTICS

specified all electrical values apply at an ambient temperature of $23 \pm 1^{\circ}\text{C}$, an atmospheric pressure of 86 to 106 kPa and a relative humidity of $50 \pm 2\%$.

For reference testing, a conditioning period shall be applied of 96 ± 4 hours by heating the products in a circulating air oven at the rated temperature and a relative humidity not exceeding 20%.

THE GRAPHS OF CHARACTERISTICS

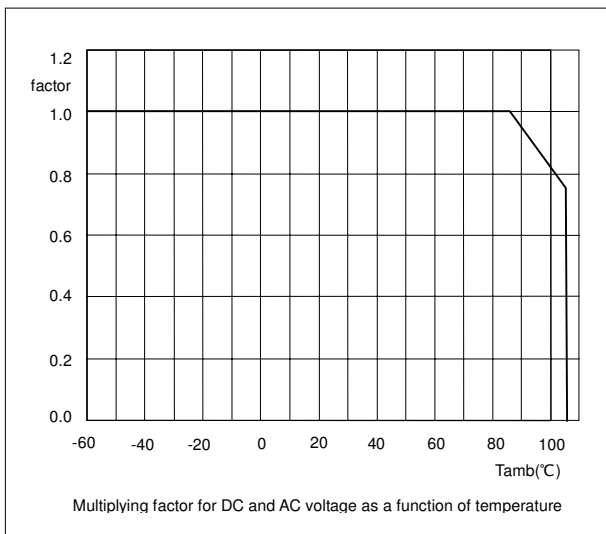
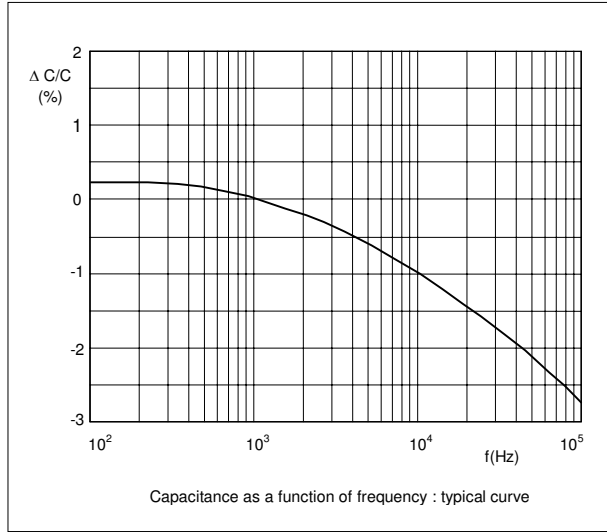
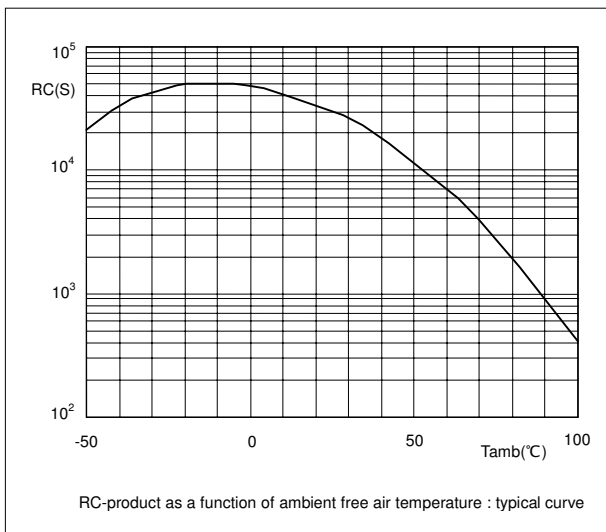
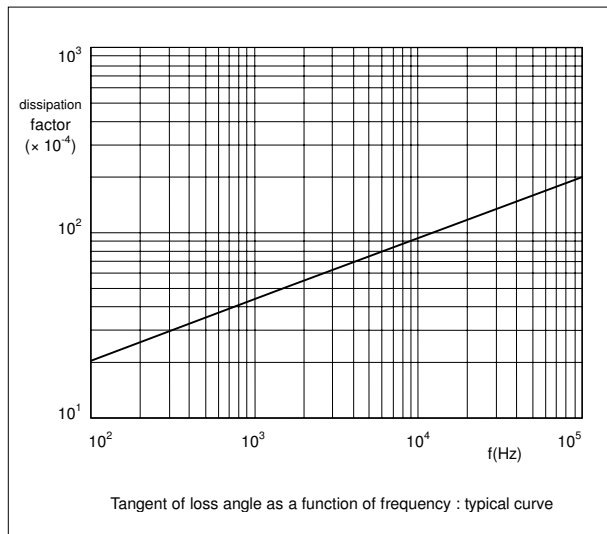
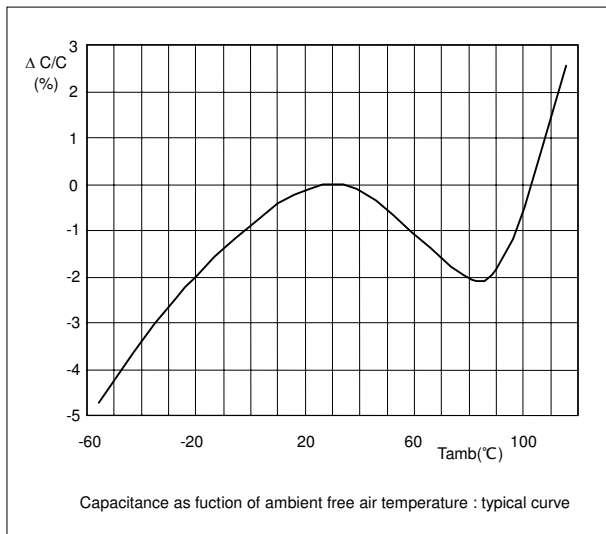

MAXIMUM RMS (63V, 100V, 250V) VOLTAGE (SINEWAVE) AS A FUNCTION OF FREQUENCY

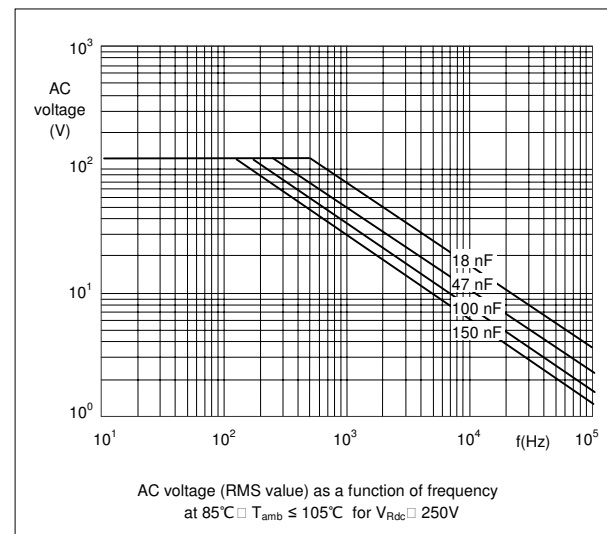
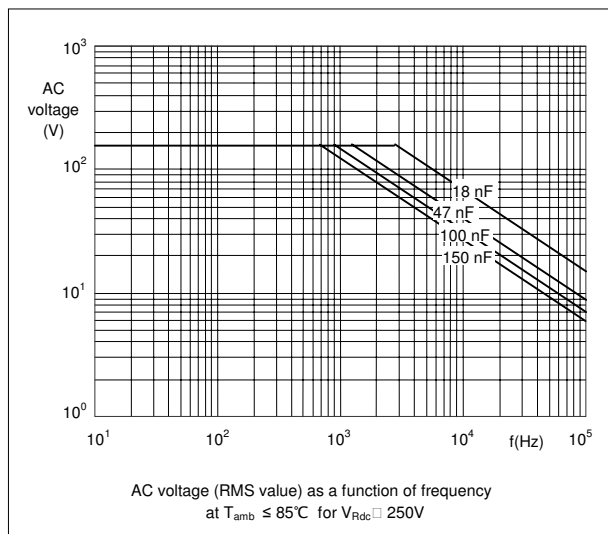
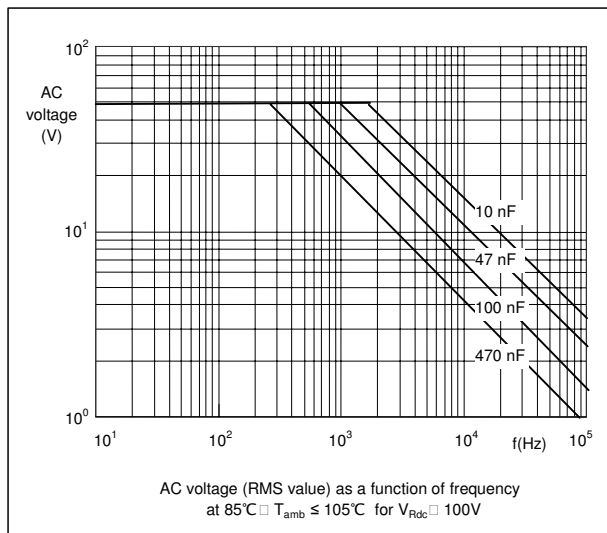
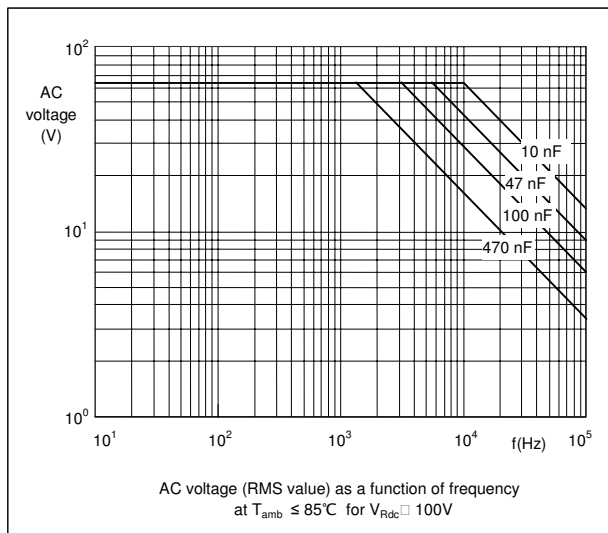
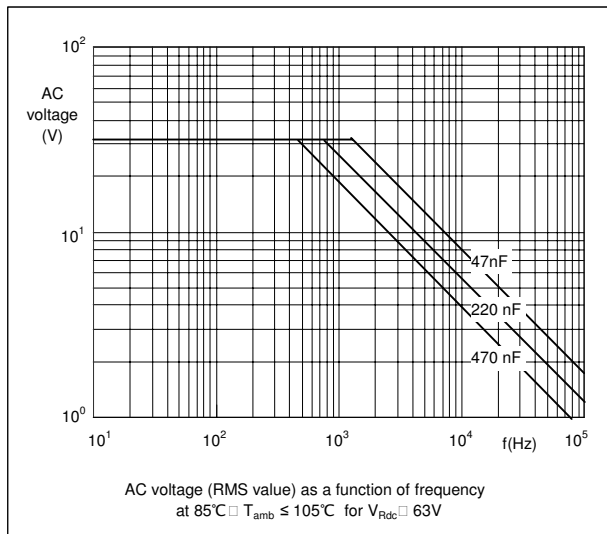
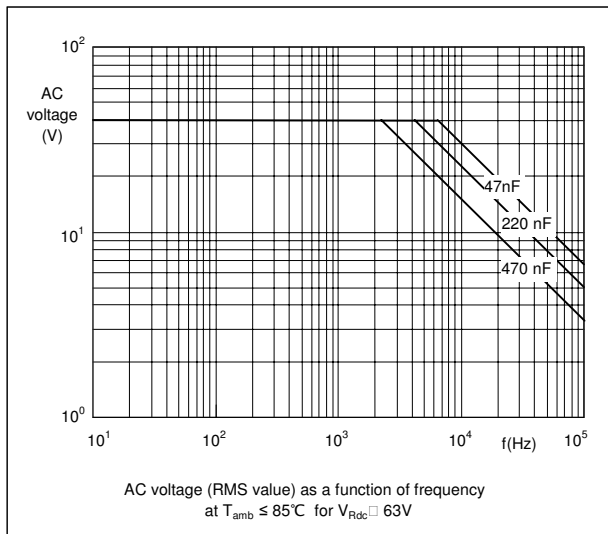

MAXIMUM RMS (400V, 630V) VOLTAGE (SINEWAVE) AS A FUNCTION OF FREQUENCY

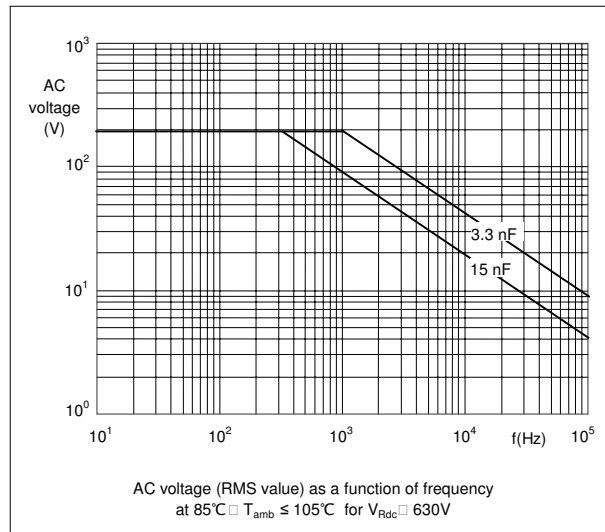
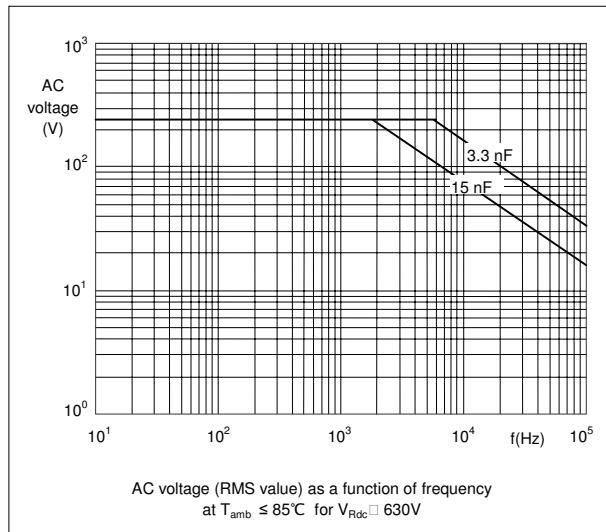
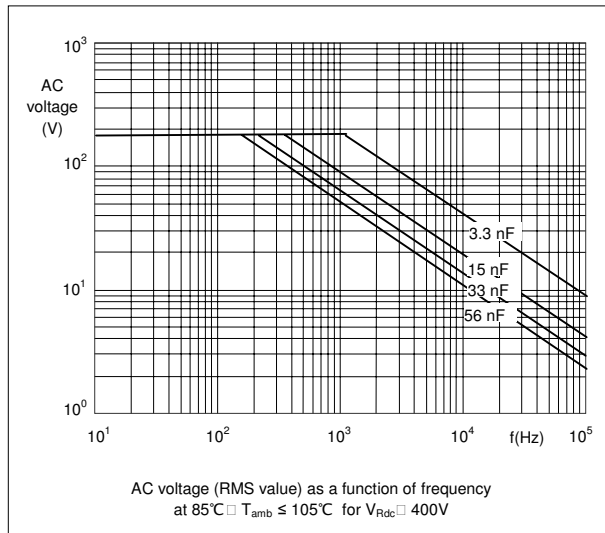
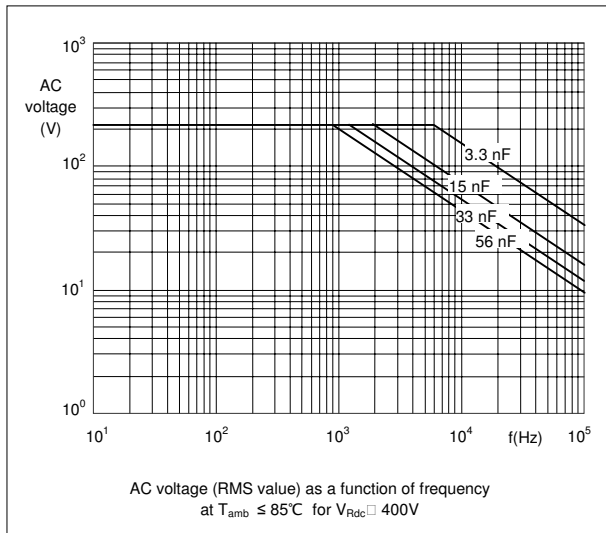

APPLICATION NOTE AND LIMITING CONDITIONS

To select this capacitor for a certain application, 6 conditions must be checked :

1. The peak voltage (V_p) shall not be greater than the rated DC voltage.
2. The peak-to-peak voltage (V_{p-p}) shall not be greater than $2\sqrt{2}$ times the rated AC voltage to avoid the ionization inception level.
3. The peak current (I_p) shall not exceed the maximum peak current, defined as maximum voltage pulse slope (dV/dt) multiplied by the capacitance.

$$I_p \text{ max.} = C (dV/dt) \text{ max}$$

Or the voltage pulse slope shall not exceed the rated voltage pulse slope. If the pulse voltage is lower than the rated voltage, the values of the table may be multiplied by V_{Rdc} and divided by the applied voltage.

4. The dissipated power shall not be greater than the maximum permissible power dissipation stated above.
5. The free air ambient temperature for the capacitor is not exceeding the category temperature.
6. Since all metallized film capacitors have an intrinsically active flammability risk, it is recommended that these capacitors should only be used in circuits where the power can be limited to less than 5W to the capacitor, should a failure occur.

PRODUCT MARKING**Capacitors with a body length \leq 7.5 mm**

The capacitors are marked on the top or side in black ink with the following information :

- . Rated capacitance code in □ or □
- . Tolerance on rated capacitance : K = $\pm 10\%$, J = $\pm 5\%$
- . Rated DC voltage

Example of marking

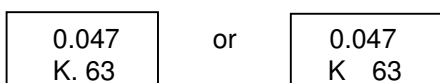
**Capacitors with a body length of 10 mm or 10.5 mm**

The capacitors are marked on the top or side in black ink with the following information :

- . Rated capacitance code in □ or □
- . Tolerance on rated capacitance : K = $\pm 10\%$, J = $\pm 5\%$
- . Rated DC voltage
- . Code for dielectric material

Example of marking

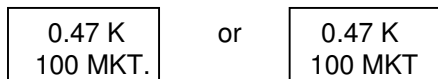
**PACKAGE MARKING**

The package containing the capacitors is marked as shown.

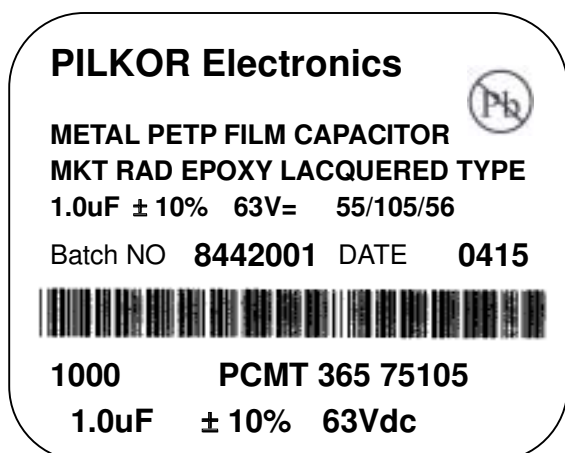
**LINE MARKING EXPLANATION**

1. Manufacturer's name
2. Sub-family
3. Pb free marking(JEDEC-STD-97)
4. Type description
5. Capacitance value, tolerance voltage and climatic category (IEC)
6. Batch nr. & production year and week code
7. Quantity & product code (12NC)
8. Capacitance, tolerance and voltage

PACKAGING
DIMENSION OF TAPED PRODUCTS

pitch = 5.0mm(kinked leads)

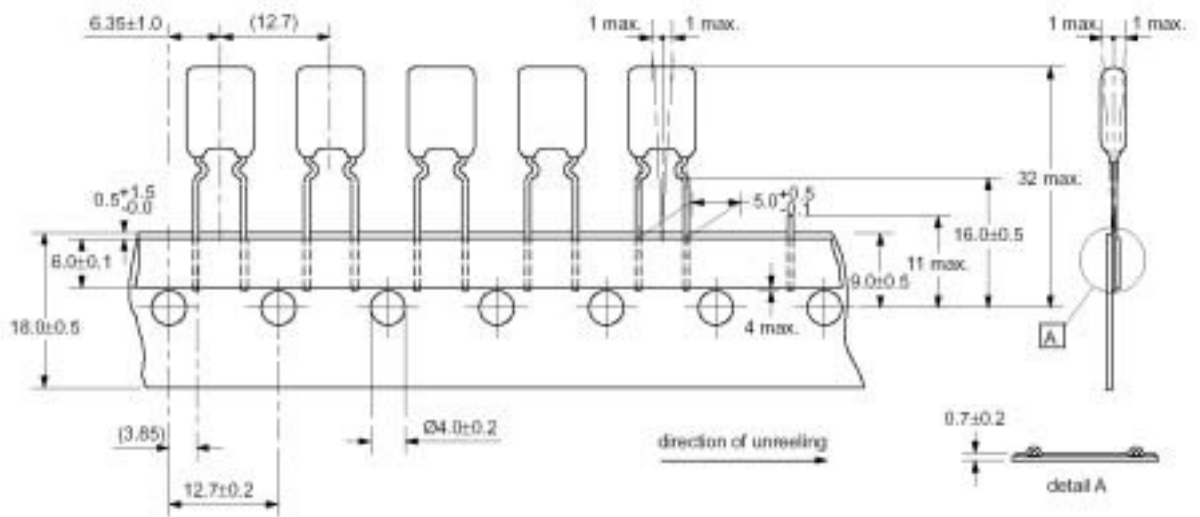
Characteristics concerning taped products

Pull – out force of the component	$\geq 5\text{N}$
Pull – out force of the adhesive tape	$\geq 6\text{N}$
Tearing force of tape	$\geq 15\text{N}$
Storage temperature	- 25 to + 40°C
Relative humidity	Max. 80% without condensation

Outlines of reel and ammo pack (dimension in mm)

pitch = 5.0mm

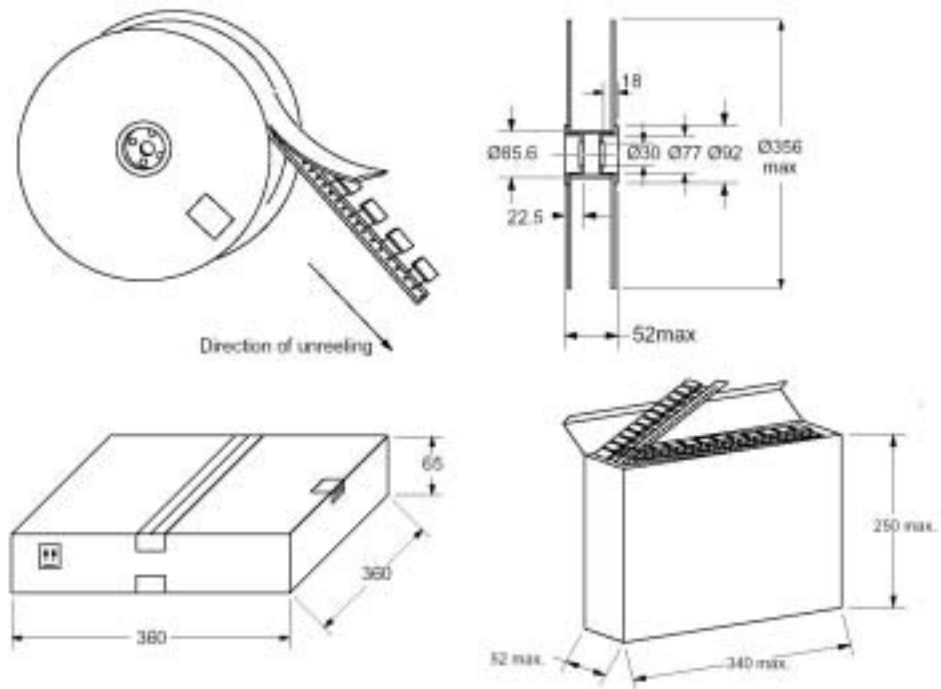

Cumulative pitch error : 1.0mm/20 pitches

The max. number of empty places per reel shall not exceed 0.5% of total number of components per reel, but no more than 2 consecutive positions may be vacant.

INSPECTION REQUIREMENTS

Note 1 : Sub-clause numbers of tests and performance requirements refer to the Sectional Specification, IEC 60384-2 and Section One this specification.

Note 2 : Inspection levels are selected from IEC-Publication 410: Sampling Plans and Procedures for inspection by attributes.

Note 3 : In this table : p = periodicity in months
n = sample size
D = destructive
ND = non-destructive
IL = inspection level) IEC 410
AQL = acceptance quality level)

Note 4 : For this capacitors, considered as a solid construction, the periodicity of the vibration and shock test is reduced from 6 months to 36 months.

Clause number and Test	D or ND	Condition	IL	n	Performance Requirements
Group A inspection (lot by lot)					
Sub-Group A1	ND				
4.1 Visual examination		Detail	S4	1)	No visual damage , legible marking and as specified in Marking specification
Dimensions 2)			S3	1)	As specified in dimension table of this specification
Sub-Group A2 3)	ND				
4.2.2 Capacitance 4.2.3 Tangent of loss angle 4.2.1 Voltage proof		At 1kHz At 100kHz for C≤ 470nF At 10kHz for C> 470nF 63Vdc 100V, 1min 100Vdc 160V, 1min 250Vdc 400V, 1min 400Vdc 640V, 1min 630Vdc 1010V, 1min			Within specified tolerance As in rating and characteristics of this specification No permanent breakdown (cut-off current 10mA) or flash over Self-healing allowed Rise time : 100V/sec
4.2.4 Insulation resistance (test A)		63Vdc 10Vdc 100, 250, 400Vdc 100Vdc 630Vdc 500Vdc			As in rating and characteristics of this specification

1) Number to be tested : Sample size as directly allotted to the code letter for IL in Table 2A of IEC 410 (Single sampling plan for normal inspection)
The acceptance number complies with AQL value : 0.65 %

2) This test may be replaced by in-production testing, if SPC on dimensional measurements or other mechanisms to avoid parts exceeding the limits is installed.

3) The 100% End-of-line testing is followed by re-inspection by sampling in order to monitor outgoing quality level by defectives per million (DPM). The sampling level and the calculation of DPM values is in accordance with CECC 00 014, counting any parametric failure as a defective. In case one or more defectives occur in a lot, this lot shall be rejected.

Clause number and Test	D or ND	Condition	p	n	Performance Requirements
Group C inspection (periodic)			6	9	
Sub-group C1A Part of a sample of sub-group C1	D				
4.1 dimension (detail)					As specified in dimension table of this specification
4.3.1 initial measurement		1. Capacitance at 1kHz 2. Tangent of loss angle At 100kHz for $C \leq 470\text{nF}$ At 10kHz for $C > 470\text{nF}$			
4.3 robustness of terminations		Tensile and bending			No visible damage
4.4 resistance to soldering heat		Method : 1A Solder bath : 260°C Duration : 10 s			
4.14 component solvent resistance		Isopropylalcohol at room temperature Method : 2 Immersion time : $5 \pm 0.5\text{min}$ Recovery time : min 1 hour max 2 hour			
4.4.2 final measurements		Visual examination			No visible damage Legible marking
		1. Capacitance at 1kHz 2. Tangent of loss angle At 100kHz for $C \leq 470\text{nF}$ At 10kHz for $C > 470\text{nF}$			$\Delta C/C \leq 2\%$ of the value measured initially Increase of tanD 1) $C \leq 100\text{nF}$ ≤ 0.005 2) $100\text{nF} < C \leq 220\text{nF}$ ≤ 0.010 3) $220\text{nF} < C \leq 470\text{nF}$ ≤ 0.015 4) $C > 470\text{nF}$ ≤ 0.003

Clause number and Test	D or ND	Condition	p	n	Performance Requirements
Group C inspection (periodic)					
Sub-group C1B Other part of a sample of sub-group C1	D		6	18	
4.6.1 initial measurement 4.6 rapid change of temperature 4.7 vibration (see note 4) 4.7.2 final examination 4.9 shock (see note 4) 4.9.3 final measurements		<p>1. Capacitance at 1kHz 2. Tangent of loss angle At 100kHz for $C \leq 470\text{nF}$ At 10kHz for $C > 470\text{nF}$ ΘA = lower category temperature ΘB = upper category temperature 5 cycles duration time : 30 min</p> <p>Method of mounting : see the mounting of this specification Procedure : B4 Frequency range 10Hz to 55Hz amplitude : 0.75mm or acceleration 98m/s^2 (which is less severe) Total duration : 6 hours</p> <p>Visual examination</p> <p>Method of mounting : see the mounting of this specification Pulse shape : half sine Acceleration : 490 m/s^2 Duration of pulse : 11ms Visual examination</p> <p>1. Capacitance at 1kHz 2. Tangent of loss angle At 100kHz for $C \leq 470\text{nF}$ At 10kHz for $C > 470\text{nF}$</p> <p>Insulation resistance</p>			<p>No visible damage</p> <p>No visible damage</p> <p>$\Delta C/C \leq 3\%$ of the value measured initially Increase of tanD 1) $C \leq 100\text{nF}$ ≤ 0.005 2) $100\text{nF} < C \leq 220\text{nF}$ ≤ 0.010 3) $220\text{nF} < C \leq 470\text{nF}$ ≤ 0.015 4) $C \square 470\text{nF}$ ≤ 0.003 As in rating and characteristics of this specification</p>

Clause number and Test	D or ND	Condition	p	n	Performance Requirements
Group C inspection (periodic)					
Sub-group C1 Combined sample of specimens of sub-groups C1A and C1B	D		6	18	
4.11 climatic sequence 4.11.2 dry heat 4.11.3 damp heat cyclic test Db, first cycle 4.11.4 cold 4.11.6 damp heat cyclic test Db, remaining cycle 4.11.6.2 final measurements		<p>$T = T_{\text{upper-category temperature}}$ Duration : 16 hours</p> <p>$T = T_{\text{lower-category temperature}}$ Duration : 2 hours</p> <p>Visual examination</p> <p>1. Capacitance at 1kHz</p> <p>2. Tangent of loss angle At 100kHz for $C \leq 470\text{nF}$ At 10kHz for $C > 470\text{nF}$</p> <p>Insulation resistance</p>			<p>No visible damage Legible marking</p> <p>$\Delta C/C \leq 5\%$ of the value measured initially</p> <p>Increase of tanD 1) $C \leq 100\text{nF}$ ≤ 0.007 2) $100\text{nF} < C \leq 220\text{nF}$ ≤ 0.010 3) $220\text{nF} < C \leq 470\text{nF}$ ≤ 0.015 4) $C > 470\text{nF}$ ≤ 0.005</p> <p>$\geq 50\%$ of values in ratings and characteristics of this specification</p>

Clause number and Test	D or ND	Condition	p	n	Performance Requirements
Sub-group C2	D		6	15	
4.12 damp heat steady state 4.12.1 initial measurements 4.12.3 final measurements		56 days, 40°C 90 – 95% R.H 1. Capacitance at 1kHz 2. Tangent of loss angle at 1kHz Visual examination 1. Capacitance at 1kHz 2. Tangent of loss angle At 100kHz for C ≤ 470nF At 10kHz for C > 470nF Insulation resistance			No visible damage Legible marking $\Delta C/C \leq 5\%$ of the value measured initially Increase of tanD 1) C ≤ 100nF ≤ 0.007 2) 100nF < C ≤ 220nF ≤ 0.010 3) 220nF < C ≤ 470nF ≤ 0.015 4) C > 470nF ≤ 0.005 $\geq 50\%$ of values in ratings and characteristics of this specification

Clause number and Test	D or ND	Condition	p	n	Performance Requirements
Sub-group C3	D		3	21	
4.12 Endurance test		Duration : 2000 hours 85°C : 1.25 x U _R 105°C : 1.25 x U _C (U _C : 0.75 x U _R)			
4.12.1 initial measurements		1. Capacitance at 1kHz 2. Tangent of loss angle At 100kHz for C ≤ 470nF At 10kHz for C > 470nF			
4.12.3 final measurements		Visual examination 1. Capacitance at 1kHz 2. Tangent of loss angle At 100kHz for C ≤ 470nF At 10kHz for C > 470nF Insulation resistance			No visible damage Legible marking ΔC/C ≤ 5% of the value measured initially Increase of tanD 1) C ≤ 100nF ≤ 0.005 2) 100nF < C ≤ 220nF ≤ 0.010 3) 220nF < C ≤ 470nF ≤ 0.015 4) C □ 470nF ≤ 0.003 ≥ 50% of values in ratings and characteristics of this specification

Clause number and Test	D or ND	Condition	p	n	Performance Requirements
Sub-group C4	D		3	9	
4.15.1 initial measurements		1. Capacitance at 1kHz 2. Tangent of loss angle At 100kHz for C ≤ 470nF At 10kHz for C > 470nF			
4.15 charge and discharge		10000 cycles : charge to U _R half sine wave Duration : 5ms Discharge resistance $R = \frac{U_R}{2.5 \times C \times (dU/dt)_R}$ with a minimum : 2.2Ω			
4.15.3 final measurements		1. Capacitance at 1kHz 2. Tangent of loss angle At 100kHz for C ≤ 470nF At 10kHz for C > 470nF Insulation resistance			$\Delta C/C \leq 3\%$ of the value measured initially Increase of tanD 1) C ≤ 100nF ≤ 0.005 2) 100nF < C ≤ 220nF ≤ 0.010 3) 220nF < C ≤ 470nF ≤ 0.015 4) C > 470nF ≤ 0.003 ≥ 50% of values in ratings and characteristics of this specification

Clause number and Test	D or ND	Condition	p	n	Performance Requirements
Sub-group ADD1	D		3	10	
A.1 Solder ability Solvent resistance of the marking		Without aging Method : 1 Non-activated colophiny flux 501 Solder bath : 235°C Dwell time : 2 s Isopropylalcohol at room temperature. Method : 1 Rubbing material cotton wool Immersion time : 5± 0.5min			Good tinning as evidenced by free flowing of the solder with wetting of the termination(□ 95%) Legible marking
Sub-group ADD2	D		3	12	
A.2 Heat storage A.2.1 Initial measurement A.2.2 Final measurement		Duration : 2000h Temperature : upper category temperature 1. Capacitance at 1kHz 2. Tangent of loss angle At 100kHz for C≤ 470nF At 10kHz for C> 470nF 1. Capacitance at 1kHz 2. Tangent of loss angle At 100kHz for C≤ 470nF At 10kHz for C> 470nF Insulation resistance			$\Delta C/C \leq 3\%$ of the value measured initially Increase of tanD 1) C ≤ 100nF ≤ 0.005 2) 100nF < C ≤ 220nF ≤ 0.010 3) 220nF < C ≤ 470nF ≤ 0.015 4) C □ 470nF ≤ 0.003 As in Rating and CHARACTERISTICS of this specification

Clause number and Test	D or ND	Condition	p	n	Performance Requirements
Sub-group ADD3	D		3	9	
A.3 Endurance for capacitor max. a.c. volt \geq 200V(r.m.s)		Duration : 1000hours Temp : 85°C Voltage for 400V : 1.25 x max. a.c. voltage(r.m.s value), 50~ 60Hz Voltage for 630V : 1.1 x max. a.c. voltage(r.m.s value), 50~ 60Hz			
A.3.1 Initial measurement		1. Capacitance at 1kHz 2. Tangent of loss angle At 100kHz for $C \leq 470\text{nF}$ At 10kHz for $C > 470\text{nF}$			
A.3.2 Final measurement		1. Capacitance at 1kHz 2. Tangent of loss angle At 100kHz for $C \leq 470\text{nF}$ At 10kHz for $C > 470\text{nF}$			$\Delta C/C \leq 5\%$ of the value measured initially Increase of tanD 1) $C \leq 100\text{nF}$ ≤ 0.005 2) $100\text{nF} < C \leq 220\text{nF}$ ≤ 0.010 3) $220\text{nF} < C \leq 470\text{nF}$ ≤ 0.015 4) $C \square 470\text{nF}$ ≤ 0.003 As in Rating and CHARACTERISTICS of this specification
		Insulation resistance			

Clause number and Test	D or ND	Condition	p	n	Performance Requirements
Sub-group ADD4	D		3	9	
A.4 Detergent resistance		Density 20g/L dishwasher detergent Temperature 70°C during 3 minutes followed by rinsing in clear water for 1 minute Recovery time : 1 to 2 hours			
A.4.1 Initial measurement		1. Capacitance at 1kHz 2. Tangent of loss angle At 100kHz for C ≤ 470nF At 10kHz for C > 470nF			
A.4.2 Final measurement		1. Capacitance at 1kHz 2. Tangent of loss angle At 100kHz for C ≤ 470nF At 10kHz for C > 470nF			$\Delta C/C \leq 1\%$ of the value measured initially Increase of tanD 1) C ≤ 100nF ≤ 0.005 2) 100nF < C ≤ 220nF ≤ 0.010 3) 220nF < C ≤ 470nF ≤ 0.015 4) C □ 470nF ≤ 0.003 ≥ 50% of values in ratings and characteristics of this specification
Sub-group ADD5	D		6	15	
A.5 Resistance to soldering heat with preheating		Capacitors mounted on 1.6mm board with nonplated hole Body temp : 80°C Bath temp : □ 260°C Dwell time : 10 s			
A.5.1 Initial measurement		1. Capacitance at 1kHz 2. Tangent of loss angle At 100kHz for C ≤ 470nF At 10kHz for C > 470nF			
A.5.2 Final measurement		1. Capacitance at 1kHz 2. Tangent of loss angle At 100kHz for C ≤ 470nF At 10kHz for C > 470nF			$\Delta C/C \leq 2\%$ for ≤ 10nF $\Delta C/C \leq 1\%$ for □ 10nF of the value measured initially Increase of tanD 1) C ≤ 100nF ≤ 0.005 2) 100nF < C ≤ 220nF ≤ 0.010 3) 220nF < C ≤ 470nF ≤ 0.015 4) C □ 470nF ≤ 0.003
Sub-group ADD6	D		3	15	
A.6 climatic test on taped type		10 days at 40 ± 2°C R.H. 90 to 95% Recovery time : 24 hours			Angle of component ≤ 4° Pull out and tearing forces ≥ of 50% of the value in General Data of this specification.



MATERIAL LIST

- Product type ; Metallized polyester film capacitors

- Model name ; PCMT 365/ 366/ 367 XXXXX

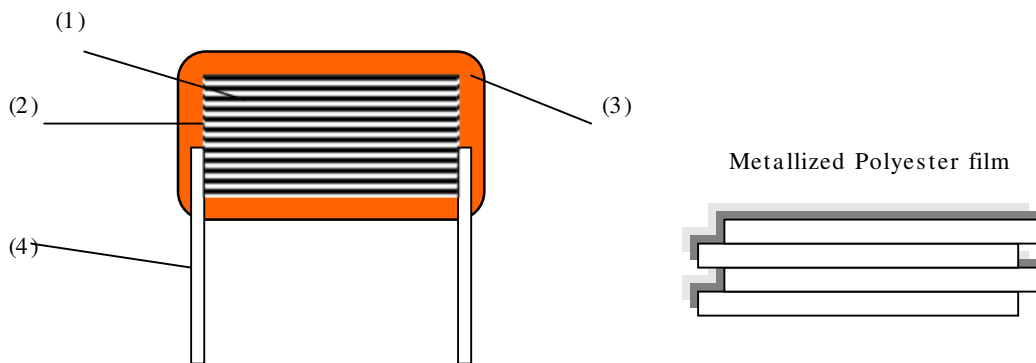

	Description	Material	Supplier
1	M-PET Film	Metallized polyester	SUNGMOON Elec.(Korea) STEINER GMBH(Germany) NUINTEK(Korea)
2	Metal Spray	Tin-Zinc	SAMHWA Non-Ferrous metal Ind. SHINSAENG metal Ind.
3	Epoxy Powder	UL94V-0	DAEJOO Fine chemical GREEN STAR
4	Lead Wire	Fe + Cu 0.5mm [Sn100%:10 □]	ILKWANG DAE-A LEAD

** Solderability : 235°C, 2 sec

** Resistance to soldering heat : 260°C, 10 sec

