

ED SERIES SAFETY LIMIT SWITCH - HIGHLY

HIGHLY

The ED series safety limit switches conform to EN 50047 and have been developed to provide a range of options including plastic cases in various sizes, a choice of snap acting, slow break/make with 2 contact configurations and a choice of actuator heads. The ED series offers the option of rotating the head in 90° increments before installation to allow ease of mounting. Highly limit switches can be used in other applications other than guard doors, for example on moving machine beds, crane arms, lifts, elevators, etc. Operation of these limit switches is achieved by the sliding action of the guard or other moving object deflecting the plunger or lever. For safety applications it is important that upon actuation, the guard or other moving objects should not pass completely over the switch and allow the plunger or lever to return to its original position.

Features:

- Conforms to EN (TUV) standards corresponding to the CE marking
- Positive opening operation of NC (Normally Closed) contacts conforming to IEC /EN 60947-5-1
- Double insulation makes ground terminal unnecessary (Bears marking)
- Wide standard operating temperature range: -25°C to 80°C
- Full range of actuator heads and levers suitable for safety applications
- Sealing up to IP 67
- Wide switch variations, (Snap action and slow action basic switches)
- International conduit sizes

SPECIFICATIONS:

Standards	EN60947-5-1, UL508, EN50047, EN1088
Approvals	cULus, TUV and CE marked for all applicable directives
Positive Opening Operation	NC Contact
Utilization Category	AC15 A600
Min Current	5V, 5mA, DC
Thermal Current (Ith)	10A
Rated Insulation Voltage	600V AC
Rated Impulse withstand Volt	2500V AC
Insulation Resistance	100MΩ min. (DC 500V)
Contact Resistance	25mΩ max. (Initial)
Max Switching Speed	250mm/s
Max Switching Frequency	6000 operation per hour
Enclosure Material	UL approved glass-filled polybutylene terephthalate
Roller Material	Various polymers
Enclosure Protection	IP 67
Operating Temperature	Min -25°C (-18°F) Max 80°C (+176°F)
Pollution Degree	3
Protection Against Electric Shock	Class II (Double Insulation)
Mech. Life Expectancy	1 x 10 ⁷ Cycle min
Electrically Life Expectancy	150,000 Cycle min
Vibration	IEC 68-2-6, 10-55Hz±1 Hz, Excursion: 0.35mm, 1 octave/min
Conduit Entry	Various (see Product Selection table)
Fixing	2 x M4

Structure Description

Metal Lever Setting

Grooves which engage the lever every 18° are cut in the operation indicator disk to prevent the lever from slipping against the rotary shaft.

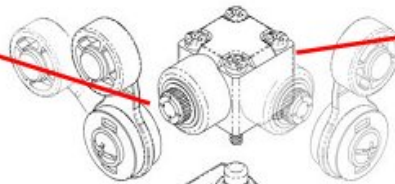

Hand

With roller lever models, the direction of the switch head can be varied to any of the four directions by loosening the roller lever switch screws at the four corners of the head.

Cover

The cover, with a hinge on its lower part, can be opened by removing the screw of the cover, which ensures ease of maintenance and wiring.

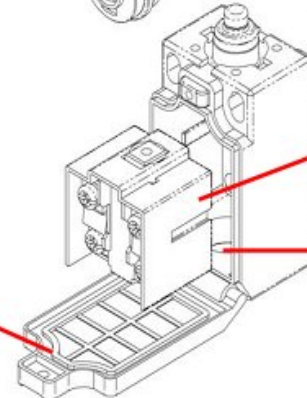

Contact Block

Wide switch variations.
Snap-action: 1NC/1NO
Slow-action: 1NC/1NO, 2NC

Conduit

Wide switch variations.
PG13.5 PG11
M16 M20
1/2-14NPT

Product Selection

ED-□-□-□
1 2 3

1. THREAD DIMENSION OF LEAD EXIT

- 1: PG13.5 (S)
- 2: 1/2NPT (C)
- 4: PG11 (O)
- 5: M16 (C)
- 6: M20 (O)
- 7: Connector (C)

2. CONTACT TYPES

- 1: 1NC/1NO SLOW ACTION (BBM) (S)
- 2: 2NC SLOW ACTION (O)
- 3: 1NC/1NO SNAP ACTION (C)

3. HEAD AND ACTUATOR

- 20: Roller arm type
- 21: Adjustable roller arm type (standard roller)
- 22: Adjustable roller arm type (Long arm type)
- 24: Thermoplastic end flexible rod type
- 241: Cat whisker type
- 242: Wobble stick type
- 25: Rod lever type
- 27: Adjustable roller arm type (big roller)
- 31: Push plunger type
- 32: Roller plunger type
- 62: Roller lever type
- 63: One-Way roller arm lever type

*(s):standard (o):option (c): customization

M12 Connector
pin arrangement

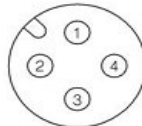

Contact Block Form

TYPE	CONTACT FORM	CONNECTOR PIN ARRANGEMENT	OPERATION DIAGRAMS	
			Closed	Open
ED-□-1-□□	1NC/1NO(Slow action) (See Note 1)			
ED-□-2-□□	2NC (Slow action) (See Note 2)			
ED-□-3-□□	1NC/1NO(Snap action) (See Note 1)			

Note: 1. Only NC contact 11-12 has an approved positive opening mechanism.

2. NC contacts 11-12 and 21-22 have an approved positive opening mechanism.

Positive Opening Mechanism

1NC/1NO Contact (Snap action)

Conforms to EN60947-5-1 Positive Opening

If metal deposition between mating contacts occurs on the NC contact side, they can be pulled apart by the shearing force and tensile force generated when the safety cam or plunger engages the movable contact blade. When the safety cam or plunger is moved in the direction of the black arrow the Limit Switch releases.

1. When metal deposition occurs.
2. When contacts are being pulled apart.
3. When contacts are completely pulled apart.

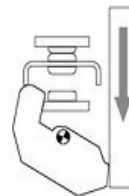
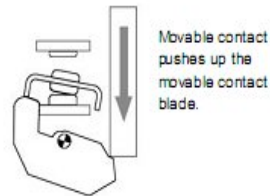
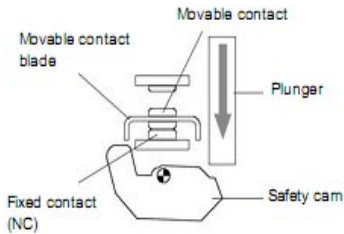

ED-27
Adjustable Roller
Arm Type (Big roller)



Slow Action 1NC\1NO
ED-__-1-27

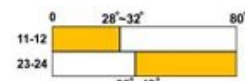

Slow Action 2NC
ED-__-2-27

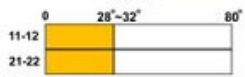

Snap Action 1NC\1NO
ED-__-3-27

