

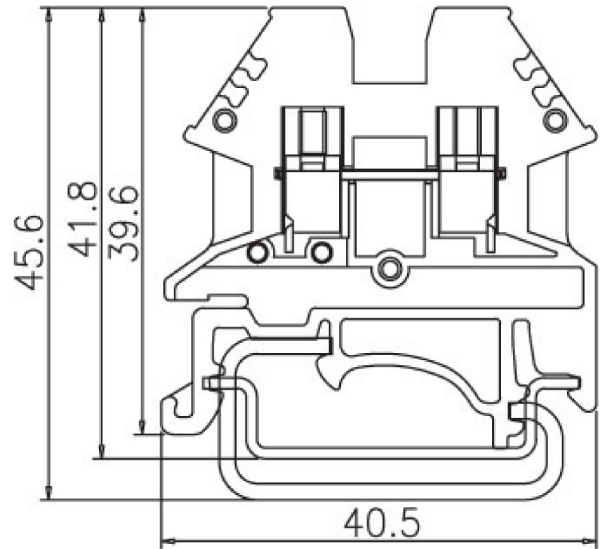

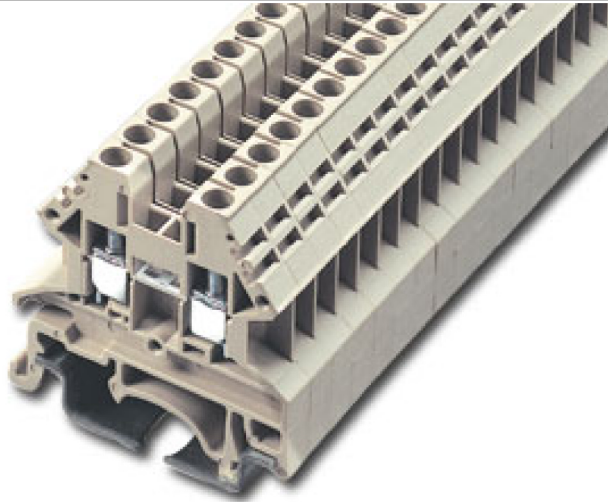



DIN Rail terminal blocks / DK..N series



DK2.5N



Approval	 	
Technical Data	UL	IEC
Rated voltage	600V	1000V
Rated current	20A	24A
Conductor cross-section, solid (AWG / mm ²)	22~12 / 0.34~2.5	
Conductor cross-section, flexible (AWG / mm ²)	22~12 / 0.34~2.5	
Rated impulse withstand voltage	6KV	
Torque (N-m)	0.4	0.4
Screw	M2.5	
Wire strip length	9~11mm	
Insulating material	PA	
TxHxW (mm)	5.1 x 39.6 x 40.5	
Optional color	Cat. No.	
	DK2.5N-RD	
	DK2.5N-BL	
	DK2.5N-BK	
	DK2.5N-OR	



	Accessories	Cat. No.
End cover		DK4NC
Partition		
Small partition		DKNSPS-001
Insertion bridge	2 way	DSS2.5N-02P
	:	:
	:	:
Insertion bridge	10 way	DSS2.5N-10P
	:	:
	:	:
Insertion bridge	2 way	CSC-2.502PN
	:	:
	:	:
Insertion bridge	10 way	CSC-2.510PN
	:	:
	:	:
Screw-on bridge		
Marking label		TM26
Mounting Rail		TS-35 / TS-32
Tool		