

25.431. *



Material

Insulator:PA
Body:Brass
Surface:Nickel plated
*Solder connection

Rated voltage/current
30Vac-60Vdc/Max.24A

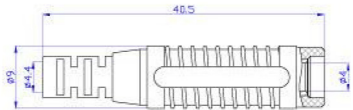

25.502. *



Material

Insulator:PA
Body:Brass
Spring:Beryllium copper
Surface:Nickel plated
*Solder connection

Rated voltage/current
CATII 1000V/Max.32A

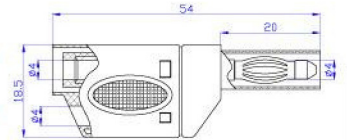

25.450. *



Material

Insulator:PA
Body:Brass
Spring:Beryllium copper
Surface:Nickel plated
*Solder connection

Rated voltage/current
CATII 600V/Max.32A

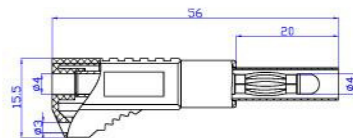

25.503. *



Material

Insulator:PA
Body:Brass
Spring:Beryllium copper
Surface:Nickel plated
*Solder connection

Rated voltage/current
CATII 1000V/Max.32A

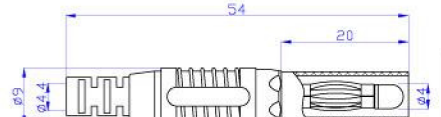

25.451. *



Material

Insulator:PA
Body:Brass
Spring:Beryllium copper
Surface:Nickel plated
*Press connection

Rated voltage/current
30Vac-60Vdc/Max.32A

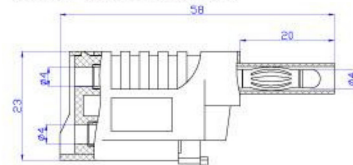

25.504. *



Material

Insulator:PA
Body:Brass
Spring:Beryllium copper
Surface:Nickel plated
*Solder connection

Rated voltage/current
CATII 1000V/Max.32A

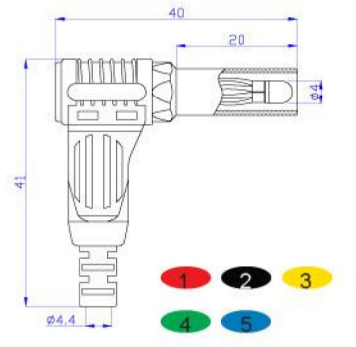
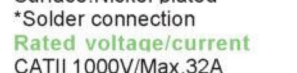

25.501. *



Material

Insulator:PA
Body:Brass
Spring:Beryllium copper
Surface:Nickel plated
*Solder connection

Rated voltage/current
CATII 600V/Max.32A

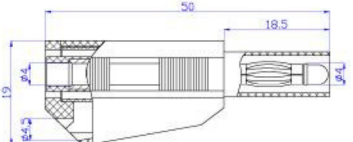

25.505. *



Material

Insulator:PA
Body:Brass
Surface:Nickel plated
*Solder connection

Rated voltage/current
CATII 600V/Max.19A

