

MINIATURE TOGGLE SWITCH

小型雙投開關

SPECIFICATIONS

CONTACT RATING—5 amps with resistive load @ 120VAC or 28VDC;
2 amps with resistive load @ 250VAC.

ELECTRICAL LIFE—50,000 make-and-break cycles at full load
CONTACT RESISTANCE—10 milliohms max. initial @ 2-4VDC,
100 milliamps for both coin silver and gold plated contacts.

INSULATION RESISTANCE—100 megohms min.

DIELECTRIC STRENGTH—1,000 volts RMS @ sea level.

OPERATING TEMPERATURE— -20°C to 65°C

Series T80  5A 125VAC or 28VDC, 2A 250VAC

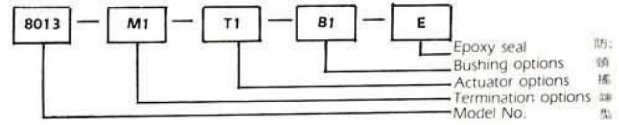

Order guide: 型號說明



- ① If customer do not indicate the complete option, we'll supply standard (STD) type.
- ② Available options for T80 series are shown on page 10.
- ③ 如果客戶未指明，將以提供“標準品”為準。
- ④ 請參閱第10頁圖樣說明。

SPDT



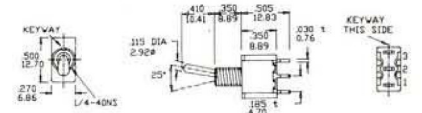

Model No.	Switching Position		
			
8013	ON	NONE	ON
8013A	ON	NONE	(ON)
8014	ON	OFF	ON
8014A	(ON)	OFF	(ON)
8014B	ON	OFF	(ON)
Term CONN	2-3	OPEN	2-1

Schematic 



DPDT



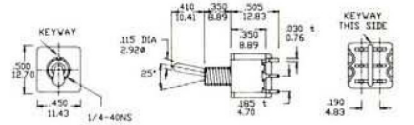

Model No.	Switching Position		
			
8011	ON	NONE	ON
8011A	ON	NONE	(ON)
8012	ON	OFF	ON
8012A	(ON)	OFF	(ON)
8012B	ON	OFF	(ON)
Term CONN	2-3, 5-6	OPEN	2-1, 5-4

Schematic 



3PDT



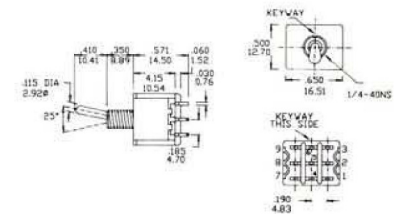

Model No.	Switching Position		
			
T8301	ON	NONE	ON
T8303	ON	NONE	(ON)
T8305	ON	OFF	ON
T8307	(ON)	OFF	(ON)
T8309	ON	OFF	(ON)
Term CONN	2-3, 5-6, 8-9	OPEN	2-1, 5-4, 8-7

Schematic 



4PDT



Model No.	Switching Position		
			
T8401	ON	NONE	ON
T8403	ON	NONE	(ON)
T8405	ON	OFF	ON
T8407	(ON)	OFF	(ON)
T8409	ON	OFF	(ON)
Term CONN	2-3, 5-6, 8-9, 11-12	OPEN	2-1, 5-4, 8-7, 11-10

Schematic 

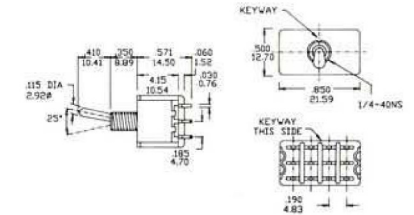

MINIATURE TOGGLE SWITCH

小型雙投開關

SPECIFICATIONS

CONTACT RATING—0.4 Volt-Amps (VA) max.
@ 20V max. (AC or DC)

ELECTRICAL LIFE—50,000 make-and-break cycles at full load
CONTACT RESISTANCE—10 milliohms max. initial @ 2-4VDC,
100 milliamps for both coin silver and gold plated contacts.

INSULATION RESISTANCE—100 megohms min.

DIELECTRIC STRENGTH—1,000 volts RMS @ sea level.

OPERATING TEMPERATURE—-20°C to 65°C

Order guid: 型號說明

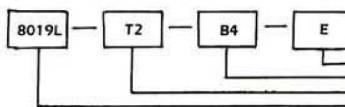

Epoxy seal
Bushing options
Actuator options
Model No.

防水膠
鎖管套
搖柄
型號

- ① If customer do not indicate the complete option, we'll supply standard [STD] type.
- ② Available options for PT80 series are shown on page 10.
- ③ 如果客戶未指明，將以提供“標準品”為準。
- ④ 請參閱第10頁圖樣說明。

Series PT80 P.C. Mounted



5A 125VAC or 28VDC, 2A 250VAC

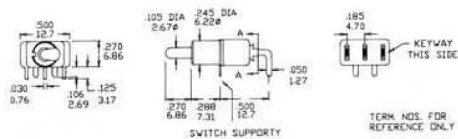

Model No.	Switching Position		
8019	ON	NONE	ON
8019A	ON	NONE	(ON)
8020	ON	OFF	ON
8020A	(ON)	OFF	(ON)
8020B	ON	OFF	(ON)
Term CONN	2-3	OPEN	2-1

Schematic

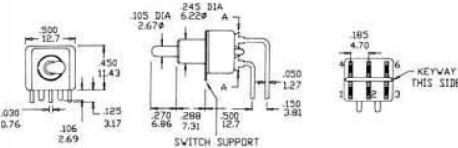
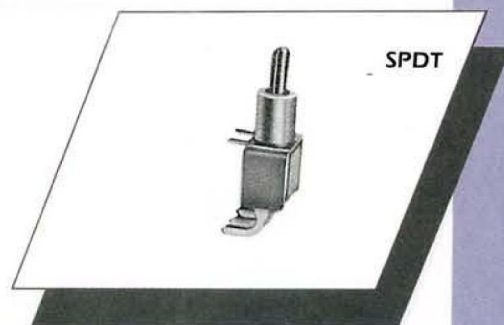
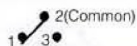

Model No.	Switching Position		
8021	ON	NONE	ON
8021A	ON	NONE	(ON)
8022	ON	OFF	ON
8022A	(ON)	OFF	(ON)
8022B	ON	OFF	(ON)
Term CONN	2-3, 5-6	OPEN	2-1, 5-4

Schematic

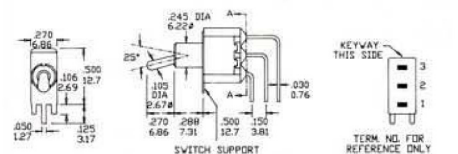
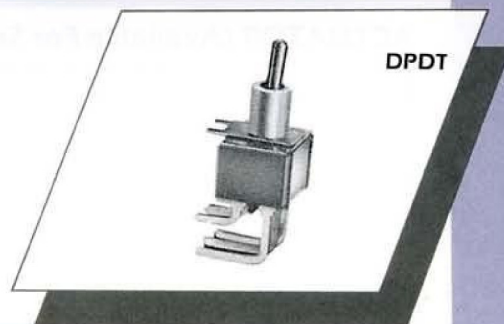

Model No.	Switching Position		
8019L	ON	NONE	ON
8019LA	ON	NONE	(ON)
8020L	ON	OFF	ON
8020LA	(ON)	OFF	(ON)
8020LB	ON	OFF	(ON)
Term CONN	2-3	OPEN	2-1

Schematic

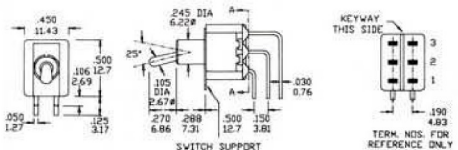
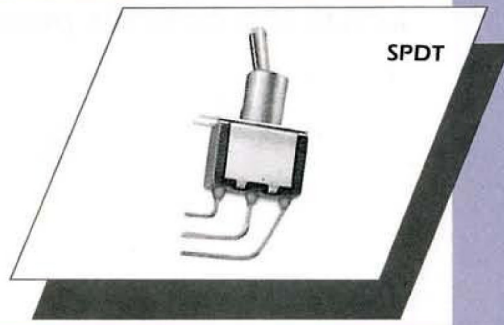

Model No.	Switching Position		
8021L	ON	NONE	ON
8021LA	ON	NONE	(ON)
8022L	ON	OFF	ON
8022LA	(ON)	OFF	(ON)
8022B	ON	OFF	(ON)
Term CONN	2-3, 5-6	OPEN	2-1, 5-4

Schematic

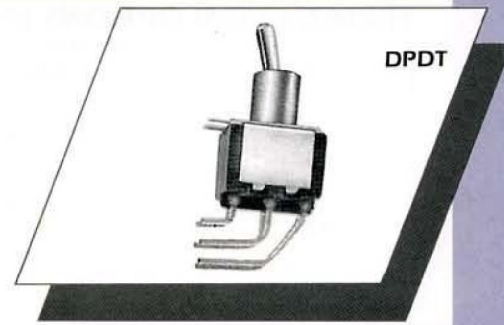

MINIATURE TOGGLE SWITCH

小型雙投開關

Series PT80 P.C. Mounted



Model No.	Switching Position		
	ON	NONE	ON
PT8301	ON	NONE	ON
PT8303	ON	NONE	(ON)
PT8305	ON	OFF	ON
PT8307	(ON)	OFF	(ON)
PT8309	ON	OFF	(ON)
Term CONN	2-3, 5-6 8-9	OPEN	2-1, 5-4 8-7

Schematic

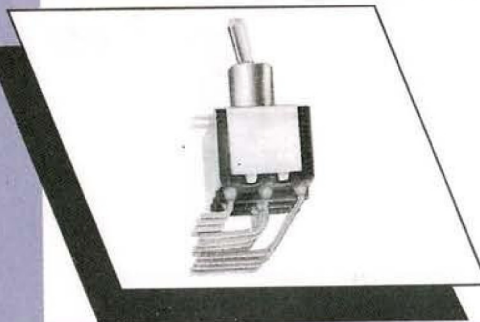
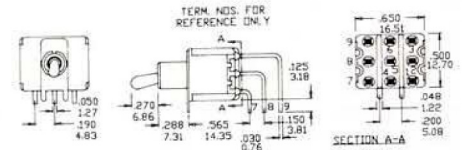
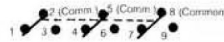

Model No.	Switching Position		
	ON	NONE	ON
PT8401	ON	NONE	ON
PT8403	ON	NONE	(ON)
PT8405	ON	OFF	ON
PT8407	(ON)	OFF	(ON)
PT8409	ON	OFF	(ON)
Term CONN	2-3, 5-6 8-9, 11-12	OPEN	2-1, 5-4 8-7, 11-10

Schematic

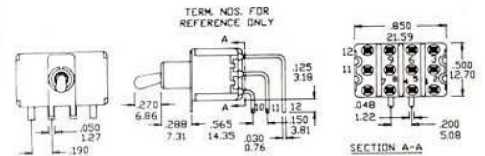

ACTUATOR (Available For Series T80)

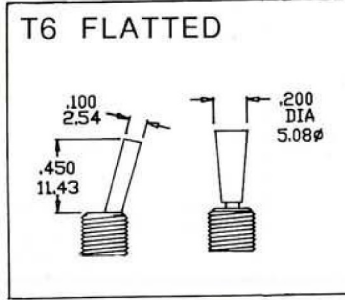
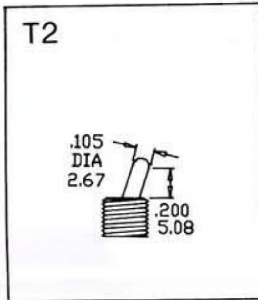
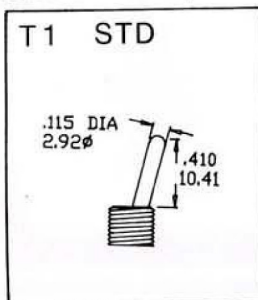

BUSHING OPTIONS

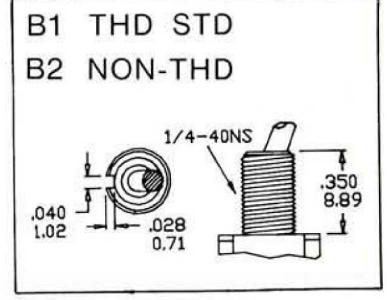

ACTUATOR OPTIONS (Available For Series PT80)

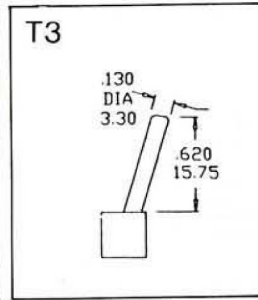
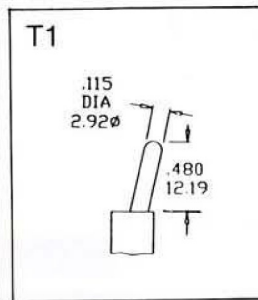
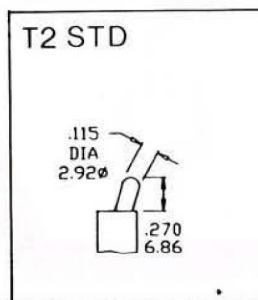

BUSHING OPTIONS

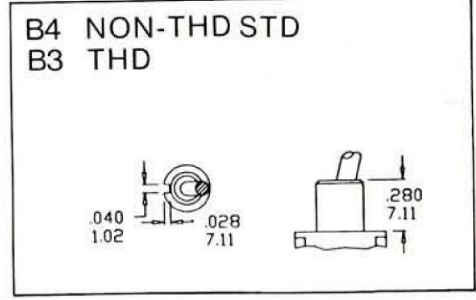

TERMINATION OPTIONS (Available For Series T80 or R80)

