

**SMB/DO-214AA**



**Features**

- ✧ UL Recognized File # E-326243
- ✧ For surface mounted application
- ✧ Low profile package
- ✧ Built-in strain relief
- ✧ Glass passivated junction
- ✧ Excellent clamping capability
- ✧ Fast response time: Typically less than 1.0ps from 0 volt to BV min
- ✧ Typical I<sub>R</sub> less than 1uA above 10V
- ✧ High temperature soldering guaranteed: 260°C / 10 seconds at terminals
- ✧ Plastic material used carried Underwriters Laboratory Flammability Classification 94V-0
- ✧ 600 watts peak pulse power capability with a 10/1000 us waveform
- ✧ Green compound with suffix "G" on packing code & prefix "G" on datecode

**Mechanical Data**

- ✧ Case: Molded plastic
- ✧ Terminals: Pure tin plated, lead free
- ✧ Polarity: Indicated by cathode band except bipolar
- ✧ Standard packaging: 12mm tape per EIA 383-481
- ✧ Weight: 0.093 gram

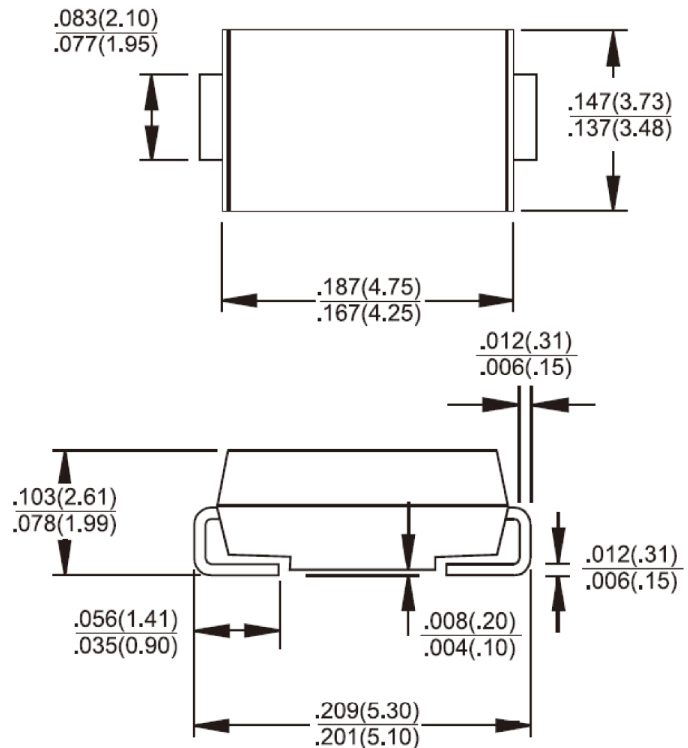

**Dimensions in inches and (millimeters)**

**Marking Diagram**



- XX = Specific Device Code
- G = Green Compound
- Y = Year
- M = Work Month

**Maximum Ratings and Electrical Characteristics**

Rating at 25 °C ambient temperature unless otherwise specified.

Single phase, half wave, 60 Hz, resistive or inductive load.

For capacitive load, derate current by 20%

Type Number	Symbol	Value	Unit
Peak Power Dissipation at T <sub>A</sub> =25°C, T <sub>p</sub> =1ms(Note 1)	P <sub>PK</sub>	Minimum 600	Watts
Steady State Power Dissipation	P <sub>D</sub>	3	Watts
Peak Forward Surge Current, 8.3ms Single Half Sine-wave Superimposed on Rated Load (JEDEC method)(Note 2, 3) - Unidirectional Only	I <sub>FSM</sub>	100	Amps
Maximum Instantaneous Forward Voltage at 50.0A for Unidirectional Only (Note 4)	V <sub>F</sub>	3.5 / 5.0	Volts
Typical Thermal Resistance (Note 5)	R <sub>θJC</sub>	10	°C/W
	R <sub>θJA</sub>	55	
Operating and Storage Temperature Range	T <sub>J</sub> , T <sub>STG</sub>	-65 to +150	°C

Note 1: Non-repetitive Current Pulse Per Fig. 3 and Derated above T<sub>A</sub>=25°C Per Fig. 2

Note 2: Mounted on 10.0mm<sup>2</sup> (.035mm Thick) Copper Pads to Each Terminal

Note 3: 8.3ms Single Half Sine-wave or Equivalent Square Wave, Duty Cycle=4 Pulses Per Minute Maximum

Note 4: V<sub>F</sub>=3.5V on SMBJ5.0 thru SMBJ90 Devices and V<sub>F</sub>=5.0V on SMBJ100 thru SMBJ170 Devices

Note 5: Measure on P.C.B. with 0.4" x 0.4" (10mm x 10mm) copper Pad Areas

**Devices for Bipolar Applications**

1. For Bidirectional Use C or CA Suffix for Types SMBJ5.0 through Types SMBJ170
2. Electrical Characteristics Apply in Both Directions

## RATINGS AND CHARACTERISTIC CURVES (SMBJ SERIES)

FIG. 1 PEAK PULSE POWER RATING CURVE

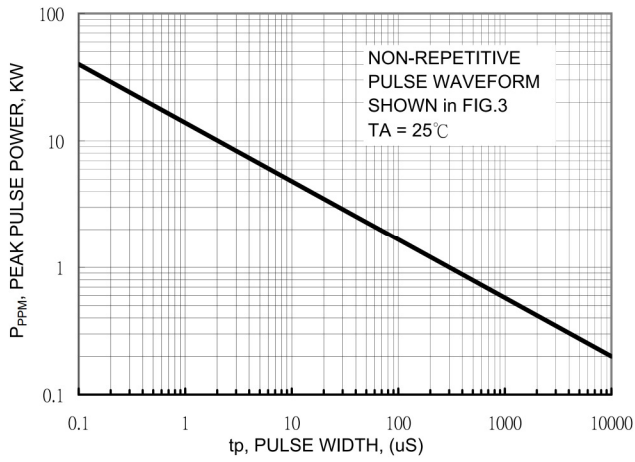

FIG.2 PULSE DERATING CURVE

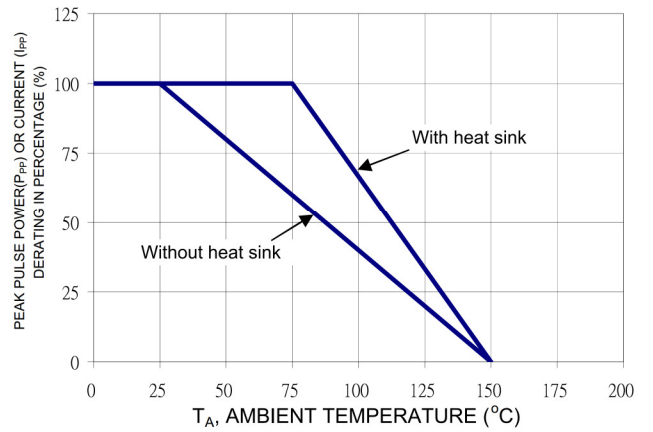

FIG. 3 CLAMPING POWER PULSE WAVEFORM

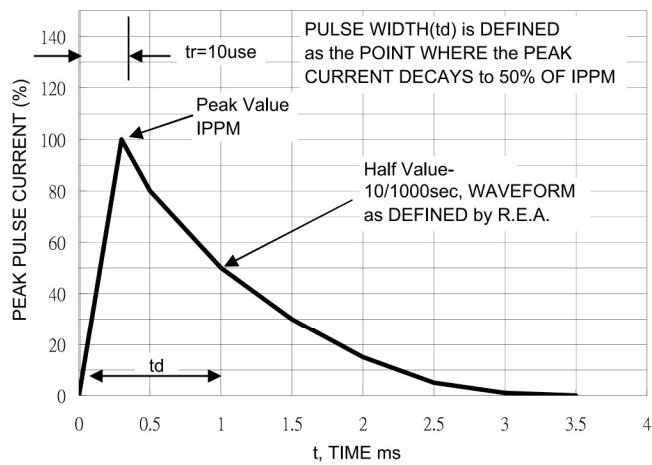

FIG. 4 MAXIMUM NON-REPETITIVE FORWARD SURGE CURRENT

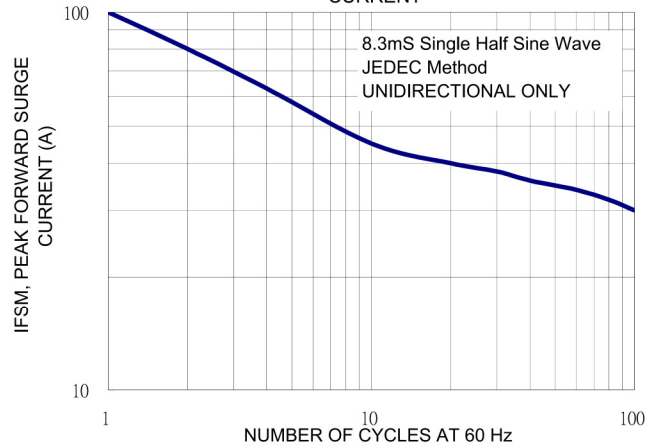
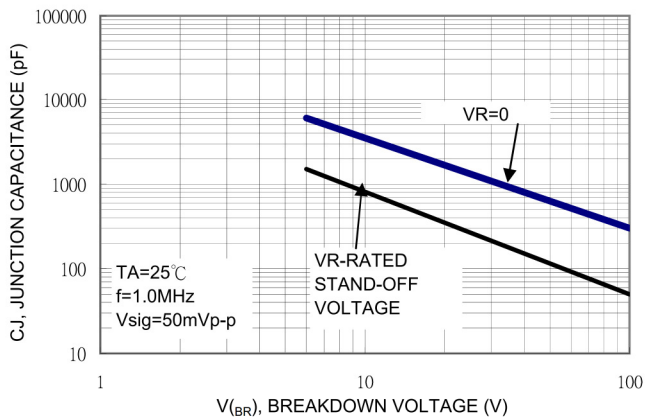

FIG. 5 TYPICAL JUNCTION CAPACITANCE



ELECTRICAL CHARACTERISTICS (T<sub>A</sub>=25°C unless otherwise noted)

Device	Device Marking Code	Breakdown Voltage (Note 1)		Test Current	Stand-Off Voltage	Maximum Reverse Leakage @ V <sub>WM</sub>	Maximum Peak Pulse Current	Maximum Clamping Voltage @ I <sub>PPM</sub>
		V <sub>BR</sub>		I <sub>T</sub>	V <sub>WM</sub>	I <sub>D</sub>	I <sub>PPM</sub>	V <sub>C</sub>
		V		mA	V	uA	A	V
		Min.	Max.				(Note 2)	
SMBJ5.0	KD	6.40	7.30	10	5.0	800	65.0	9.6
SMBJ5.0A	KE	6.40	7.00	10	5.0	800	68.0	9.2
SMBJ6.0	KF	6.67	8.15	10	6.0	800	55.0	11.4
SMBJ6.0A	KG	6.67	7.37	10	6.0	800	61.0	10.3
SMBJ6.5	KH	7.22	8.82	10	6.5	500	51.0	12.3
SMBJ6.5A	KK	7.22	7.98	10	6.5	500	56.0	11.2
SMBJ7.0	KL	7.78	9.51	10	7.0	200	47.0	13.3
SMBJ7.0A	KM	7.78	8.60	10	7.0	200	52.0	12.0
SMBJ7.5	KN	8.33	10.3	1	7.5	100	44.0	14.3
SMBJ7.5A	KP	8.33	9.21	1	7.5	100	48.0	12.9
SMBJ8.0	KQ	8.89	10.9	1	8.0	50	42.0	15.0
SMBJ8.0A	KR	8.89	9.83	1	8.0	50	46.0	13.6
SMBJ8.5	KS	9.44	11.5	1	8.5	10	39.0	15.9
SMBJ8.5A	KT	9.44	10.4	1	8.5	10	43.0	14.4
SMBJ9.0	KU	10.0	12.2	1	9.0	5	37.0	16.9
SMBJ9.0A	KV	10.0	11.1	1	9.0	5	40.0	15.4
SMBJ10	KW	11.1	13.6	1	10	5	33.0	18.8
SMBJ10A	KX	11.1	12.3	1	10	5	37.0	17.0
SMBJ11	KY	12.2	14.9	1	11	5	31.0	20.1
SMBJ11A	KZ	12.2	13.5	1	11	5	34.0	18.2
SMBJ12	LD	13.3	16.3	1	12	5	28.0	22.0
SMBJ12A	LE	13.3	14.7	1	12	5	31.0	19.9
SMBJ13	LF	14.4	17.6	1	13	5	26.0	23.8
SMBJ13A	LG	14.4	15.9	1	13	5	29.0	21.5
SMBJ14	LH	15.6	19.1	1	14	5	24.4	25.8
SMBJ14A	LK	15.6	17.2	1	14	5	27.0	23.2
SMBJ15	LL	16.7	20.4	1	15	5	23.1	26.9
SMBJ15A	LM	16.7	18.5	1	15	5	25.1	24.4
SMBJ16	LN	17.8	21.8	1	16	5	21.8	28.8
SMBJ16A	LP	17.8	19.7	1	16	5	24.2	26.0
SMBJ17	LQ	18.9	23.1	1	17	5	20.0	30.5
SMBJ17A	LR	18.9	20.9	1	17	5	22.8	27.6
SMBJ18	LS	20.0	24.4	1	18	5	19.5	32.2
SMBJ18A	LT	20.0	22.1	1	18	5	21.5	29.2
SMBJ20	LU	22.2	27.1	1	20	5	17.6	35.8
SMBJ20A	LV	22.2	24.5	1	20	5	19.4	32.4
SMBJ22	LW	24.4	29.8	1	22	5	15.0	39.4
SMBJ22A	LX	24.4	26.9	1	22	5	17.7	35.5
SMBJ24	LY	26.7	32.6	1	24	5	14.6	43.0
SMBJ24A	LZ	26.7	29.5	1	24	5	16.0	38.9
SMBJ26	MD	28.9	35.3	1	26	5	13.5	46.6
SMBJ26A	ME	28.9	31.9	1	26	5	14.9	42.1
SMBJ28	MF	31.1	38.0	1	28	5	12.6	50.0
SMBJ28A	MG	31.1	34.4	1	28	5	13.8	45.4
SMBJ30	MH	33.3	40.7	1	30	5	11.7	53.5
SMBJ30A	MK	33.3	36.8	1	30	5	13.0	48.4
SMBJ33	ML	36.7	44.9	1	33	5	10.6	59.0
SMBJ33A	MM	36.7	40.6	1	33	5	11.8	53.3
SMBJ36	MN	40.0	48.9	1	36	5	9.8	64.3
SMBJ36A	MP	40.0	44.2	1	36	5	10.8	58.1
SMBJ40	MQ	44.4	54.3	1	40	5	8.8	71.4
SMBJ40A	MR	44.4	49.1	1	40	5	9.7	64.5
SMBJ43	MS	47.8	58.4	1	43	5	8.2	76.7
SMBJ43A	MT	47.8	52.8	1	43	5	9.0	69.4

ELECTRICAL CHARACTERISTICS (T<sub>A</sub>=25°C unless otherwise noted)

Device	Device Marking Code	Breakdown Voltage (Note 1)		Test Current	Stand-Off Voltage	Maximum Reverse Leakage @ V <sub>WM</sub>	Maximum Peak Pulse Current	Maximum Clamping Voltage @ I <sub>PPM</sub>
		V <sub>BR</sub>		I <sub>T</sub>	V <sub>WM</sub>	I <sub>D</sub>	I <sub>PPM</sub>	V <sub>C</sub>
		V		mA	V	uA	A	V
		Min.	Max.				(Note 2)	
SMBJ45	MU	50.0	61.1	1	45	5	7.8	80.3
SMBJ45A	MV	50.0	55.3	1	45	5	8.6	72.7
SMBJ48	MW	53.3	65.1	1	48	5	7.3	85.5
SMBJ48A	MX	53.3	58.9	1	48	5	8.1	77.4
SMBJ51	MY	56.7	69.3	1	51	5	6.9	91.1
SMBJ51A	MZ	56.7	62.7	1	51	5	7.6	82.4
SMBJ54	ND	60.0	73.3	1	54	5	6.5	96.3
SMBJ54A	NE	60.0	66.3	1	54	5	7.2	87.1
SMBJ58	NF	64.4	78.7	1	58	5	6.1	103
SMBJ58A	NG	64.4	71.2	1	58	5	6.7	93.6
SMBJ60	NH	66.7	81.5	1	60	5	5.8	107
SMBJ60A	NK	66.7	73.7	1	60	5	6.5	96.8
SMBJ64	NL	71.1	86.9	1	64	5	5.5	114
SMBJ64A	NM	71.1	78.6	1	64	5	6.1	103
SMBJ70	NN	77.8	95.1	1	70	5	5.0	125
SMBJ70A	NP	77.8	86	1	70	5	5.5	113
SMBJ75	NQ	83.3	102	1	75	5	4.7	134
SMBJ75A	NR	83.3	92.1	1	75	5	5.2	121
SMBJ78	NS	86.7	106	1	78	5	4.5	139
SMBJ78A	NT	86.7	95.8	1	78	5	5.0	126
SMBJ85	NU	94.4	115	1	85	5	4.1	151
SMBJ85A	NV	94.4	104	1	85	5	4.6	137
SMBJ90	NW	100	122	1	90	5	3.9	160
SMBJ90A	NX	100	111	1	90	5	4.3	146
SMBJ100	NY	111	136	1	100	5	3.5	179
SMBJ100A	NZ	111	123	1	100	5	3.8	162
SMBJ110	PD	122	149	1	110	5	3.2	196
SMBJ110A	PE	122	135	1	110	5	3.5	177
SMBJ120	PF	133	163	1	120	5	2.9	214
SMBJ120A	PG	133	147	1	120	5	3.2	193
SMBJ130	PH	144	176	1	130	5	2.7	231
SMBJ130A	PK	144	159	1	130	5	3.0	209
SMBJ150	PL	167	204	1	150	5	2.3	266
SMBJ150A	PM	167	185	1	150	5	2.5	243
SMBJ160	PN	178	218	1	160	5	2.2	287
SMBJ160A	PP	178	197	1	160	5	2.4	259
SMBJ170	PQ	189	231	1	170	5	2.0	304
SMBJ170A	PR	189	209	1	170	5	2.2	275

## Notes:

1. V<sub>BR</sub> measure after I<sub>T</sub> applied for 300us, I<sub>T</sub>=square wave pulse or equivalent.
2. Surge current waveform per Figure. 3 and derate per Figure. 2
3. All terms and symbols are consistent with ANSI/IEEE C62.35.
4. For bidirectional use C or CA suffix for types SMBJ5.0 through SMBJ17C
5. For bipolar types having V<sub>WM</sub> of 10 volts(SMBJ8.0C) and under, the I<sub>D</sub> limit is doubled.

## TVS APPLICATION NOTES:

Transient Voltage Suppressors may be used at various points in a circuit to provide various degrees of protection. The following is a typical linear power supply with transient voltage suppressor units played at different points. All provide protection of the load.

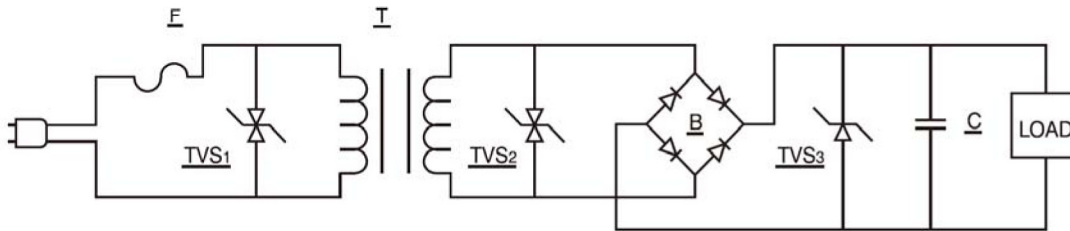

FIGURE 1

Transient Voltage Suppressor 1 provides maximum protection. However, the system will probably require replacement of the line fuse(F) since it provides a dominant portion of the series impedance when a surge is encountered.

Howevr, we do not recommend to use the TVS diode here, unless we can know the electric circuit impedance and the magnitude of surge rushed into the circuit. Otherwise the TVS diode is easy to be destroyed by voltage surge.

Transient Voltage Suppressor 2 provides execllent protection of circuitry excluding the transformer(T). However, since the transformer is a large part of the series impedance, the chance of the line fuse opening during the surge condition is reduced.

Transient Voltage Suppressor 3 provides the load with complete protection. It uses a unidirectional Transient Voltage Suppressor, which is a cost advantage. The series impedance now includes the line fuse, transformer, and bridge rectifier(B) so failure of the line fuse is further reduced. If onlt Transient Voltage Suppressor 3 is in use, then the bridge rectifier is unprotected and would require a higher voltage and current rating to prevent failure by transients.

Any combination of this three, or any one of these applivations, will prevent damage to the load. This would require varying trade-offs in power supply protection versus maintenance(changing the time fuse).

An additional method is to utilize the Transient Voltage Suppressor units as a controlled avalanche bridge. This reduces the parts count and incorporated the protection within the bridge rectifier.

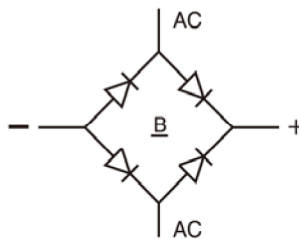

FIGURE 2

### RECOMMENDED PAD SIZES

The pad dimensions should be 0.010"(0.25mm) longer than the contact size, in the lead axis.  
This allows a solder filler to form, see figure below. Contact factort for soldering methods.

