

REV	MODIFICATION	DATE	DRAW
B	EN-10-0135	2010/01/29	TONY
C	EN-10-0204	2010/02/03	TONY

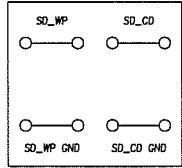

WITHOUT CARD

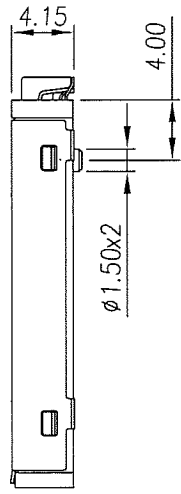
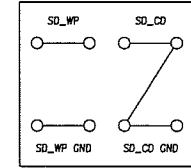

CARD INSERTED  
WRITE PROTECT : LOCK

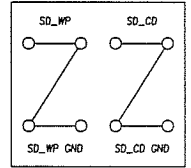

CARD INSERTED  
WRITE PROTECT : UNLOCK

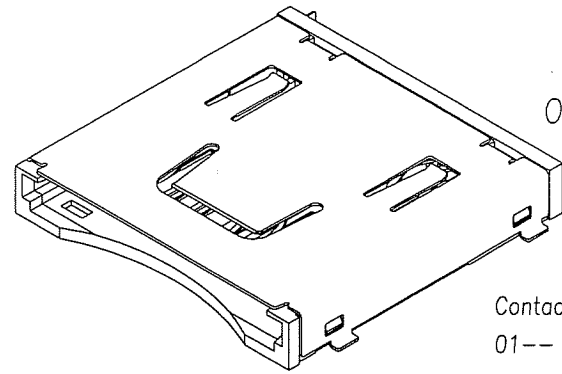

Ordering Information:  
AIO3X-122XXBTOX

Contact Area Plating:  
01-- G/F Gold Plating

PACKAGE TYPE :  
0 : TRAY  
1 : TAPE REEL  
T : SONY SS-00259

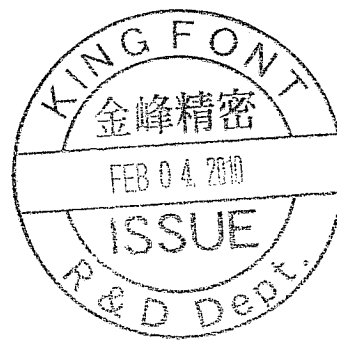

DIMENSION IN mm [Inch]		PROD. SPEC. SP-0109	KINGFONT KINGFONT PRECISION INDUSTRIAL CO., LTD.	
TOLERANCE UNLESS OTHERWISE SPECIFIED		PKG. SPEC. PPP-AIO-013/PPP-AIO-020	TITLE 3 IN 1 CONNECTOR MANUAL TYPE FOR MS,SD,MMC	CUSTOMER DRAWING
.X±0.30	X:±1*	APPROVE <i>Gam</i>	FILE NO. KFP-109	DWG NO. AIO3X-122XXBTOX
.XX±0.20	.X*±0.5*	CHECK <i>Sam</i>	SIZE A4	PROJ.  SHEET 1 / 2
.XXX±0.10	.XX*±0.25*	DRAW <i>Jerry</i>	SCALE 2:1	REV B

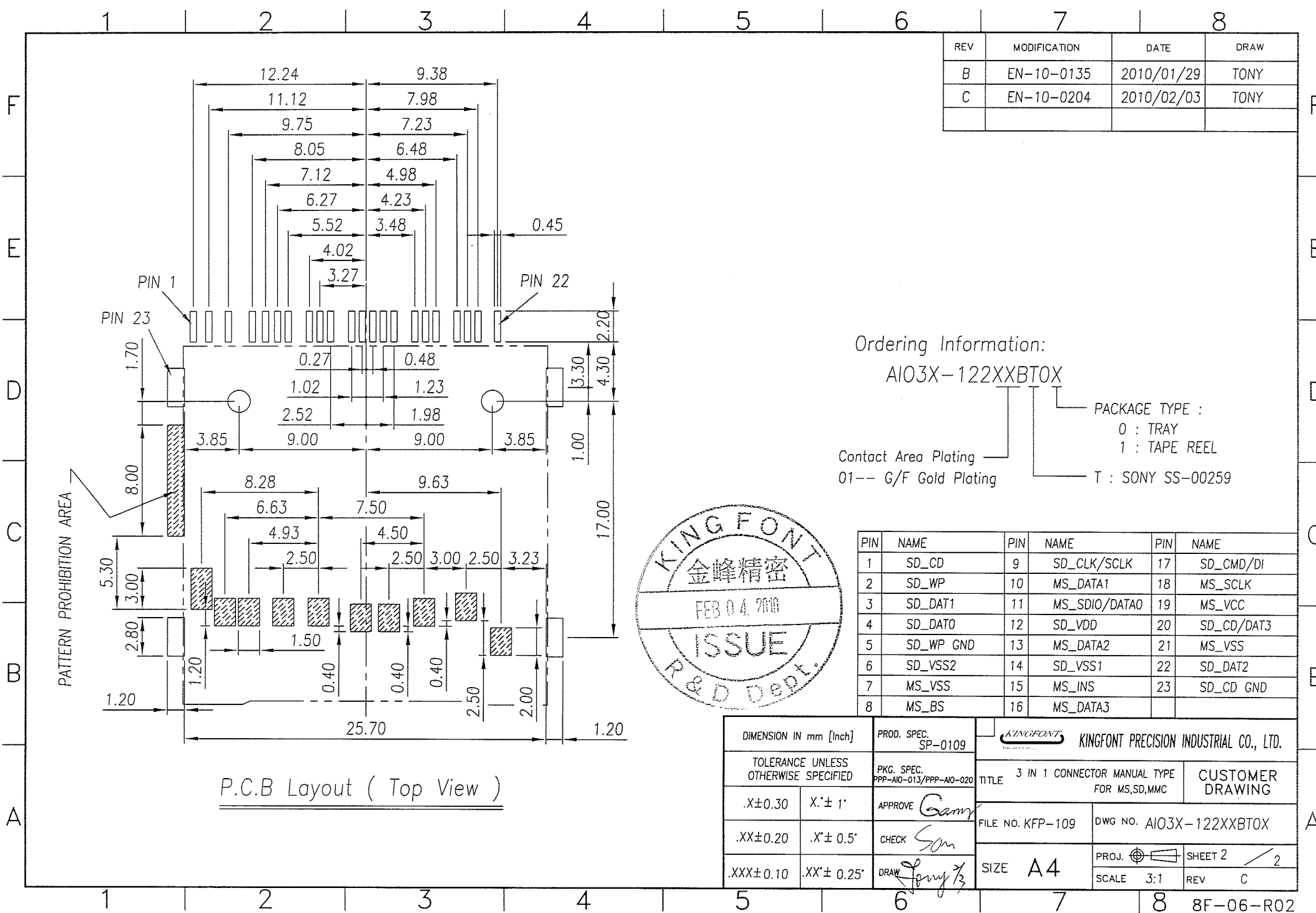

REV	MODIFICATION	DATE	DRAW
B	EN-10-0135	2010/01/29	TONY
C	EN-10-0204	2010/02/03	TONY

Ordering Information:

AIO3X-122XXBTOX

Contact Area Plating  
01-- G/F Gold Plating

PACKAGE TYPE :  
0 : TRAY  
1 : TAPE REEL  
T : SONY SS-00259

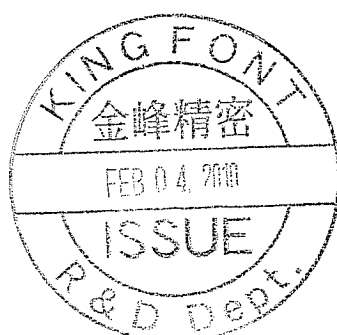

PIN	NAME	PIN	NAME	PIN	NAME
1	SD_CD	9	SD_CLK/SCLK	17	SD_CMD/DI
2	SD_WP	10	MS_DATA1	18	MS_SCLK
3	SD_DAT1	11	MS_SDIO/DATA0	19	MS_VCC
4	SD_DAT0	12	SD_VDD	20	SD_CD/DAT3
5	SD_WP GND	13	MS_DATA2	21	MS_VSS
6	SD_VSS2	14	SD_VSS1	22	SD_DAT2
7	MS_VSS	15	MS_INS	23	SD_CD GND
8	MS_BS	16	MS_DATA3		

P.C.B Layout ( Top View )

DIMENSION IN mm [Inch]		PROD. SPEC. SP-0109	KINGFONT PRECISION INDUSTRIAL CO., LTD.	
TOLERANCE UNLESS OTHERWISE SPECIFIED		PKG. SPEC. PPP-AIO-013/PPP-AIO-020	TITLE 3 IN 1 CONNECTOR MANUAL TYPE FOR MS,SD,MMC	CUSTOMER DRAWING
.X±0.30	X'± 1'	APPROVE <i>Gamy</i>	FILE NO. KFP-109	DWG NO. AIO3X-122XXBTOX
.XX±0.20	.X'± 0.5'	CHECK <i>Son</i>	SIZE A4	PROJ.  SHEET 2 / 2
.XXX±0.10	.XX'± 0.25'	DRAW <i>Gamy</i>	SCALE 3:1	REV C