



Product information GSA 3000 schwarz/black

Industrial Connecting Solutions:Rectangular Connectors:Valve Connectors (Type A -B -C):Type A:Receptacle Valve Connectors (DIN EN 175 301-803):GSA 3000 schwarz/black

<http://e-catalog.hirschmann.com/link/57078-24228-256261-256266-256270-276216-35136/en/conf/uistate>

Name	GSA 3000 schwarz/black
	
	appliance connector with retaining nut, 2 screws M 3 x 10 and 1 screw M 3 x 4, longitudinal slots, open nut
Delivery informations	
Availability	available
Product description	
Description	appliance connector with retaining nut, 2 screws M 3 x 10 and 1 screw M 3 x 4, longitudinal slots, open nut
Type	GSA 3000 schwarz/black
Order No.	932 597-100
Number of contacts	3 + PE
Standard	DIN EN 175 301-803-A
Housing Color	black
Construction type	A
Technical data	
Rated voltage	AC/DC 400 V
Rated current	16 A
Contact resistance	<= 4 mOhm
Type of termination	solder, holes for possibility of soldering on both sides (ground contacts: screw)
Mounting	screw
Material	
Contact surface material	Sn
Contact bearer material	PA
Housing material	PA
Environmental conditions	
Protection class (IEC 60529)	IP 65 (gasket necessary) (mated)
Pollution severity	3
Temperature range	-40 °C to +125 °C
Inflammability class	
Contact bearer	94 V-0
Approvals	
UR	UR
VDE	VDE
CSA	CSA
Packaging unit	
Packaging unit	200 pieces
Scope of delivery and accessories	
Accessories to order separately	(NBR) flat gasket GSA 200-4, Order no. 730 843-002; (EPDM) flat gasket GSA 200-7, Order no. 730 268-003



HIRSCHMANN

A BELDEN BRAND

Industrial Connecting Solutions:Rectangular Connectors:Valve Connectors (Type A -B -C):Type A:Receptacle Valve Connectors (DIN EN 175 301-803):GSA 3000 schwarz/black
<http://e-catalog.hirschmann.com/link/57078-24228-256261-256266-256270-276216-35136/en/conf/uistate>

Picture
Drawing

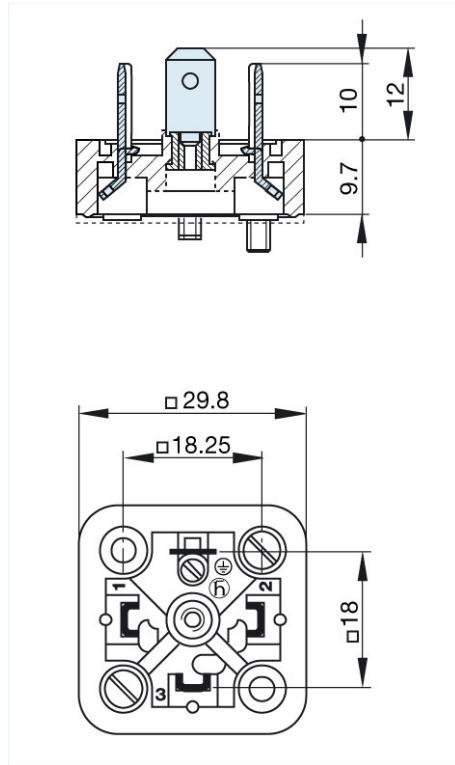

Belden Deutschland GmbH
Im Gewerbepark 2
58579 Schalksmühle
Germany
Phone: +49 7127/14-1806
E-Mail: icos-sales@belden.com

The information published in the websites has been compiled as carefully as possible. It is subject to alteration without notice in technical as well as in price-related/commercial respect. The complete information and data were available on user documentation. Mandatory information can only be obtained by a concrete query.