

G317 / G218

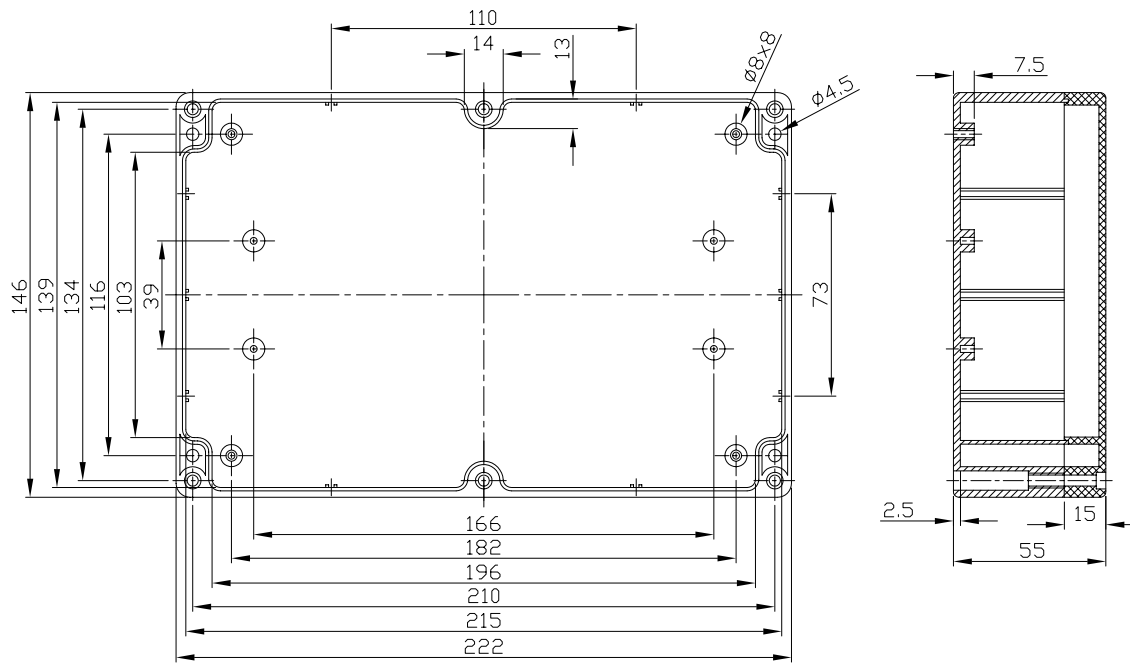

宣又實業有限公司
GAINTA INDUSTRIES LTD.

設計 DES'D BY	繪圖 DRA'D BY	核圖 CHK'D BY	比例 SCALE	日期 DATE	材質 MATE.	圖名 TITLE	圖號 DWG NO.	圖號 REVISID	說明 DESCRIPTION
					ABS,PC	G317,G218			