

SPEC No. DIS-H-204	SPECIFICATION HIGH-DIELECTRIC HIGH VOLTAGE CERAMIC CAPACITOR	Rev. No. 02	Page No. 1
-------------------------------------	-------------------------------------------------------------------------------	------------------------------	-----------------------------

Record of Revision

Date	Rev.No	Description	Issued by	Checked by	Remark
2010.02.03	rev.01	Production specification review	J.H Uhm	B.S. Min	
2011.06.28	rev.02	2-1. Type Designation" Halogen Free "추가	S.H PARK	H.S. CHI	
2012.06.13	rev.03	Temperature Characteristics review	W.C. JUNG	J.H. Park	

SPEC No.	SPECIFICATION	Rev. No.	Page No.
DIS-H-204	HIGH-DIELECTRIC HIGH VOLTAGE CERAMIC CAPACITOR	02	2

1. SCOPE

This specification is applied to high dielectric constant and temperature compensation ceramic capacitor.

■ Features

1. Small size and high capacitance
2. Coated with flame-retardant epoxy resin
(equivalent to UL94V-0 standard)
3. Taping available for automatic insertion.

2. Part Number for System

2-1. Type Designation

CK 3A YR 102 K F K H P07 C04 F C
 2-1-1 2-1-2 2-1-3 2-1-4 2-1-5 2-1-6 2-1-7 2-1-8 2-1-9 2-1-10 2-1-11 2-1-12

For lead type straight short lead, lead tolerance is only ± 0.3 mm available.

2-1-1. Type

CK : Epoxy coated High dielectric constant fixed ceramic capacitor.(class II)

2-1-2. Rating Voltage(DC)

3A : 1KV, 3D : 2KV, 3F : 3KV, 3J : 6KV

2-1-3. Temperature Characteristics

T.C	Temp. Char	
	-25°C ~ +85°C	+85°C ~ +125°C
R	Within ± 15 %	Within +15% ~ -30 %
B	Within ± 10 %	
E	Within +22% ~ -56 %	
F	Within +30% ~ -80 %	

Pre-heatment : Capacitor should be stored at $125 \pm 3^\circ\text{C}$ for 1 hr.,
then placed at room condition for 24 ± 2 hrs.

2-1-4. Nominal Capacitance

The nominal capacitance value in pF is expressed by three digit number.

The first two digits denote significant figure ; the last digit denotes the multiplier of 10 in pF of zero to follow. Ex) In case of 102 : $10 \times 10^2 = 1000\text{pF}$



SPEC No.	SPECIFICATION	Rev. No.	Page No.
DIS-H-204	HIGH-DIELECTRIC HIGH VOLTAGE CERAMIC CAPACITOR	02	3

2-1-5. Capacitance Tolerance.

K : ±10%	M : ±20%	P : -0 ~ +100%	Z : +80~-20%
----------	----------	----------------	--------------

2-1-6. Packing Style

B	Bulk Type
F	Taping Type "Flat Pack"

2-1-7. Lead Variation

K	Kink Type or Vertical Type
S	Straight Type

2-1-8. Halogen Free

H	Brominated & Chlorine-Based flame retardants Free
---	---------------------------------------------------

2-1-9. Lead Spacing (F)

Not mentioned	5.0 (-0.2/+0.8)
P07	7.5 ± 1.0
P10	10.0 ±1.0

2-1-10. Lead Cutting Length

Lead Type	Code	Length (L)
straight out kink vertical	C03	2.8 ± 0.3
	C04	3.2 ± 0.3
	C07	6.3 ± 0.5
	C10	10.0 ± 0.3
┘ Forming	C04	LEFT : 2.9+0.6 / RIGHT : 4.9+0.6
	C05	LEFT : 4.7+0.6 / RIGHT : 6.7+0.6
	C07	7.0 ± 0.3

* Straight Long Type : 20 ± 1.0

2-1-11. Lead "┘" Forming

F	Straight "┘" Forming
---	----------------------

2-1-12. Lead wire Material

C : Sn plated copper cover Steel-Wire, Lead Wire Plating thickness(3μm min)
(material: Fe)

SPEC No.	SPECIFICATION	Rev. No.	Page No.
DIS-H-204	HIGH-DIELECTRIC HIGH VOLTAGE CERAMIC CAPACITOR	02	4

3. Parts Numbering

Part Number	Temp Char	Capacitance (pF)	Tolerance (%)	Dimensions(mm)		
				D (max)	T (max)	Lead Spacing(F)
CK3AYR101K	R	100	±10	6.0	4.5	5.0 (-02/+0.8)
CK3AYR221K	R	220	±10	6.0	4.5	5.0 (-02/+0.8)
CK3AYR471K	R	470	±10	6.0	4.5	5.0 (-02/+0.8)
CK3AYR681K	R	680	±10	7.0	4.5	5.0 (-02/+0.8)
CK3AYR102K	R	1000	±10	8.0	4.5	5.0 (-02/+0.8)
CK3AYR222K	R	2200	±10	13.0	4.5	5.0 (-02/+0.8)
CK3AYR332K	R	3300	±10	16.0	4.5	7.5±1
CK3AYR472K	R	4700	±10	22.0	4.5	10.0±1
CK3DYR101K	R	100	±10	8.0	5.0	5.0 (-02/+0.8)
CK3DYR221K	R	220	±10	8.0	5.0	5.0 (-02/+0.8)
CK3DYR561K	R	560	±10	9.0	5.0	5.0 (-02/+0.8)
CK3DYR102K	R	1000	±10	10.0	5.0	7.5±1
CK3DYR152K	R	1500	±10	11.0	5.0	7.5±1
CK3AYB101K	B	100	±10	6.0	4.5	5.0 (-02/+0.8)
CK3AYB102K	B	1000	±10	7.0	4.5	5.0 (-02/+0.8)
CK3AYB152K	B	1500	±10	9.0	4.5	5.0 (-02/+0.8)
CK3AYB222K	B	2200	±10	9.0	4.5	5.0 (-02/+0.8)
CK3AYB332K	B	3300	±10	13.0	4.5	5.0 (-02/+0.8)
CK3AYB472K	B	4700	±10	16.0	4.5	7.5±1
CK3DYB101K	B	100	±10	8.0	5.0	5.0 (-02/+0.8)
CK3DYB221K	B	220	±10	8.0	5.0	5.0 (-02/+0.8)
CK3DYB102K	B	1000	±10	9.0	5.0	5.0 (-02/+0.8)
CK3DYB152K	B	1500	±10	10.0	5.0	7.5±1
CK3DYB222K	B	2200	±10	11.0	5.0	7.5±1
CK3DYB472K	B	4700	±10	16.0	5.0	10.0±1



SPEC No.	SPECIFICATION	Rev. No.	Page No.
DIS-H-204	HIGH-DIELECTRIC HIGH VOLTAGE CERAMIC CAPACITOR	02	5

Part Number	Temp Char	Capacitance (pF)	Tolerance (%)	Dimensions(mm)		
				D (max)	T (max)	Lead Spacing(F)
CK3FYB101K	B	100	±10	7.0	5.5	5.0 (-02/+0.8)
CK3FYB561K	B	560	±10	8.0	5.5	5.0 (-02/+0.8)
CK3FYB821K	B	820	±10	9.0	5.5	7.5±1
CK3FYB102K	B	1000	±10	10.0	5.5	7.5±1
CK3FYB152K	B	1500	±10	12.0	5.5	10.0±1
CK3FYB222K	B	2200	±10	13.0	5.5	10.0±1
CK3JYB471K	B	470	±10	8.0	6.0	7.5±1
CK3JYB681K	B	680	±10	9.0	6.0	7.5±1
CK3JYB102K	B	1000	±10	10.0	6.0	10.0±1
CK3AYE102P	E	1000	-0 ~ +100	6.0	4.5	5.0 (-02/+0.8)
CK3AYE222P	E	2200	-0 ~ +100	7.0	4.5	5.0 (-02/+0.8)
CK3AYE472P	E	4700	-0 ~ +100	9.0	4.5	5.0 (-02/+0.8)
CK3AYE103P	E	10000	-0 ~ +100	16.0	4.5	7.5±1
CK3DYE102P	E	1000	-0 ~ +100	8.0	5.0	5.0 (-02/+0.8)
CK3DYE222P	E	2200	-0 ~ +100	9.0	5.0	7.5±1
CK3FYE472P	E	4700	-0 ~ +100	12.0	5.5	10.0±1
CK3AYF103Z	F	10000	-20 ~ + 80	9.0	4.5	5.0 (-02/+0.8)
CK3DYF103Z	F	10000	-20 ~ + 80	16.0	5.0	10.0±1



SPEC No.	SPECIFICATION	Rev. No.	Page No.
DIS-H-204	HIGH-DIELECTRIC HIGH VOLTAGE CERAMIC CAPACITOR	02	6

4. Taping and Bulk Type

4-1. Taping Type

① 12.7 Pitch Straight

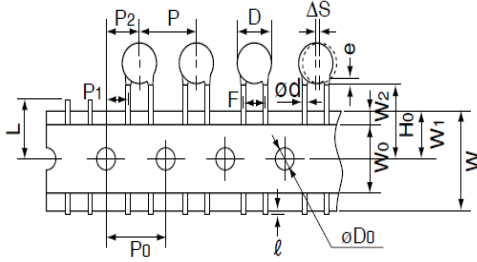

② 12.7 Pitch KINK

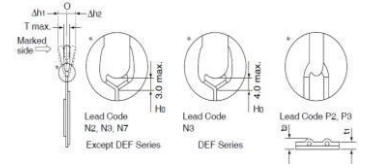
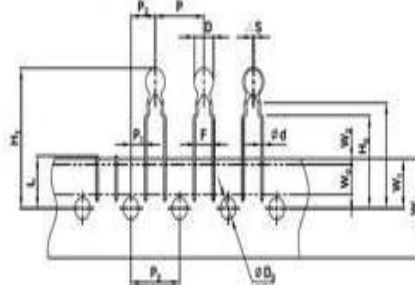

③ 15.0 Pitch Straight

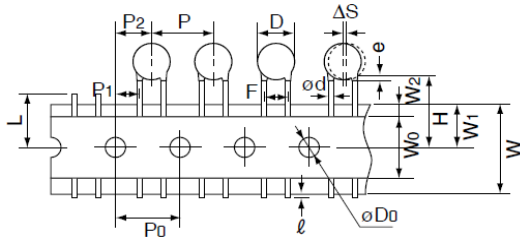

④ 15.0 Pitch KINK

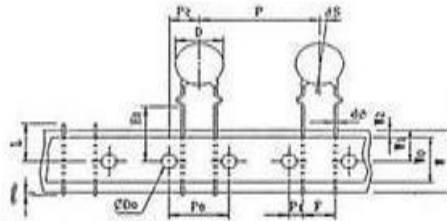

ITEM	CODE	Dimensions(mm)			
		①	②	③	④
Body Diameter	D	5.0 < D ≤ 11.0		13.0 Max	
Pitch of component	P	12.7±1.0		15.0±1.0	
Pitch of Sprocket Hole	P ₀	12.7±0.3		15.0±0.3	
Lead spacing	F	5.0 (-0.2/+0.8)		7.5±1.0	
Length from hole center to component center	P ₂	6.35±1.5		7.5±1.5	
Length from hole center to lead	P ₁	3.85±0.7		3.75±1.0	
Deviation along tape, left or right	Δs	0±1.0			
Carrier tape width	W	18.0 +0.8 ~ -0.2			
Position of sprocket hole	W ₁	9.0±0.5			
Lead distance between and bottom planes	H ₀ / H	17±1.0, 20±1.0			
Protrusion length	ℓ	+0.5 to -1.0			
Diameter of sprocket hole	φD ₀	4.0±0.2			
Lead diameter	φd	0.50, 0.55, 0.60 ±0.05			
Total tape thickness	t ₁	0.7±0.2			
Total thickness,tape and lead wire	t ₂	1.5 Max			
Body thickness	T	4.0 Max		6.0 Max	
Portion to cut in case of defect	L	12.0 Max			
Hold down tape width	W ₀	5.0 Min		7.0 Min	
Hold down tape position	W ₂	3.0 Max			

SPEC No.	SPECIFICATION	Rev. No.	Page No.
DIS-H-204	HIGH-DIELECTRIC HIGH VOLTAGE CERAMIC CAPACITOR	02	7

4-2. Bulk Type

straight

out Kink

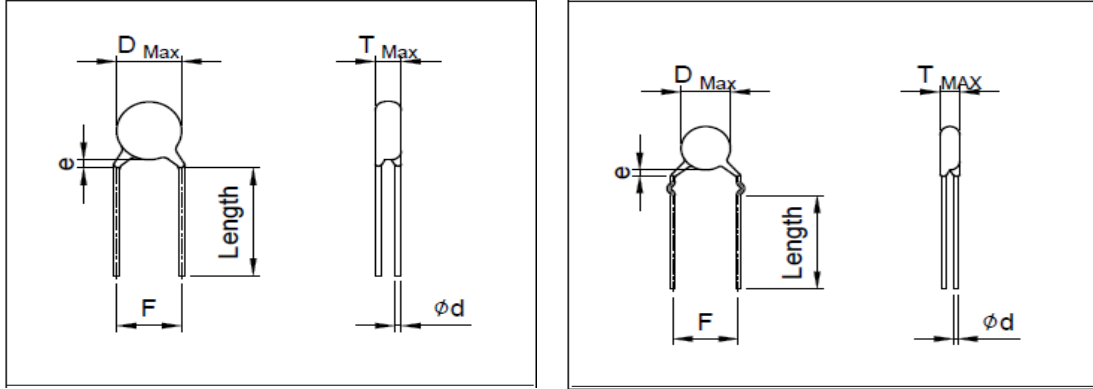

5. Standard Marking

MARKING ITEMS	EXAMPLE
1. TEMPERATURE CHARACTERISTICS	
2. NOMINAL CAPACITANCE	
3. TOLERANCE	
4. IN CASE OF DOT MARKING: Halogen Free	
5. RATED VOLTAGE	

6. Packing Specification

6.1. Taping Type

Type	PITCH	TAPING	
		IN BOX	OUT BOX
DC	12.7	2,000	12,000
	15.0	1,000	6,000

6-2. Bulk Type

Dia (DΦ)	Straight Long type		Forming Cutting type	
	Vinyl	In box	Vinyl	In box
6Φ	1,000	5,000	1,000	6,000
7Φ~8Φ	1,000	4,000	1,000	6,000
9Φ~10Φ	500	2,000	1,000	4,000
14Φ	500	2,000	500	2,000

SPEC No.	SPECIFICATION	Rev. No.	Page No.
DIS-H-204	HIGH-DIELECTRIC HIGH VOLTAGE CERAMIC CAPACITOR	02	8

7. Specification and Reliability Test Method

7-1 Capacitance

Capacitance shall be within specified limits when measured at a Voltage of 1Vrms and a frequency of 1KHz at 20±3°C.

7-2 Dissipation Factor tanδ(%)

The dissipation factor shall be within limits when measured at a Voltage 1Vrms and a frequency of 1KHz at 20±3°C.

table 1)

Temp.Char.	R	B	E	F
tanδ(%)	0.2% max	2.5% max	2.5% max	5.0% max

7-3 Withstand Voltage (between Terminals)

Capacitors shall be withstood the test voltage specified in the individual specification without damage or breakdown when measured 60Sec after application twice of rated voltage.

7-4 Withstand Voltage (between terminal and body)

Capacitors shall not be damage when rated voltege as below condition Applied both connected leads and body.
60Sec after appilcation twice of rated voltage.

7-5 Reliability Test

7-5-1 Temperature Charecteristics

The rate of capacitance variation shall be satisfied table 2) when Measured the capacitance within the temperature range of table 2).
(Standard temperature : 20±3°C)

table 2)

T.C	Temp. Char	RATE OF CAPACITANCE VARIATION
R	-25°C~+85°C	±15 %
	+85°C ~ +125°C	+15 ~ -30 %
B	-25°C~+85°C	±10%
E	-25°C~+85°C	+22%~-56%
F	-25°C~+85°C	+30%~-80%



SPEC No.	SPECIFICATION	Rev. No.	Page No.
DIS-H-204	HIGH-DIELECTRIC HIGH VOLTAGE CERAMIC CAPACITOR	02	9

7-5-2 Humidity Test

Shall be subjected to a temperature of $40\pm 3^{\circ}\text{C}$ and Relative humidity between 90~95% for 500 (0~+24) hours and the Maintained at normal temperature and humidity for a period of 4~24 hours the following table 3) shall be satisfied.

table 3)

TEMP. CHAR	R	B	E	F
Change Rate	$\pm 10\%$	$\pm 10\%$	$\pm 20\%$	$\pm 30\%$
Dissipation Factor (Tan δ %)	0.6%MAX	5% MAX	5% MAX	7.5% MAX
Insulation Resistance	3000M Ω MIN			

7-5-3 Humidity Loading Test

Capacitors shall be subjected to a temperature of $40\pm 3^{\circ}\text{C}$ and apply 100% of DC rated voltage, relative humidity between 90~95% after application rated voltage and limiting the charging and discharging current to 50mA for 500Hours and then tested within 4~24 hours the following table 4) shall be satisfied.

table 4)

TEMP. CHAR	R	B	E	F
Change Rate	$\pm 10\%$	$\pm 10\%$	$\pm 20\%$	$\pm 30\%$
Dissipation Factor(Tan δ %)	0.6%MAX	5% MAX	5% MAX	7.5% MAX
Insulation Resistance	3000M Ω MIN			



SPEC No.	SPECIFICATION	Rev. No.	Page No.
DIS-H-204	HIGH-DIELECTRIC HIGH VOLTAGE CERAMIC CAPACITOR	02	10

7-5-4 High Temperature Loading Test

Capacitors shall be subjected to a temperature of $85\pm 3^{\circ}\text{C}$ and apply 200% of DC rated voltage(application twice of rated voltage) and limit the charging and discharging current to 50mA for 1000Hours and then maintained a normal temperature and humidity for a period of 4~24 hours the following table 5) shall be satisfied.

table 5)

TEMP. CHAR	R	B	E	F
Change Rate	$\pm 10\%$	$\pm 10\%$	$\pm 20\%$	$\pm 30\%$
Dissipation Factor($\text{Tan}\delta\%$)	0.6%MAX	4% MAX	4% MAX	7.5% MAX
Insulation Resistance	3000M Ω MIN			

7-5-5 Thermal Shock Test

$-45^{\circ}\text{C}(30\text{min})\sim +125^{\circ}\text{C}(30\text{min})$, It is 100 Cycle operation to \rightarrow one Cycle (One hour) measure it after 12 to 24 hour, the following measurement satisfies table 6).

table 6)

TEMP. CHAR	R	B	E	F
Change Rate	$\pm 10\%$	$\pm 10\%$	$\pm 20\%$	$\pm 30\%$
Dissipation Factor($\text{Tan}\delta\%$)	0.6%MAX	4% MAX	4% MAX	7.5% MAX
Insulation Resistance	3000M Ω MIN			

7-5-6 Discharge Test (I)

Capacitors shall comply with two following requirements, after with standing 50 discharges from a 1000pF capacitor. Charged to potential of 10kv DC, with an interval of 5 seconds between successive discharge, as shown below.

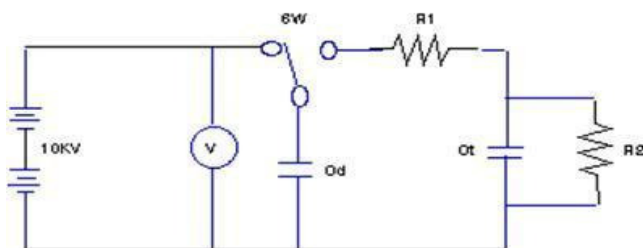

Ct : Capacitor under test

Cd: 0.001 μF

R1: 1000 Ω

R2: 100M Ω

Visual examination No mechanical damage

Dielectric withstanding voltage . . . The voltage as satisfied in the individual specification

SPEC No.	SPECIFICATION	Rev. No.	Page No.
DIS-H-204	HIGH-DIELECTRIC HIGH VOLTAGE CERAMIC CAPACITOR	02	11

7-5-7 Discharge Test (II)

Capacitors shall comply with the following requirements, after with standing four discharges from a dump capacitor charged to a voltage value that when discharged places a potential of 5 Kv across the capacitor test, with an interval of 5 seconds between successive discharges, as shown in the circuit below.

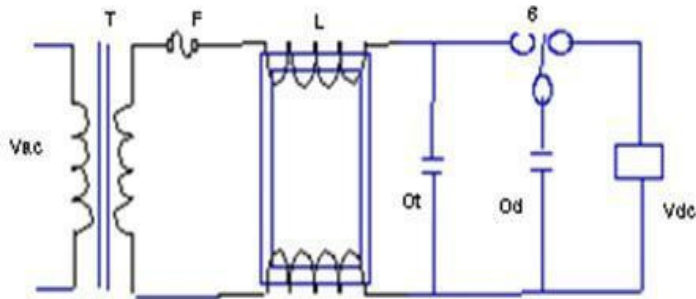

- Vdc : Variable direct-current voltage source
- L : Choke coil of approximately 3mH and 0.03Ω
- S : High-voltage switch
- Cd : Dump capacitor
- Ct : Capacitor under test

The direct current supply is to DE adjusted to potential in accordance with the following

CAPACITANCE VALUE OF CT	0~0.005μF	0.0051~0.05μF
CAPACITANCE VALUE OF CD	0.005μF	0.05μF
DISSIPATION FACTOR OF CD	0.5 % max	0.5 % max
APPEARANCE	The cheesecloth around capacitors shall not glow of flame	

$$VDC = \frac{5000 (Cd + Ct)}{Cd} (V)$$

CD : dump capacitor 0.005μF(Ct≥0.05μF) OR 0.05μF(0.005μF < Ct ≤ 0.05μF)

CT : capacitance under test

SPEC No.	SPECIFICATION	Rev. No.	Page No.
DIS-H-204	HIGH-DIELECTRIC HIGH VOLTAGE CERAMIC CAPACITOR	02	12

8. 9. Capacitor structure & Material

8-1 Capacitor structure

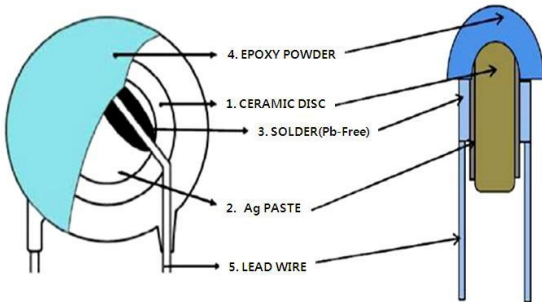

No.	Material	Substance
1	Dielectric Powder	BaTiO ₃ , TiO ₂
2	Ag Plate	Ag
3	Solder (Lead Free)	Sn, Ag, Cu
4	Epoxy Resin	Pel-Powder
5	Lead Wire	CP (Steel-Wire)

* Lead Wire Plating thickness : 3μm min (material: Tin)

8-2 Lead wire

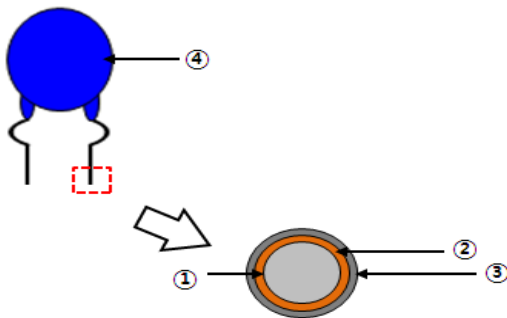

No.	Material
①	Steel-wire (Fe)
②	Copper (Cu)
③	Tin (Sn)
④	Epoxy Resin

8-3 Pb free showing



8-4 Halogen free showing



* The Mark is showing to all Box