

REV.	DESCRIPTION	DRAWN	CHECKED	APPROVED
A	NEW RELEASE	DGQ 06/14/11'		

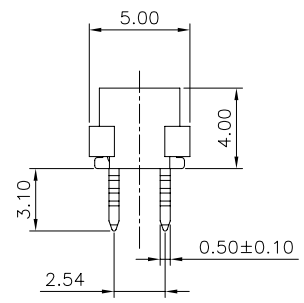
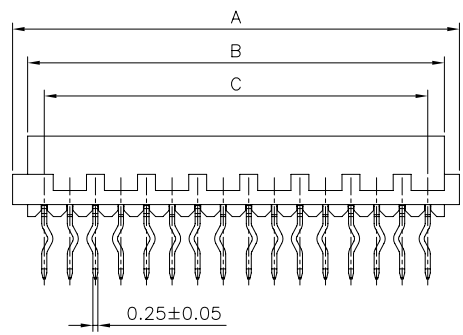
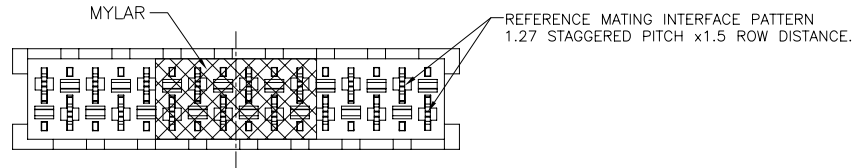

NOTES:

- MATERIAL
  - INSULATOR:PBT(UL 94V-0).
  - CONTACT: 0.25t COPPER ALLOY.
- SPECIFICATION
  - TEMPERATURE RANGE:-40~105°C.
  - CONTACT RESISTANCE:30mΩ max.
  - INSULATION RESISTANCE:1000MΩ min.
  - DIELECTRIC WITHSTANDING VOLTAGE:AC 500V PER MINUTE.

3. PRODUCT NUMBER CODE:

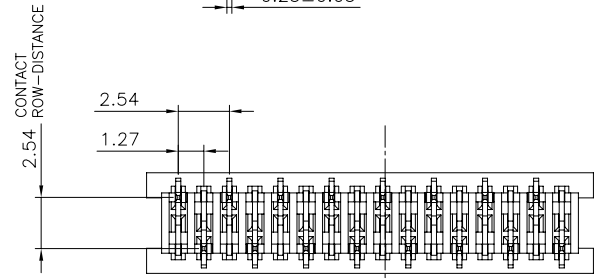
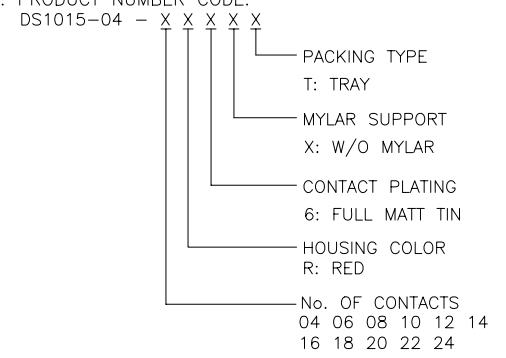

POSITIONS	DIM A	DIM B	DIM C
4	6.96	5.46	3.81
6	9.50	8.00	6.35
8	12.04	10.54	8.89
10	14.58	13.08	11.43
12	17.12	15.62	13.97
14	19.66	18.16	16.51
16	22.20	20.70	19.05
18	24.74	23.24	21.59
20	27.28	25.78	24.13
22	29.82	28.32	26.67
24	32.36	30.86	29.21

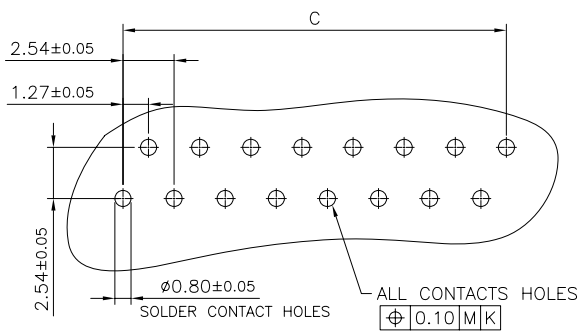
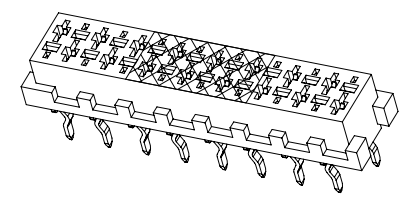

GENERAL TOLERANCE	ANGLE TOLERANCE	PROJECTION		TITLE	MICRO MATCH FEMALE VERTICAL THROUGH HOLE TYPE
X. ±0.60	X. ±5°	UNITS	mm		
.X ±0.38	.X ±3°	SHEET SIZE	A4	SERIES	DS1015-04 SERIES
.XX ±0.25	.XX ±2°	<b>晨翔电子有限公司</b> <b>CONNFLY CONNFLY ELECTRONIC CO. LTD</b>			
DRAWING TYPE	CUSTOMER				
SCALE	1:1 SHEET 1 OF 1				
DRAWING NO.	C-DS1015-04-XXXX-A				