

FEATURES

Fast 12-Bit ADC with 6 μ s Conversion Time
8-Pin Mini-DIP and SOIC
Single Supply Operation
High Speed, Easy-to-Use, Serial Interface
On-Chip Track/Hold Amplifier
Selection of Input Ranges
 ± 10 V for AD7893-10
 ± 2.5 V for AD7893-3
 0 V to +2.5 V for AD7893-2
 0 V to +5 V for AD7893-5
Low Power: 25 mW typ

FUNCTIONAL BLOCK DIAGRAM

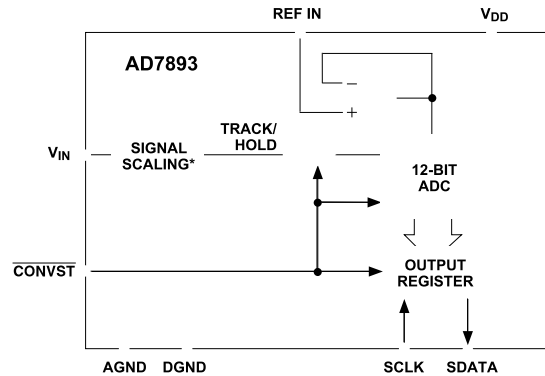

*AD7893-5, AD7893-10, AD7893-3

GENERAL DESCRIPTION

The AD7893 is a fast, 12-bit ADC that operates from a single +5 V supply and is housed in a small 8-pin mini-DIP and 8-pin SOIC. The part contains a 6 μ s successive approximation A/D converter, an on-chip track/hold amplifier, an on-chip clock and a high speed serial interface.

Output data from the AD7893 is provided via a high speed, serial interface port. This two-wire serial interface has a serial clock input and a serial data output with the external serial clock accessing the serial data from the part.

In addition to traditional dc accuracy specifications such as linearity, full-scale and offset errors, the AD7893 is also specified for dynamic performance parameters, including harmonic distortion and signal-to-noise ratio.

The part accepts an analog input range of ± 10 V (AD7893-10), ± 2.5 V (AD7893-3), 0 V to +5 V (AD7893-5) or 0 V to +2.5 V (AD7893-2) and operates from a single +5 V supply, consuming only 25 mW typical.

The AD7893 is fabricated in Analog Devices' Linear Compatible CMOS (LC²MOS) process, a mixed technology process that combines precision bipolar circuits with low power CMOS logic. The part is available in a small, 8-pin, 0.3" wide, plastic or hermetic dual-in-line package (mini-DIP) and in an 8-pin, small outline IC (SOIC).

REV. E

Information furnished by Analog Devices is believed to be accurate and reliable. However, no responsibility is assumed by Analog Devices for its use, nor for any infringements of patents or other rights of third parties which may result from its use. No license is granted by implication or otherwise under any patent or patent rights of Analog Devices.

PRODUCT HIGHLIGHTS

- Fast, 12-Bit ADC in 8-Pin Package**
 The AD7893 contains a 6 μ s ADC, a track/hold amplifier, control logic and a high speed serial interface, all in an 8-pin package. This offers considerable space saving over alternative solutions.
- Low Power, Single Supply Operation**
 The AD7893 operates from a single +5 V supply and consumes only 25 mW. This low power, single supply operation makes it ideal for battery powered or portable applications.
- High Speed Serial Interface**
 The part provides high speed serial data and serial clock lines, allowing for an easy, two-wire serial interface arrangement.

AD7893—SPECIFICATIONS (V_{DD} = +5 V, AGND = DGND = 0 V, REF IN = +2.5 V. All specifications T_{MIN} to T_{MAX} unless otherwise noted.)

Parameter	A Versions ¹	B Versions	S Version	Units	Test Conditions/Comments
DYNAMIC PERFORMANCE					
Signal to (Noise + Distortion) Ratio ² @ +25°C	70	70	70	dB min	f _{IN} = 10 kHz Sine Wave, f _{SAMPLE} = 117 kHz
Total Harmonic Distortion (THD) ²	-80	-80	-80	dB max	f _{IN} = 10 kHz Sine Wave, f _{SAMPLE} = 117 kHz
Peak Harmonic or Spurious Noise ²	-80	-80	-80	dB max	f _{IN} = 10 kHz Sine Wave, f _{SAMPLE} = 117 kHz
Intermodulation Distortion (IMD) ²					f _a = 9 kHz, f _b = 9.5 kHz, f _{SAMPLE} = 117 kHz
2nd Order Terms	-80	-80	-80	dB max	
3rd Order Terms	-80	-80	-80	dB max	
DC ACCURACY					
Resolution	12	12	12	Bits	
Minimum Resolution for which No Missing Codes are Guaranteed	12	12	12	Bits	
Relative Accuracy ²	±1	±1/2	±1	LSB max	
Differential Nonlinearity ²	±1	±1	±1	LSB max	
Positive Full-Scale Error ²	±3	±1.5	±3	LSB max	
AD7893-2, AD7893-5 Unipolar Offset Error	±4	±3	±4	LSB max	
AD7893-10, AD7893-3 Negative Full-Scale Error ²	±3	±1.5	±3	LSB max	
Bipolar Zero Error	±4	±2	±4	LSB max	
ANALOG INPUT					
AD7893-10					
Input Voltage Range	±10	±10	±10	Volts	
Input Resistance	16	16	16	kΩ min	
AD7893-3					
Input Voltage Range	±2.5	±2.5	±2.5	Volts	
Input Resistance	4	4	4	kΩ min	
AD7893-5					
Input Voltage Range	0 to +5	0 to +5	0 to +5	Volts	
Input Resistance	9	9	9	kΩ min	
AD7893-2					
Input Voltage Range	0 to +2.5	0 to +2.5	0 to +2.5	Volts	
Input Current	500	500	500	nA max	
REFERENCE INPUT					
REF IN Input Voltage Range	2.375/2.625	2.375/2.625	2.375/2.625	V min/V max	2.5 V ± 5%
Input Current	2	2	10	μA max	
Input Capacitance ³	10	10	10	pF max	
LOGIC INPUTS					
Input High Voltage, V _{INH}	2.4	2.4	2.4	V min	V _{DD} = 5 V ± 5%
Input Low Voltage, V _{INL}	0.8	0.8	0.8	V max	V _{DD} = 5 V ± 5%
Input Current, I _{IN}	±10	±10	±10	μA max	V _{IN} = 0 V to V _{DD}
Input Capacitance, C _{IN} ³	10	10	10	pF max	
LOGIC OUTPUTS					
Output High Voltage, V _{OH}	4.0	4.0	4.0	V min	I _{SOURCE} = 200 μA
Output Low Voltage, V _{OL}	0.4	0.4	0.4	V max	I _{SINK} = 1.6 mA
Output Coding					
AD7893-10, AD7893-3	2s Complement				
AD7893-2, AD7893-5	Straight (Natural) Binary				
CONVERSION RATE					
Conversion Time	6	6	6	μs max	
Track/Hold Acquisition Time ²	1.5	1.5	1.5	μs max	
POWER REQUIREMENTS					
V _{DD}	+5	+5	+5	V nom	±5% for Specified Performance
I _{DD}	9	9	9	mA max	
Power Dissipation	45	45	45	mW max	Typically 25 mW

NOTES

¹Temperature Ranges are as follows: A, B Versions: -40°C to +85°C, S Version: -55°C to +125°C.

²See Terminology.

³Sample tested @ +25°C to ensure compliance.

Specifications subject to change without notice.

TIMING CHARACTERISTICS^{1, 2} ($V_{DD} = +5\text{ V}$, $AGND = DGND = 0\text{ V}$, $REF\ IN = +2.5\text{ V}$)

Parameter	A, B Versions	S Version	Units	Test Conditions/Comments
t_1	50	50	ns min	CONVST Pulse Width
t_2	60	70	ns min	SCLK High Pulse Width
t_3	30	40	ns min	SCLK Low Pulse Width
t_4^3	50	60	ns max	SCLK Rising Edge to Data Valid Delay
t_5^4	10	10	ns min	Bus Relinquish Time after Falling Edge of SCLK
	100	100	ns max	

NOTES

¹ Sample tested at +25°C to ensure compliance. All input signals are measured with $t_r = t_f = 1\text{ ns}$ (10% to 90% of +5 V) and timed from a voltage level of +1.6 V.

² See Figure 5.

³ Measured with the load circuit of Figure 1 and defined as the time required for an output to cross 0.8 V or 2.4 V.

⁴ Derived from the measured time taken by the data outputs to change 0.5 V when loaded with the circuit of Figure 1. The measured number is then extrapolated back to remove the effects of charging or discharging the 50 pF capacitor. This means that the time, t_5 , quoted in the timing characteristics is the true bus relinquish time of the part and, as such, is independent of external bus loading capacitances.

ABSOLUTE MAXIMUM RATINGS*

($T_A = +25^\circ\text{C}$ unless otherwise noted)

V_{DD} to AGND -0.3 V to +7 V

V_{DD} to DGND -0.3 V to +7 V

Analog Input Voltage to AGND

AD7893-10, AD7893-5 $\pm 17\text{ V}$

AD7893-2, AD7893-3 -5 V, +10 V

Reference Input Voltage to AGND . . . -0.3 V to $V_{DD} + 0.3\text{ V}$

Digital Input Voltage to DGND -0.3 V to $V_{DD} + 0.3\text{ V}$

Digital Output Voltage to DGND -0.3 V to $V_{DD} + 0.3\text{ V}$

Operating Temperature Range

Commercial (A, B Versions) -40°C to $+85^\circ\text{C}$

Extended (S Version) -55°C to $+125^\circ\text{C}$

Storage Temperature Range -65°C to $+150^\circ\text{C}$

Junction Temperature $+150^\circ\text{C}$

Plastic DIP Package, Power Dissipation 450 mW

θ_{JA} Thermal Impedance $130^\circ\text{C}/\text{W}$

Lead Temperature (Soldering, 10 sec) $+260^\circ\text{C}$

Cerdip Package, Power Dissipation 450 mW

θ_{JA} Thermal Impedance $125^\circ\text{C}/\text{W}$

Lead Temperature (Soldering, 10 sec) $+300^\circ\text{C}$

SOIC Package, Power Dissipation 450 mW

θ_{JA} Thermal Impedance $170^\circ\text{C}/\text{W}$

Lead Temperature, Soldering

Vapor Phase (60 sec) $+215^\circ\text{C}$

Infrared (15 sec) $+220^\circ\text{C}$

*Stresses above those listed under "Absolute Maximum Ratings" may cause permanent damage to the device. This is a stress rating only; functional operation of the device at these or any other conditions above those listed in the operational sections of this specification is not implied. Exposure to absolute maximum rating conditions for extended periods may affect device reliability.

CAUTION

ESD (electrostatic discharge) sensitive device. Electrostatic charges as high as 4000 V readily accumulate on the human body and test equipment and can discharge without detection. Although the AD7893 features proprietary ESD protection circuitry, permanent damage may occur on devices subjected to high energy electrostatic discharges. Therefore, proper ESD precautions are recommended to avoid performance degradation or loss of functionality.

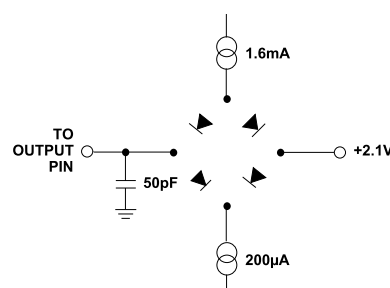

Figure 1. Load Circuit for Access Time and Bus Relinquish Time



AD7893

PIN FUNCTION DESCRIPTION

Pin No.	Pin Mnemonic	Description
1	REF IN	Voltage Reference Input. An external reference source should be connected to this pin to provide the reference voltage for the AD7893's conversion process. The REF IN input is buffered on-chip. The nominal reference voltage for correct operation of the AD7893 is +2.5 V.
2	V _{IN}	Analog Input Channel. The analog input range is ±10 V (AD7893-10), ±2.5 V (AD7893-3), 0 V to +5 V (AD7893-5) and 0 V to +2.5 V (AD7893-2).
3	AGND	Analog Ground. Ground reference for track/hold, comparator and DAC.
4	SCLK	Serial Clock Input. An external serial clock is applied to this input to obtain serial data from the AD7893. A new serial data bit is clocked out on the rising edge of this serial clock, and data is valid on the falling edge. The serial clock input should be taken low at the end of the serial data transmission.
5	SDATA	Serial Data Output. Serial data from the AD7893 is provided at this output. The serial data is clocked out by the rising edge of SCLK and is valid on the falling edge of SCLK. Sixteen bits of serial data are provided with four leading zeros followed by the 12 bits of conversion data. On the sixteenth falling edge of SCLK, the SDATA line is disabled (three-stated). Output data coding is twos complement for the AD7893-10 and AD7893-3, straight binary for the AD7893-2 and AD7893-5.
6	DGND	Digital Ground. Ground reference for digital circuitry.
7	CONVST	Convert Start. Edge-triggered logic input. On the falling edge of this input, the serial clock counter is reset to zero. On the rising edge of this input, the track/hold goes into its hold mode and conversion is initiated.
8	V _{DD}	Positive supply voltage, +5 V ± 5%.

PIN CONFIGURATION DIP and SOIC

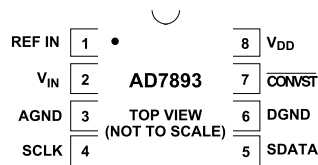

ORDERING GUIDE

Model	Temperature Range	Linearity Error	SNR	Package Options*
AD7893AN-2	-40°C to +85°C	±1 LSB	70 dB	N-8
AD7893BN-2	-40°C to +85°C	±1/2 LSB	72 dB	N-8
AD7893AR-2	-40°C to +85°C	±1 LSB	70 dB	SO-8
AD7893BR-2	-40°C to +85°C	±1/2 LSB	72 dB	SO-8
AD7893SQ-2	-55°C to +125°C	±1 LSB	70 dB	Q-8
AD7893AN-5	-40°C to +85°C	±1 LSB	70 dB	N-8
AD7893BN-5	-40°C to +85°C	±1/2 LSB	72 dB	N-8
AD7893AR-5	-40°C to +85°C	±1 LSB	70 dB	SO-8
AD7893BR-5	-40°C to +85°C	±1/2 LSB	72 dB	SO-8
AD7893SQ-5	-55°C to +125°C	±1 LSB	70 dB	Q-8
AD7893AN-10	-40°C to +85°C	±1 LSB	70 dB	N-8
AD7893BN-10	-40°C to +85°C	±1/2 LSB	72 dB	N-8
AD7893AR-10	-40°C to +85°C	±1 LSB	70 dB	SO-8
AD7893BR-10	-40°C to +85°C	±1/2 LSB	72 dB	SO-8
AD7893SQ-10	-55°C to +125°C	±1 LSB	70 dB	Q-8
AD7893AR-3	-40°C to +85°C	±1 LSB	70 dB	SO-8

*N = Plastic DIP, Q = Cerdip, SO = SOIC.

TERMINOLOGY**Signal to (Noise + Distortion) Ratio**

This is the measured ratio of signal to (noise + distortion) at the output of the A/D converter. The signal is the rms amplitude of the fundamental. Noise is the rms sum of all nonfundamental signals up to half the sampling frequency ($f_s/2$), excluding dc. The ratio is dependent upon the number of quantization levels in the digitization process; the more levels, the smaller the quantization noise. The theoretical signal to (noise + distortion) ratio for an ideal N-bit converter with a sine wave input is given by:

$$\text{Signal to (Noise + Distortion)} = (6.02N + 1.76) \text{ dB}$$

Thus for a 12-bit converter, this is 74 dB.

Total Harmonic Distortion

Total harmonic distortion (THD) is the ratio of the rms sum of harmonics to the fundamental. For the AD7893, it is defined as:

$$\text{THD (dB)} = 20 \log \frac{\sqrt{V_2^2 + V_3^2 + V_4^2 + V_5^2 + V_6^2}}{V_1}$$

where V_1 is the rms amplitude of the fundamental and V_2 , V_3 , V_4 , V_5 and V_6 are the rms amplitudes of the second through the sixth harmonics.

Peak Harmonic or Spurious Noise

Peak harmonic or spurious noise is defined as the ratio of the rms value of the next largest component in the ADC output spectrum (up to $f_s/2$ and excluding dc) to the rms value of the fundamental. Normally, the value of this specification is determined by the largest harmonic in the spectrum, but for parts where the harmonics are buried in the noise floor, it will be a noise peak.

Intermodulation Distortion

With inputs consisting of sine waves at two frequencies, f_a and f_b , any active device with nonlinearities will create distortion products at sum and difference frequencies of $m f_a \pm n f_b$ where $m, n = 0, 1, 2, 3$, etc. Intermodulation terms are those for which neither m nor n are equal to zero. For example, the second order terms include $(f_a + f_b)$ and $(f_a - f_b)$, while the third order terms include $(2 f_a + f_b)$, $(2 f_a - f_b)$, $(f_a + 2 f_b)$ and $(f_a - 2 f_b)$.

The AD7893 is tested using the CCIF standard where two input frequencies near the top end of the input bandwidth are used. In this case, the second and third order terms are of different significance. The second order terms are usually distanced in frequency from the original sine waves, while the third order terms are usually at a frequency close to the input frequencies. As a result, the second and third order terms are specified separately. The calculation of the intermodulation distortion is per the THD specification where it is the ratio of the rms sum of the individual distortion products to the rms amplitude of the fundamental expressed in dBs.

Relative Accuracy

Relative accuracy or endpoint nonlinearity is the maximum deviation from a straight line passing through the endpoints of the ADC transfer function.

Differential Nonlinearity

This is the difference between the measured and the ideal 1 LSB change between any two adjacent codes in the ADC.

Positive Full-Scale Error (AD7893-10)

This is the deviation of the last code transition (01 . . . 110 to 01 . . . 111) from the ideal $4 \times \text{REF IN} - 1 \text{ LSB}$ (AD7893-10 $\pm 10 \text{ V}$ range) after the Bipolar Zero Error has been adjusted out.

Positive Full-Scale Error (AD7893-3)

This is the deviation of the last code transition (01 . . . 110 to 01 . . . 111) from the ideal (REF IN - 1 LSB) after the Bipolar Zero Error has been adjusted out.

Positive Full-Scale Error (AD7893-5)

This is the deviation of the last code transition (11 . . . 110 to 11 . . . 111) from the ideal ($2 \times \text{REF IN} - 1 \text{ LSB}$) after the Unipolar Offset Error has been adjusted out.

Positive Full-Scale Error (AD7893-2)

This is the deviation of the last code transition (11 . . . 110 to 11 . . . 111) from the ideal (REF IN - 1 LSB) after the Unipolar Offset Error has been adjusted out.

Bipolar Zero Error (AD7893-10, $\pm 10 \text{ V}$; AD7893-3, $\pm 2.5 \text{ V}$)

This is the deviation of the midscale transition (all 0s to all 1s) from the ideal 0 V (AGND).

Unipolar Offset Error (AD7893-2, AD7893-5)

This is the deviation of the first code transition (00 . . . 000 to 00 . . . 001) from the ideal 1 LSB.

Negative Full-Scale Error (AD7893-10)

This is the deviation of the first code transition (10 . . . 000 to 10 . . . 001) from the ideal $-4 \times \text{REF IN} + 1 \text{ LSB}$ (AD7893-10 $\pm 10 \text{ V}$ range) after Bipolar Zero Error has been adjusted out.

Negative Full-Scale Error (AD7893-3)

This is the deviation of the first code transition (10 . . . 000 to 10 . . . 001) from the ideal ($-\text{REF IN} + 1 \text{ LSB}$) after Bipolar Zero Error has been adjusted out.

Track/Hold Acquisition Time

Track/Hold acquisition time is the time required for the output of the track/hold amplifier to reach its final value, within $\pm 1/2 \text{ LSB}$, after the end of conversion (the point at which the track/hold returns to track mode). It also applies to situations where there is a step input change on the input voltage applied to the V_{IN} input of the AD7893. This means that the user must wait for the duration of the track/hold acquisition time after the end of conversion or after a step input change to V_{IN} before starting another conversion, to ensure that the part operates to specification.

AD7893

CONVERTER DETAILS

The AD7893 is a fast, 12-bit single supply A/D converter. It provides the user with signal scaling (AD7893-10), track/hold, A/D converter and serial interface logic functions on a single chip. The A/D converter section of the AD7893 consists of a conventional successive-approximation converter based on an R-2R ladder structure. The signal scaling on the AD7893-10, AD7893-5 and AD7893-3 allows the part to handle ± 10 V, 0 V to +5 V and ± 2.5 V input signals, respectively, while operating from a single +5 V supply. The AD7893-2 accepts an analog input range of 0 V to +2.5 V. The part requires an external +2.5 V reference. The reference input to the part is buffered on-chip.

A major advantage of the AD7893 is that it provides all of the above functions in an 8-pin package, either 8-pin mini-DIP or SOIC. This offers the user considerable space saving advantages over alternative solutions. The AD7893 typically consumes only 25 mW, making it ideal for battery-powered applications.

Conversion is initiated on the AD7893 by pulsing the CONVST input. On the rising edge of CONVST, the on-chip track/hold goes from track-to-hold mode and the conversion sequence is started. The conversion clock for the part is generated internally using a laser-trimmed clock oscillator circuit. Conversion time for the AD7893 is 6 μ s, and the track/hold acquisition time is 1.5 μ s. To obtain optimum performance from the part, the read operation should not occur during the conversion or during 600 ns prior to the next conversion. This allows the part to operate at throughput rates up to 117 kHz and to achieve data sheet specifications. The part can operate at higher throughput rates (up to 133 kHz) with slightly degraded performance (see Timing and Control section).

CIRCUIT DESCRIPTION

Analog Input Section

The AD7893 is offered as four part types: the AD7893-10, which handles a ± 10 V input voltage range; the AD7893-3, which handles a ± 2.5 V input voltage range; the AD7893-5, which handles a 0 V to +5 V input range; and the AD7893-2, which handles a 0 V to +2.5 V input voltage range.

Figure 2 shows the analog input section for the AD7893-10, AD7893-5 and AD7893-3. The analog input range of the AD7893-10 is ± 10 V into an input resistance of typically 33 k Ω . The analog input range of the AD7893-3 is ± 2.5 V into an input resistance of typically 12 k Ω . The input range on the AD7893-5 is 0 V to +5 V into an input resistance of typically 11 k Ω . This input is benign with no dynamic charging currents, as the resistor stage is followed by a high input impedance stage of the track/hold

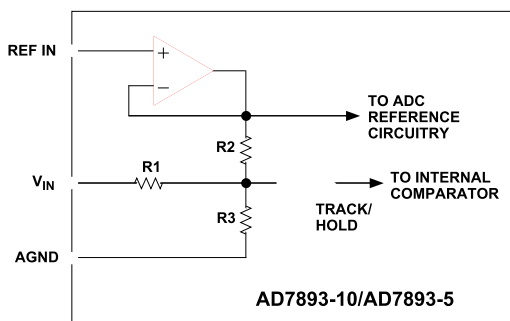

Figure 2. AD7893-10/AD7893-3/AD7893-5 Analog Input Structure

amplifier. For the AD7893-10, $R_1 = 30$ k Ω ; $R_2 = 7.5$ k Ω and $R_3 = 10$ k Ω . For the AD7893-3, $R_1 = R_2 = 6.5$ k Ω , and R_3 is open circuit. For the AD7893-5, R_1 and $R_3 = 5$ k Ω while R_2 is open-circuit.

For the AD7893-10 and AD7893-3, the designed code transitions occur on successive integer LSB values (i.e., 1 LSB, 2 LSBs, 3 LSBs . . .). Output coding is twos complement binary with 1 LSB = FS/4096. The ideal input/output transfer function for the AD7893-10 and AD7893-3 is shown in Table I.

Table I. Ideal Input/Output Code Table for the AD7893-10/AD7893-3

Analog Input ¹	Digital Output Code Transition
+FSR/2 – 1 LSB ²	011 . . . 110 to 011 . . . 111
+FSR/2 – 2 LSBs	011 . . . 101 to 011 . . . 110
+FSR/2 – 3 LSBs	011 . . . 100 to 011 . . . 101
AGND + 1 LSB	000 . . . 000 to 000 . . . 001
AGND	111 . . . 111 to 000 . . . 000
AGND – 1 LSB	111 . . . 110 to 111 . . . 111
–FSR/2 + 3 LSBs	100 . . . 010 to 100 . . . 011
–FSR/2 + 2 LSBs	100 . . . 001 to 100 . . . 010
–FSR/2 + 1 LSB	100 . . . 000 to 100 . . . 001

NOTES

¹FSR is full-scale range and is 20 V (AD7893-10) and = 5 V (AD7893-3) with REF IN = +2.5 V.

²1 LSB = FSR/4096 = 4.883 mV (AD7893-10) and 1.22 mV (AD7893-3) with REF IN = +2.5 V.

For the AD7893-5, the designed code transitions occur again on successive integer LSB values. Output coding is straight (natural) binary with 1 LSB = FS/4096 = 5 V/4096 = 1.22 mV. The ideal input/output transfer function for the AD7893-5 is shown in Table II.

The analog input section for the AD7893-2 contains no biasing resistors, and the V_{IN} pin drives the input directly to the track/hold amplifier. The analog input range is 0 V to +2.5 V into a high impedance stage, with an input current of less than 500 nA. This input is benign, with no dynamic charging currents. Once again, the designed code transitions occur on successive integer LSB values. Output coding is straight (natural) binary with 1 LSB = FS/4096 = 2.5 V/4096 = 0.61 mV. Table II also shows the ideal input/output transfer function for the AD7893-2.

Table II. Ideal Input/Output Code Table for AD7893-2/AD7893-5

Analog Input ¹	Digital Output Code Transition
+FSR – 1 LSB ²	111 . . . 110 to 111 . . . 111
+FSR – 2 LSB	111 . . . 101 to 111 . . . 110
+FSR – 3 LSB	111 . . . 100 to 111 . . . 101
AGND + 3 LSB	000 . . . 010 to 000 . . . 011
AGND + 2 LSB	000 . . . 001 to 000 . . . 010
AGND + 1 LSB	000 . . . 000 to 000 . . . 001

NOTES

¹FSR is Full-Scale Range and is 5 V for AD7893-5 and 2.5 V for AD7893-2 with REF IN = +2.5 V.

²1 LSB = FSR/4096 and is 1.22 mV for AD7893-5 and 0.61 mV for AD7893-2 with REF IN = +2.5 V.

Track/Hold Section

The track/hold amplifier on the analog input of the AD7893 allows the ADC to accurately convert an input sine wave of full-scale amplitude to 12-bit accuracy. The input bandwidth of the track/hold is greater than the Nyquist rate of the ADC, even when the ADC is operated at its maximum throughput rate of 117 kHz (i.e., the track/hold can handle input frequencies in excess of 58 kHz).

The track/hold amplifier acquires an input signal to 12-bit accuracy in less than 1.5 μs . The operation of the track/hold is essentially transparent to the user. The track/hold amplifier goes from its tracking mode to its hold mode at the start of conversion (i.e., the rising edge of $\overline{\text{CONVST}}$). The aperture time for the track/hold (i.e., the delay time between the external $\overline{\text{CONVST}}$ signal and the track/hold actually going into hold) is typically 15 ns. At the end of conversion (6 μs after the rising edge of $\overline{\text{CONVST}}$) the part returns to its tracking mode. The acquisition time of the track/hold amplifier begins at this point.

Reference Input

The reference input to the AD7893 is a buffered on-chip with a maximum reference input current of 1 μA . The part is specified with a +2.5 V reference input voltage. Errors in the reference source will result in gain errors in the AD7893's transfer function and will add to the specified full-scale errors on the part. On the AD7893-10 it will also result in an offset error injected in the attenuator stage. Suitable reference sources for the AD7893 include the AD780 and AD680 precision +2.5 V references.

Timing and Control Section

Figure 3 shows the timing and control sequence required to obtain optimum performance from the AD7893. In the sequence shown, conversion is initiated on the rising edge of $\overline{\text{CONVST}}$, and new data from this conversion is available in the output register of the AD7893 6 μs later. Once the read operation has taken place, a further 600 ns should be allowed before the next rising edge of $\overline{\text{CONVST}}$ to optimize the settling of the track/hold amplifier before the next conversion is initiated. With the serial clock frequency at its maximum of 8.33 MHz, the achievable throughput rate for the part is 6 μs (conversion time) plus 1.92 μs (read time) plus 0.6 μs (acquisition time). This results in a minimum throughput time of 8.52 μs (equivalent to a throughput rate of 117 kHz).

The read operation consists of sixteen serial clock pulses to the output shift register of the AD7893. After sixteen serial clock pulses the shift register is reset and the SDATA line is three-stated. If there are more serial clock pulses after the sixteenth clock, the shift register will be moved on past its reset state; however, the shift register will be reset again on the falling edge of the $\overline{\text{CONVST}}$ signal to ensure that the part returns to a known state every conversion cycle. As a result, a read operation from the output register should not straddle across the falling edge of $\overline{\text{CONVST}}$ as the output shift register will be reset in the middle of the read operation, and the data read back into the microprocessor will appear invalid.

The throughput rate of the part can be increased by reading data during conversion. If the data is read during conversion, a throughput time of 6 μs (conversion time) plus 1.5 μs is achieved. This minimum throughput time of 7.5 μs is achieved with a slight reduction in performance from the AD7893. The signal to (noise + distortion) number is likely to degrade by approximately 1.5 dB while the code flicker from the part will also increase (see AD7893 PERFORMANCE section).

Because the AD7893 is provided in an 8-pin package to minimize board space, the number of pins available for interfacing is very limited. As a result, no status signal is provided from the AD7893 to indicate when conversion is complete. In many applications, this will not be a problem as the data can be read from the AD7893 during conversion or after conversion; however, applications that want to achieve optimum performance from the AD7893 will have to ensure that the data read does not occur during conversion or during 600 ns prior to the rising edge of $\overline{\text{CONVST}}$. This can be achieved in two ways. The first is to ensure in software that the read operation is not initiated until 6 μs after the rising edge of $\overline{\text{CONVST}}$. This will only be possible if the software knows when the $\overline{\text{CONVST}}$ command is issued. The second scheme would be to use the $\overline{\text{CONVST}}$ signal as both the conversion start signal and an interrupt signal. The simplest way to do this would be to generate a square wave signal for $\overline{\text{CONVST}}$ with high and low times of 6 μs (see Figure 4). Conversion is initiated on the rising edge of $\overline{\text{CONVST}}$. The falling edge of $\overline{\text{CONVST}}$ occurs 6 μs later and can be used as either an active low or falling, edge-triggered interrupt signal to tell the processor to read the data from the AD7893. Provided that the read operation is completed 600 ns before the rising edge of $\overline{\text{CONVST}}$, the AD7893 will operate to specification.

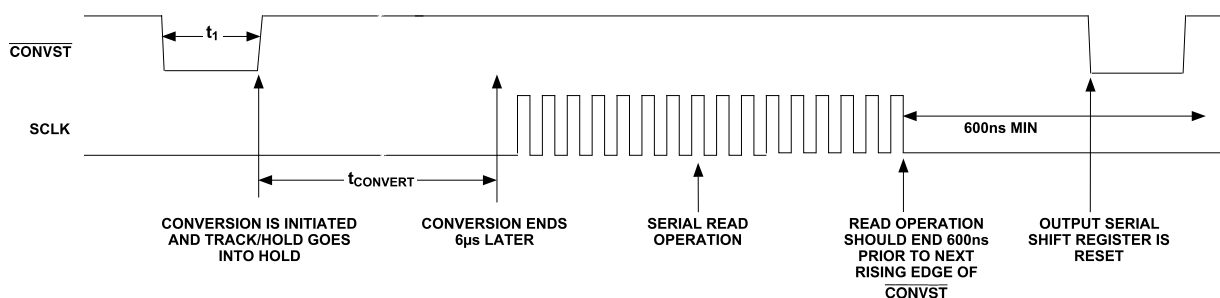

Figure 3. Timing Sequence for Optimum Performance from the AD7893

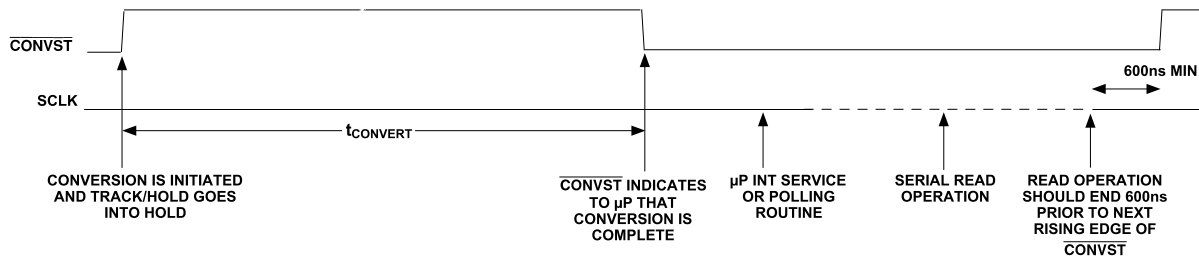

Figure 4. $\overline{\text{CONVST}}$ Used as Status Signal

This scheme limits the throughput rate to 12 μs minimum; however, depending on the response time of the microprocessor to the interrupt signal and the time taken by the processor to read the data, this may be the fastest the system could have operated. In any case, the $\overline{\text{CONVST}}$ signal does not have to have a 50:50 duty cycle. This can be tailored to optimize the throughput rate of the part for a given system.

Alternatively, the $\overline{\text{CONVST}}$ signal can be used as a normal narrow pulse width. The rising edge of $\overline{\text{CONVST}}$ can be used as an active high or rising edge-triggered interrupt. A software delay of 6 μs can then be implemented before data is read from the part.

Serial Interface

The serial interface to the AD7893 consists of just two wires, a serial clock input (SCLK) and the serial data output (SDATA). This allows for an easy to use interface to most microcontrollers, DSP processors and shift registers.

Figure 5 shows the timing diagram for the read operation to the AD7893. The serial clock input (SCLK) provides the clock source for the serial interface. Serial data is clocked out from the SDATA line on the rising edge of this clock and is valid on the falling edge of SCLK. Sixteen clock pulses must be provided to the part to access to full conversion result. The AD7893 provides four leading zeros followed by the 12-bit conversion result starting with the MSB (DB11). The last data bit to be clocked out on the final rising clock edge is the LSB (DB0). On the sixteenth falling edge of SCLK, the SDATA line is disabled (three-stated). After this last bit has been clocked out, the SCLK input should return low and remain low until the next serial data read operation. If there are extra clock pulses after the sixteenth

clock, the AD7893 will start over again with outputting data from its output register, and the data bus will no longer be three-stated even when the clock stops. Provided that the serial clock has stopped before the next falling edge of $\overline{\text{CONVST}}$, the AD7893 will continue to operate correctly with the output shift register being reset on the falling edge of $\overline{\text{CONVST}}$; however, the SCLK line must be low when $\overline{\text{CONVST}}$ goes low in order to reset the output shift register correctly.

The serial clock input does not have to be continuous during the serial read operation. The sixteen bits of data (four leading zeros and 12 bit conversion result) can be read from the AD7893 in a number of bytes; however, the SCLK input must remain low between the two bytes.

Normally, the output register is updated at the end of conversion. If a serial read from the output register is in progress when conversion is complete; however, the updating of the output register is deferred. In this case, the output register is updated when the serial read is completed. If the serial read has not been completed before the next falling edge of $\overline{\text{CONVST}}$, the output register will be updated on the falling edge of $\overline{\text{CONVST}}$, and the output shift register count is reset. In applications where the data read has been started and not completed before the falling edge of $\overline{\text{CONVST}}$, the user must provide a $\overline{\text{CONVST}}$ pulse width of greater than 1.5 μs to ensure correct setup of the AD7893 before the next conversion is initiated. In applications where the output update takes place either at the end of conversion or at the end of a serial read that is completed 1.5 μs before the rising edge of $\overline{\text{CONVST}}$, the normal pulse width of 50 ns minimum applies to $\overline{\text{CONVST}}$.

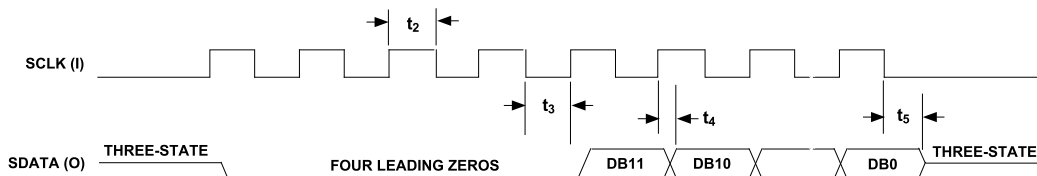

Figure 5. Data Read Operation

The AD7893 counts the serial clock edges to know which bit from the output register should be placed on the SDATA output. To ensure that the part does not lose synchronization, the serial clock counter is reset on the falling edge of the $\overline{\text{CONVST}}$ input, provided the SCLR line is low. The user should ensure that a falling edge on the $\overline{\text{CONVST}}$ input does not occur while a serial data read operation is in progress.

MICROPROCESSOR/MICROCONTROLLER INTERFACE

The AD7893 provides a two-wire serial interface that can be used for connection to the serial ports of DSP processors and microcontrollers. Figures 6 through 9 show the AD7893 interfaced to a number of different microcontrollers and DSP processors. The AD7893 accepts an external serial clock and, as a result, in all interfaces shown here, the processor/controller is configured as the master, providing the serial clock with the AD7893 configured as the slave in the system.

AD7893-8051 Interface

Figure 6 shows an interface between the AD7893 and the 8XC51 microcontroller. The 8XC51 is configured for its Mode 0 serial interface mode. The diagram shows the simplest form of the interface where the AD7893 is the only part connected to the serial port of the 8XC51 and, therefore, no decoding of the serial read operations is required. It also makes no provisions for monitoring when conversion is complete on the AD7893.

Either of these two tasks can readily be accomplished with minor modifications to the interface. To chip select the AD7893 in systems where more than one device is connected to the 8XC51's serial port, a port bit configured as an output from one of the 8XC51's parallel ports can be used to gate on or off the serial clock to the AD7893. A simple AND function on this port bit and the serial clock from the 8XC51 will provide this function. The port bit should be high to select the AD7893 and low when it is not selected.

To monitor the conversion time on the AD7893, a scheme such as previously outlined with $\overline{\text{CONVST}}$ can be used. This can be implemented in two ways. One is to connect the $\overline{\text{CONVST}}$ line to another parallel port bit that is configured as an input. This port bit can then be polled to determine when conversion is complete. An alternative is to use an interrupt driven system, in which case the $\overline{\text{CONVST}}$ line should be connected to the INT1 input of the 8XC51.

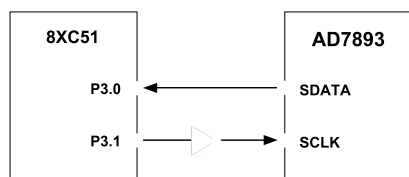

Figure 6. AD7893 to 8XC51 Interface

The serial clock rate from the 8XC51 is limited to significantly less than the allowable input serial clock frequency with which the AD7893 can operate. As a result, the time to read data from the part will actually be longer than the conversion time of the part. This means that the AD7893 cannot run at its maximum throughput rate when used with the 8XC51.

AD7893-68HC11 Interface

An interface circuit between the AD7893 and the 68HC11 microcontroller is shown in Figure 7. For the interface shown, the 68HC11 SPI port is used, and the 68HC11 is configured in its single-chip mode. The 68HC11 is configured in the master mode with its CPOL bit set to a logic zero and its CPHA bit set to a logic one. As with the previous interface, the diagram shows the simplest form of the interface where the AD7893 is the only part connected to the serial port of the 68HC11 and, therefore, no decoding of the serial read operations is required. It also makes no provisions for monitoring when conversion is complete on the AD7893.

Once again, either of these two tasks can readily be accomplished with minor modifications to the interface. To chip select the AD7893 in systems where more than one device is connected to the 68HC11's serial port, a port bit, configured as an output from one of the 68HC11's parallel ports, can be used to gate on or off the serial clock to the AD7893. A simple AND function on this port bit and the serial clock from the 68HC11 will provide this function. The port bit should be high to select the AD7893 and low when it is not selected.

To monitor the conversion time on the AD7893, a scheme such as outlined in the previous interface with $\overline{\text{CONVST}}$ can be used. This can be implemented in two ways. One is to connect the $\overline{\text{CONVST}}$ line to another parallel port bit that is configured as an input. This port bit can then be polled to determine when conversion is complete. An alternative is to use an interrupt driven system, in which case the $\overline{\text{CONVST}}$ line should be connected to the IRQ input of the 68HC11.

The serial clock rate from the 68HC11 is limited to significantly less than the allowable input serial clock frequency with which the AD7893 can operate. As a result, the time to read data from the part will actually be longer than the conversion time of the part. This means that the AD7893 cannot run at its maximum throughput rate when used with the 68HC11.

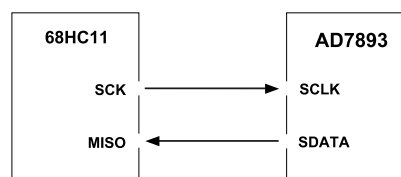

Figure 7. AD7893 to 68HC11 Interface

AD7893

AD7893-ADSP-2105 Interface

An interface circuit between the AD7893 and the ADSP-2105 DSP processor is shown in Figure 8. In the interface shown, the RFS1 output from the ADSP-2105's SPORT1 serial port is used to gate the serial clock (SCLK1) of the ADSP-2105 before it is applied to the SCLK input of the AD7893. The RFS1 output is configured for active high operation. The interface ensures a noncontinuous clock for the AD7893's serial clock input with only sixteen serial clock pulses provided, and the serial clock line of the AD7893 remaining low between data transfers. The SDATA line from the AD7893 is connected to the DR1 line of the ADSP-2105's serial port.

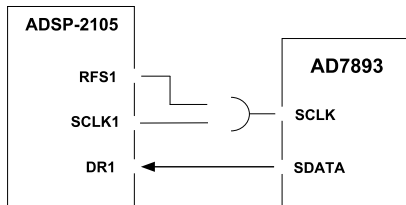

Figure 8. AD7893 to ADSP-2105 Interface

The timing relationship between the SCLK1 and RFS1 outputs of the ADSP-2105 are such that the delay between the rising edge of the SCLK1 and the rising edge of an active high RFS1 is up to 25 ns. There is also a requirement that data must be set up 10 ns prior to the falling edge of the SCLK1 to be read correctly by the ADSP-2105. The data access time for the AD7893 is 50 ns from the rising edge of its SCLK input. Assuming a 10 ns propagation delay through the external AND gate, the high time of the SCLK1 output of the ADSP-2105 must be $\geq (50 + 25 + 10 + 10)$ ns, i.e., ≥ 95 ns. This means that the serial clock frequency with which the interface of Figure 13 can work with is limited to 5.26 MHz.

An alternative scheme is to configure the ADSP-2105 to accept an external serial clock. In this case, an external noncontinuous serial clock that drives the serial clock inputs of both the ADSP-2105 and the AD7893 is provided. In this scheme, the serial clock frequency is limited to 5 MHz by the ADSP-2105.

To monitor the conversion time on the AD7893, a scheme such as outlined in previous interfaces with CONVST can be used. This can be implemented by connecting the CONVST line directly to the IRQ2 input of the ADSP-2105.

AD7893-DSP56000 Interface

Figure 9 shows an interface circuit between the AD7893 and the DSP56000 DSP processor. The DSP56000 is configured for normal mode asynchronous operation with gated clock. It is also set up for a 16-bit word with the gated serial clock being generated by the DSP56000 and appears on the SC0 pin. The SC0 pin should be configured as an output by setting bit SCD0 to 1. In this mode, the DSP56000 provides sixteen serial clock pulses to the AD7893 in a serial read operation. The DSP56000 assumes valid data on the first falling edge of SCK, so the interface is simply two-wire as shown in Figure 9.

To monitor the conversion time on the AD7893, a scheme such as outlined in previous interface examples with CONVST can be used. This can be implemented by connecting the CONVST line directly to the IRQA input of the DSP56000.

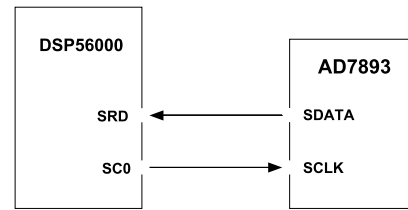

Figure 9. AD7893 to DSP56000 Interface

AD7893 PERFORMANCE

Linearity

The linearity of the AD7893 is determined by the on-chip 12-bit D/A converter. This is a segmented DAC that is laser trimmed for 12-bit integral linearity and differential linearity. Typical relative numbers for the part are $\pm 1/4$ LSB, while the typical DNL errors are $\pm 1/2$ LSB.

Noise

In an A/D converter, noise exhibits itself as code uncertainty in dc applications and as the noise floor (in an FFT, for example) in ac applications. In a sampling A/D converter like the AD7893, all information about the analog input appears in the baseband from dc to 1/2 the sampling frequency. The input bandwidth of the track/hold exceeds the Nyquist bandwidth; therefore, an antialiasing filter should be used to remove unwanted signals above $f_s/2$ in the input signal in applications where such signals exist.

Figure 10 shows a histogram plot for 8192 conversions of a dc input using the AD7893. The analog input was set at the center of a code transition. The timing and control sequence used was per Figure 3 where the optimum performance of the ADC was achieved. It can be seen that almost all the codes appear in the one output bin, indicating very good noise performance from the ADC. The rms noise performance for the AD7893-2 for the above plot was 87 μ V. Since the analog input range, and hence LSB size, on the AD7893-10 is eight times what it is for the AD7893-2, the same output code distribution results in an output rms noise of 700 μ V for the AD7893-10.

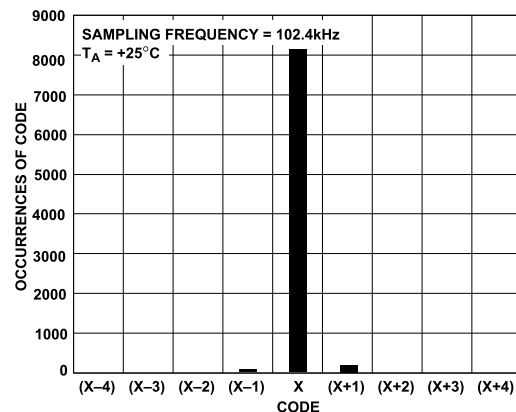

Figure 10. Histogram of 8192 Conversions of a DC Input

The same data is presented in Figure 11 as in Figure 10 except that, in this case, the output data read for the device occurs during conversion. This has the effect of injecting noise onto the die while bit decisions are being made; this increases the noise generated by the AD7893. The histogram plot for 8192 conversions of the same dc input now shows a larger spread of codes with the rms noise for the AD7893-2 increasing to 210 μ V. This effect will vary depending on where the serial clock edges appear with respect to the bit trials of the conversion process. It is possible to achieve the same level of performance when reading during conversion as when reading after conversion, depending on the relationship of the serial dock edges to the bit trial points.

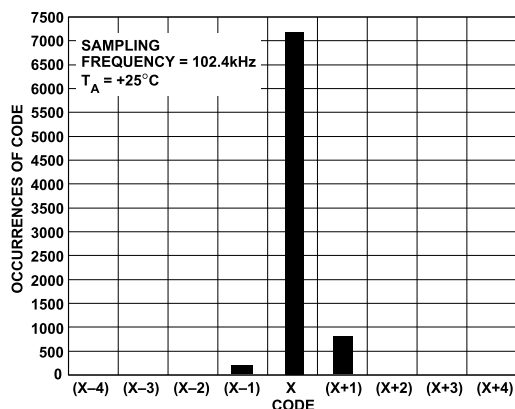

Figure 11. Histogram of 8192 Conversions with Read During Conversion

Dynamic Performance

With a combined conversion and acquisition time of 7.5 μ s, the AD7893 is ideal for wide bandwidth signal processing applications. These applications require information on the ADC’s effect on the spectral content of the input signal. Signal to (noise + distortion) ratio, total harmonic distortion, peak harmonic or spurious noise, and intermodulation distortion are all specified. Figure 12 shows a typical FFT plot of a 10 kHz, 0 V to +2.5 V input after being digitized by the AD7893-2, operating at a 102.4 kHz sampling rate. The signal to (noise + distortion) ratio is 71.5 dB, and the total harmonic distortion is -83 dB.

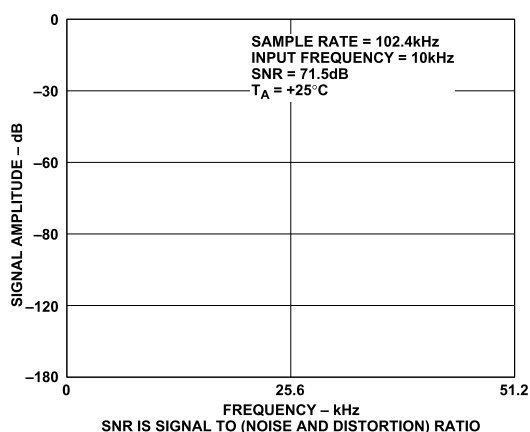

Figure 12. AD7893 FFT Plot

Effective Number of Bits

The formula for signal to (noise + distortion) ratio (see Terminology section) is related to the resolution or number of bits in the converter. Rewriting the formula gives a measure of performance expressed in effective number of bits (N):

$$N = (SNR - 1.76) / 6.02$$

where SNR is Signal to (Noise + Distortion) Ratio.

The effective number of bits for a device can be calculated from its measured signal to (noise + distortion) ratio. Figure 13 shows a typical plot of effective number of bits versus frequency for the AD7893-2 from dc to $f_{\text{SAMPLING}}/2$. The sampling frequency is 102.4 kHz. The plot shows that the AD7893 converts an input sine wave of 51.2 kHz to an effective numbers of bits of 11, which equates to a signal to (noise + distortion) level of 68 dB.

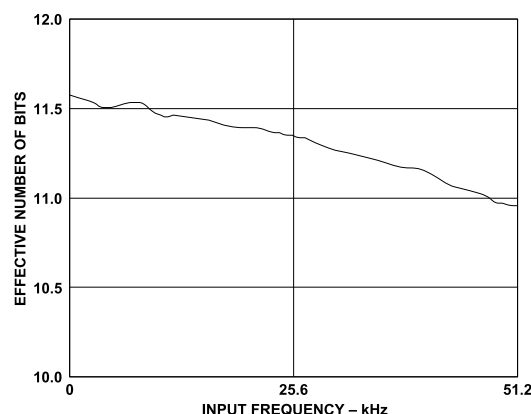
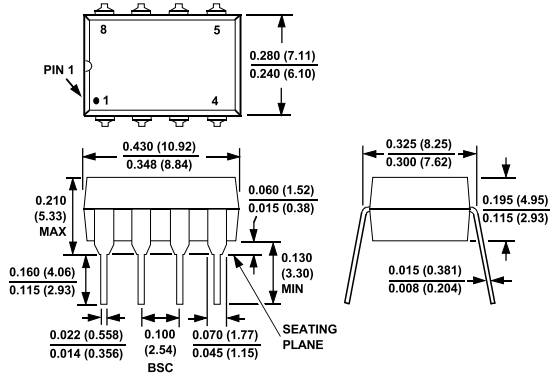

Figure 13. Effective Number of Bits vs. Frequency

OUTLINE DIMENSIONS
Dimensions shown in inches and (mm).

Plastic DIP (N-8)



Cerdip (Q-8)

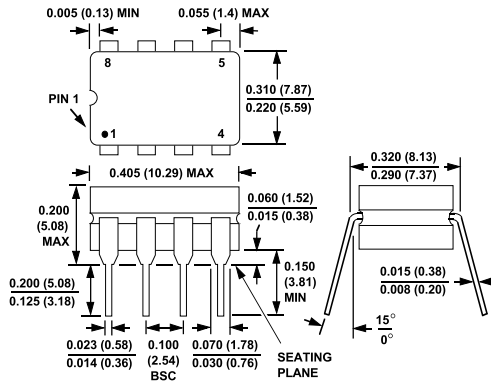

SOIC (SO-8)

