

REV.	DESCRIPTION	DRAWN	CHECKED	APPROVED
A	NEW RELEASE	LL 09/11/06'		

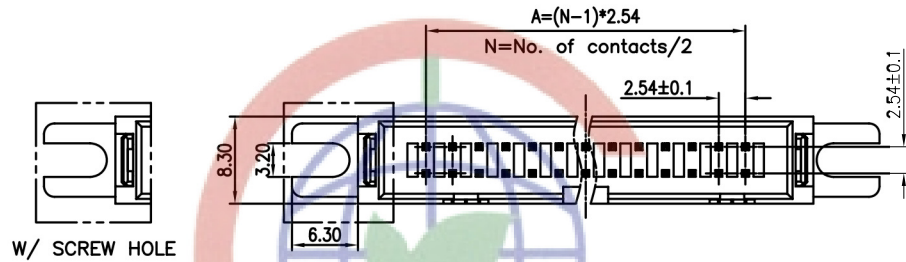

W/ SCREW HOLE

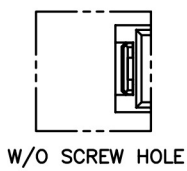

W/O SCREW HOLE

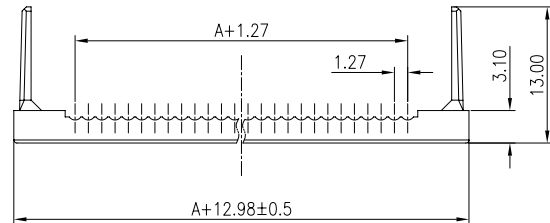
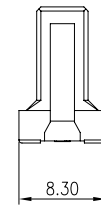
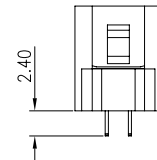
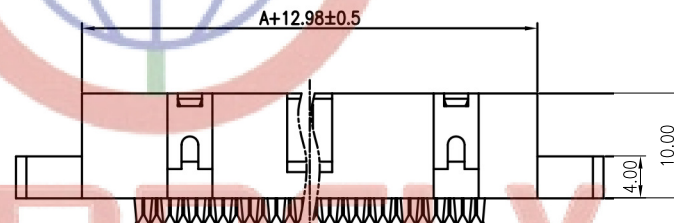

COVER

NOTES:

- MATERIAL
 - INSULATOR:THERMOPLASTIC(UL 94V-0).
 - CONTACT: COPPER ALLOY.
- SPECIFICATION
 - STORAGE TEMPERATURE:-20-70°C.
 - OPERATING TEMPERATURE:0-85°C.
 - CONTACT RESISTANCE:20mΩ max.
 - INSULATION RESISTANCE:1000MΩ min.
 - DIELECTRIC WITHSTANDING VOLTAGE:AC 500V PER MINUTE.

3. PART NUMBER: DS1015

4. PRODUCT NUMBER CODE:
 DS1015- X X X X

- HOUSING COLOR
A:GRAY
- CONTACT PLATING
0: SELECTIVE GOLD FLASH
- STRAIN RELIEF
M:W/
N:W/O
- SCREW HOLE
M:W/
N:W/O
- No. OF CONTACTS
10 14 16 20 24 26
30 34 40 50 60 64
- SERIES No.
DS1015

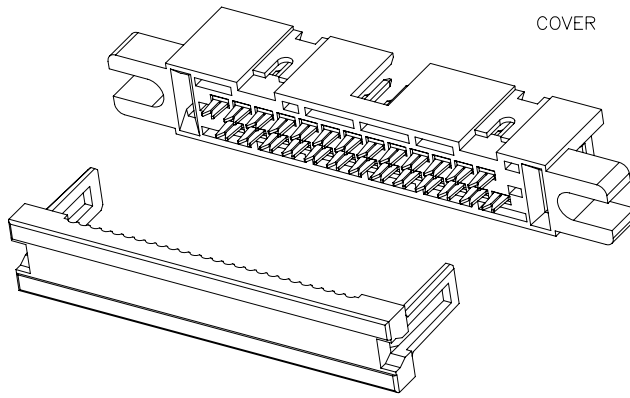

Tel: 86-574-63508787
 Fax: 86-574-63510817

GENERAL TOLERANCE		ANGLE TOLERANCE		PROJECTION	TITLE	IDC SHROUDED HEADER MATES WITH PITCH 1.27mm FLAT CABLE	
X.	±0.60	X.	±5'	UNITS	mm		
.X	±0.38	.X	±3'	SHEET SIZE	A4	SERIES	DS1015 SERIES
.XX	±0.25	.XX	±2'				
DRAWING TYPE	CUSTOMER	SHEET		1 OF 1			
SCALE	1:1	DRAWING NO.		C-DS1015-XXXXX			

晨翔电子有限公司
 CONNFLY CONNFLY ELECTRONIC CO. LTD